

GTI EL5

gerflor.com



Gerflor[®]
theflooringroup

APPLICATIONS

A solution for all markets



LABORATORIES



ATEX AREAS



ESD AREAS





AGV (AUTOMATIC GUIDED VEHICLES) AREAS



DATA ROOMS / DATA CENTRES



CLEANROOM & HEALTHCARE ENVIRONMENTS

All the benefits of a GTI Tile with Evercare™ treated smooth surface and electro-conductive properties.

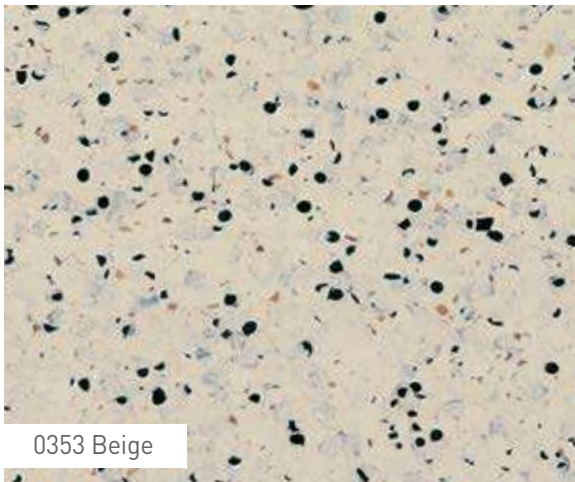
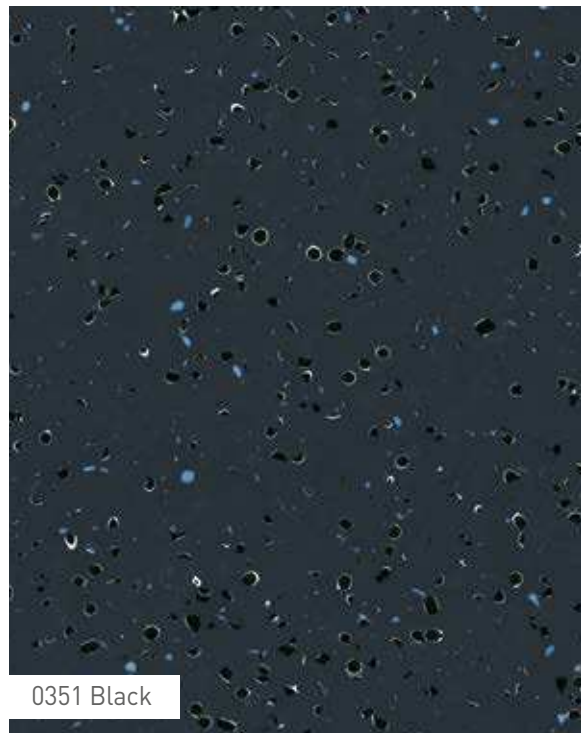
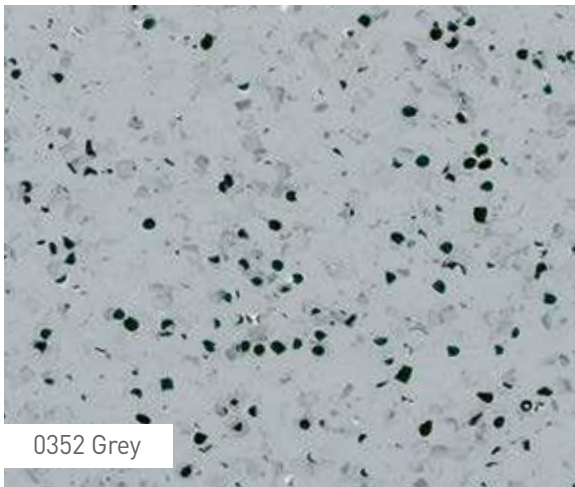
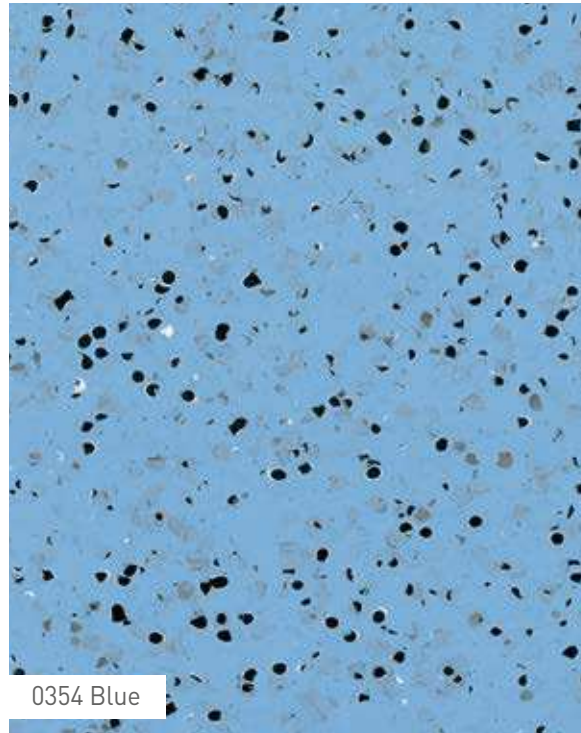
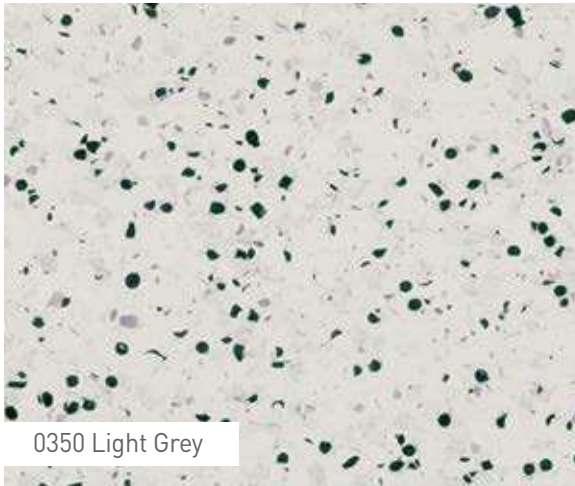

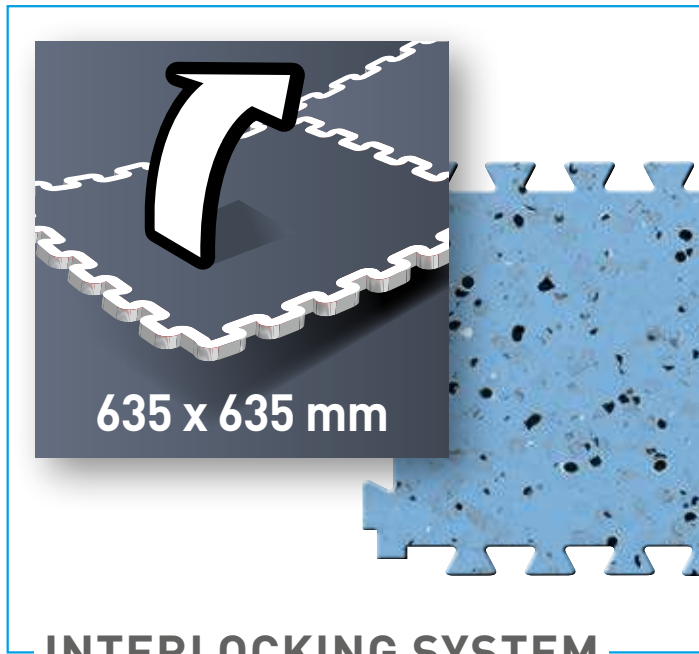

635 x 635 mm

INTERLOCKING SYSTEM

GTI EL5 CONNECT

OR

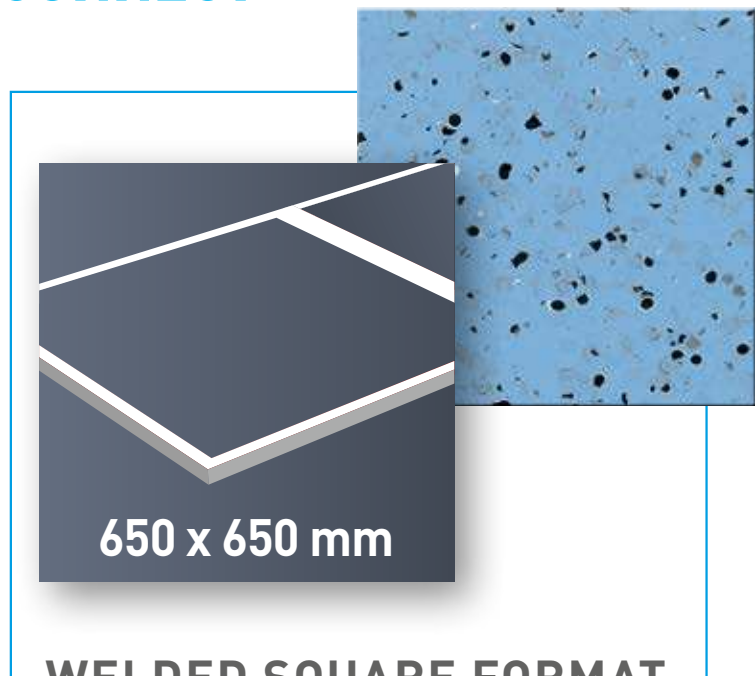

650 x 650 mm

WELDED SQUARE FORMAT

GTI EL5 CONTROL

ALL THE BENEFITS OF A GTI TILE...



- ▶ **Renovation solution**
- ▶ **Easy repairs** with no special tools / **Easy replacement**
- ▶ **Direct installation** on existing floor (concrete, ceramic, epoxy resin, pvc, ...) or problem subfloors (asbestos subfloor, damp subfloor, ...)



- ▶ **Fast & Easy Installation** up to 20 sqm / 215 sq. ft. per hour
- ▶ **No shut down required**
- ▶ **No lost revenues + Time saving**



- ▶ **High Traffic Resistance**
- ▶ **Withstands heavy loads**
- ▶ **Durability** will not crack / will not blister / will not break



- ▶ **Watertight System** (hot welding) with GTI EL5 Control



- ▶ **Environmentally Friendly**
 - Adhesive free
 - "VOC free" system (TVOC <math>< 10\mu\text{g}/\text{m}^3</math> & adhesive free)
 - 100% recyclable
 - Above 50% recycled content
 - Extremely low usage of chemical products and water for maintenance



(1) Patent pending



... WITH **EVERCARE™** TREATED SMOOTH SURFACE...



- ▶ Easy maintenance
- ▶ No wax for life
- ▶ Stain barrier
- ▶ Chemical resistance



- ▶ **Complete finishes package**
to offer full coving system together
with GTI Control (heat welded).
100% watertight and full hygienic
solution to meet all clean
environments requirements

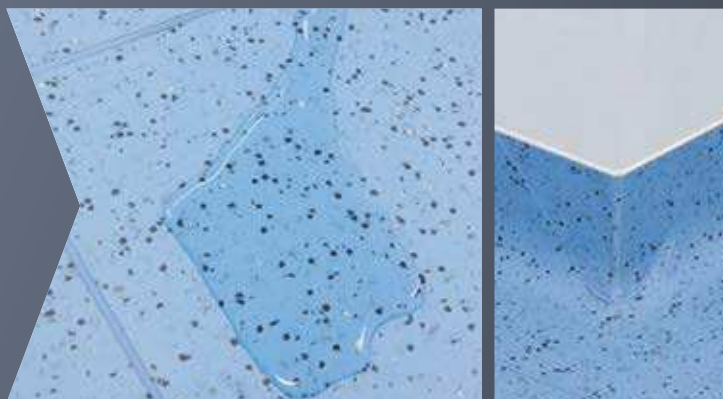

evercare™



(1) Patent pending

... AND ELECTRO-CONDUCTIVE PROPERTIES

- ▶ $5 \times 10^4 \leq R_t \leq 10^6$ (EN1081 – IEC61340-4-1)
conductive properties throughout its full life expectancy
- ▶ **Low static electrical propensity:**
<2000V (EN1815), <100 V (IEC61340-4-5).





GTI EL5 FINISHES

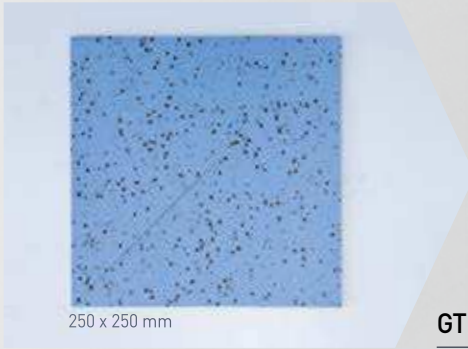

250 x 250 mm

GTI EL5 CONTROL - COVING CORNER OUT

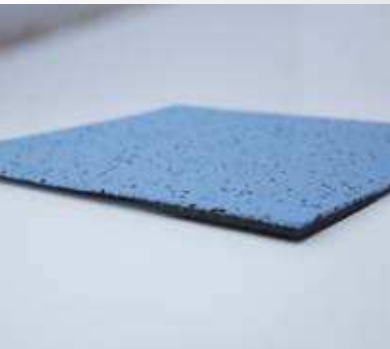

250 x 250 mm

GTI EL5 CONTROL - COVING CORNER IN

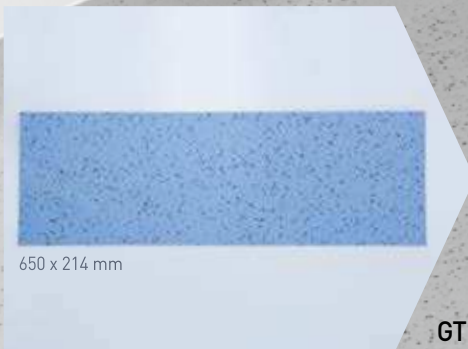

650 x 214 mm

GTI EL5 CONTROL - COVING



Diameter: 4.1 mm / ≈100 lm per roll

GTI EL5 CONTROL - WELDING ROD

WARNING: GTI EL5 welding rods surface is black. The colour will be revealed when the installer cuts and trims the welding rods.



ESD COPPER STRIP

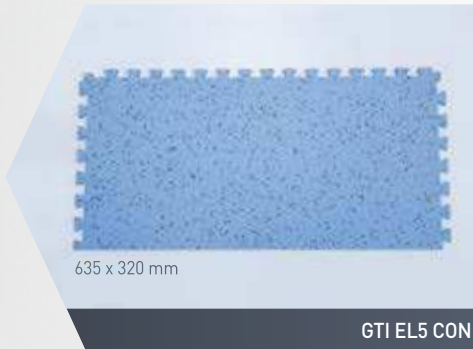

635 x 320 mm

GTI EL5 CONNECT - ACCESS

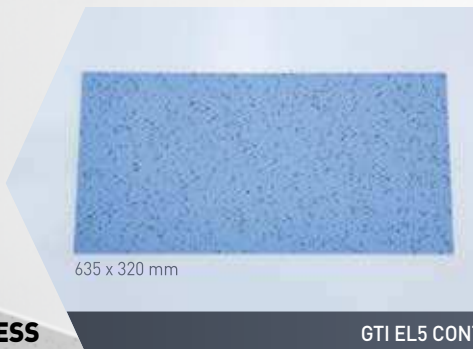

635 x 320 mm

GTI EL5 CONTROL - ACCESS



GTI EL5 ACCESS

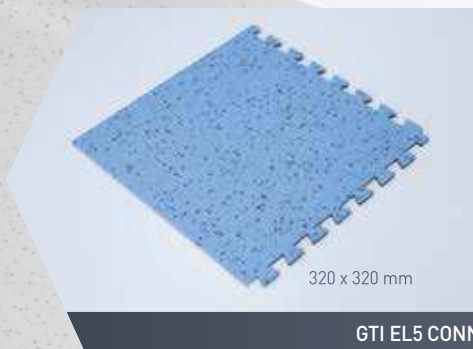

320 x 320 mm

GTI EL5 CONNECT - CORNER

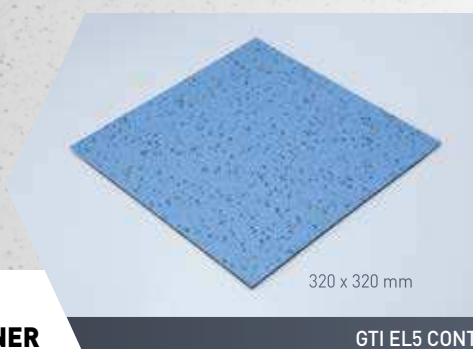
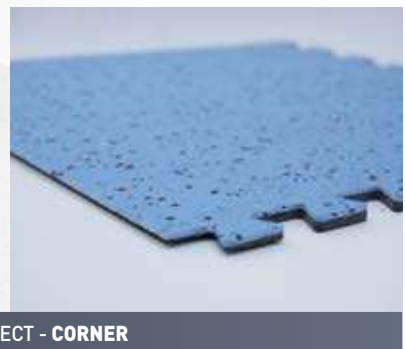

320 x 320 mm

GTI EL5 CONTROL - CORNER



GTI EL5 CORNER

GTI EL5

CONTROL

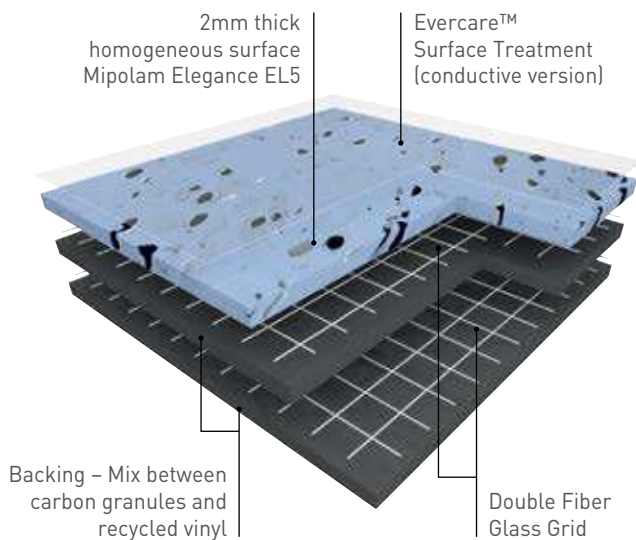

CONNECT

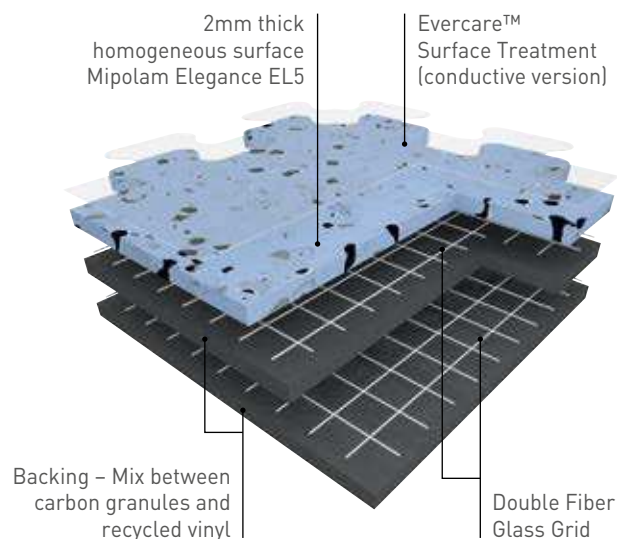

GTI EL5 is a multi-layered loose lay vinyl tile, 6 mm thick, reinforced with 2 glass fibre grids.

GTI EL5 tiles can be installed using interlocking system with dove tails (**GTI EL5 CONNECT**).

They are also available in **square format with welded joints** for clean environments and watertight systems requirements (**GTI EL5 CONTROL**).

GTI EL5 wearlayer is 2 mm vinyl homogeneous manufactured with continuous high pressure process, abrasion group P.

It complies with EN 649 and offers an outstanding resistance to traffic.

This floorcovering is treated with **Evercare™** technology: the latest improvements in polyurethane surface treatment obtained by UV laser cross-linking. Evercare™ offers easy maintenance and avoids staining of chemical products used in industry and healthcare, like betadine, eosin, anti-bacterial hand gel and also bio-decontamination procedures.

This treatment has excellent maintenance characteristics; it requires no wax for life!

The carbon encapsulated granules throughout its full thickness and the **conductive backing** and **conductive surface treatment** ensure optimal and consistent conductive properties throughout its full life expectancy.

GTI EL5 acts as a continuous conductive: $5 \times 10^4 \leq Rt \leq 10^6$ (EN1081 – IEC61340-4-1 $\leq 10^8$).

It has permanent antistatic properties: **<2000V (EN1815), <100 V (IEC61340-4-5)**.

The product is non-emissive of volatile organic compounds with <10 µg/m³ (TVOC after 28 days ISO 16000-6).

Complementary finishes: GTI EL5 ACCESS (access ramp), GTI EL5 CORNER (corner finishes), GTI EL5 CONTROL coving (COVING / COVING CORNER IN and COVING CORNER OUT) and conductive welding rods (GTI EL5 CONTROL WELDING RODS).

 CONTROL 650 x 650 mm	 CONNECT 635 x 635 mm	Removable	R9	Evercare™	 100% recyclable
--	--	------------------	-----------	------------------	--

GTI EL5

DESCRIPTION

Total thickness	EN ISO 24346 (EN 428)	mm	6
Wearlayer thickness	EN ISO 24340 (EN 429)	mm	2
Weight	EN ISO 23997 (EN 430)	g/m ²	9240
Size	EN ISO 24342 (EN 427)	mm	635 x 635 (GTI EL5 CONNECT) 650 x 650 (GTI EL5 CONTROL)

CLASSIFICATION

Norm / Product specification	-	-	EN ISO 10582 (EN 649)
European classification	EN ISO 10874 (EN 685)	Class	34-43
Fire rating	EN 13 501-1	Class	B _{fl} -s1
Electrical resistance	EN 1081 IEC 61340-4-1 IEC 61340-4-5 ANSI / ESD 7.1	Ω	$5 \times 10^4 \leq R_t \leq 10^6$ $\leq 10^9$ $\leq 10^9$ $2.5 \times 10^4 \leq R_t \leq 10^6$
Static electrical propensity	EN 1815 IEC 61340-4-5	kV V	< 2 ≤ 100 ⁽¹⁾
Protection against electrostatic discharges	ESD S20.20 IEC 61340-5-1	- -	OK OK
Slip resistance wet: ramp test with oil	DIN 51 130	Class	R9

PERFORMANCES

Wear resistance	EN 660.2	mm ³	≤ 4
Wear group	(EN 649)	-	P
Type Binder content	ISO 10581 / 10582	type	I
Dimensional stability	EN ISO 23999 (EN 434)	%	≤ 0.25
Shore Hardness D	EN ISO 868	HD	≥ 90
Castor chair test (type W)	ISO 4918 (EN 425)	-	OK
Thermal conductivity	EN ISO 10456 (EN 12524)	W/(m.K)	0.25
Colour fastness	EN 20 105 - B02	Degree	≥ 6
Surface treatment	-	-	Evercare™
Chemical product resistance	EN ISO 26987 (EN 423)	-	good

ENVIRONMENT / INDOOR AIR QUALITY

TVOC after 28 days	ISO 16000-6	µg / m ³	<10
Certification	-	-	Floorscore®

CE MARKING

	EN 14041	  
		

(1) Measured with ESD shoes (type ABEBA and UVEX).

gerflor.com

ARCHITECTURE
DECORATION
SPORT
TECHNOSPECIFIC

ASIA: Gerflor Asia

Tel: +86 21 6357 8818 - Fax: +86 21 6357 8998
e-mail: gerflorasia@gerflor.com

AUSTRALIA/NEW ZEALAND: Gerflor Australasia Pty. Ltd
Australia Tel: 1 800 060 785 - New Zealand Tel: 0 800 630 119
e-mail: gerflor@gerflor.com.au

AUSTRIA/SWITZERLAND: Gerflor GmbH
Tel: +43 (0)72 29/70 800-0 - Fax: +43 (0)72 29/70 800-218
e-mail: austria@gerflor.com - switzerland@gerflor.com

BELGIUM/LUXEMBURG: Gerflor Benelux
Tel: +32 (0)3 766 42 82 - Fax: +32 (0)3 766 29 14
e-mail: gerflorbel@gerflor.com

CANADA: Gerflor Canada
Tel: +1 438 333 0752 - Fax: +1 438 380 5425
e-mail: gerflorcanada@gerflor.com

CHINA: Gerflor floorings (China) Co. Ltd.
Tel: +86 21 6357 8818 - Fax: +86 21 6357 8998
e-mail: gerflorchina@gerflor.com

FINLAND: Gerflor Oy
Tel: +358 (0) 10 6 17 5150 - Fax: +358 (0) 10 617 5152
e-mail: info@gerflor.fi

FRANCE: Gerflor - Service Express:
 N° Azur 0 810 569 569  N° Azur FAX 0 810 569 570
e-mail: contactfrance@gerflor.com

GERMANY: Gerflor Mipolam GmbH
Tel: +49 (0)22 41-25 30-0
e-mail: gerflormipolam@gerflor.com
Kunden-Service
Tel: +49 (0) 22 41-25 30-136 - Fax: +49 (0) 22 41-25 30-100
e-mail: kundenservice@gerflor.com
SAT Service und Anwendungstechnik
tel: +49 (0)22 41-25 30 555 - Fax: +49 (0)22 41-25 30 550
e-mail: technik@gerflor.com

IRELAND: Gerflor Ltd
Tel: +353 (0) 42 966 1431 - Fax: +353 (0) 42 966 1759
e-mail: gerflorirl@gerflor.com

ITALY: Gerflor S.p.A.
Tel: +39 02 90 40 10 - Fax: +39 02 90 42 74 84
e-mail: gerfloritalia@gerflor.com

LATIN AMERICA (Brazil): Gerflor América Latina
Tel: +55 11 38 48 20 20
e-mail: gerflor@gerflor.com.br

MIDDLE EAST: Gerflor Middle East
Tel: +966 13 847 1779 - Fax: +966 13 847 1781
e-mail: info@gerflorme.com

NETHERLANDS: Gerflor Benelux
Tel: +31 (0)40 266 17 00 - Fax: +31 (0)40 257 46 89
e-mail: gerflornl@gerflor.com

OTHER COUNTRIES: Gerflor International
Tel: +33 (0)4 74 05 40 00 - Fax: +33 (0)4 74 05 03 13
e-mail: gerflorcontract@gerflor.com

POLAND: Gerflor Polska Sp z o.o
Tel: + 48 61 823 34 01 - Fax: + 48 61 823 34 33
e-mail: info@gerflor.pl

PORTUGAL: Gerflor Iberia, SA
Tel: +351 21 843 95 49 - Fax: +351 21 846 55 44
e-mail: gerflorportugal@gerflor.com

RUSSIA: Gerflor zao
Tel./Fax: + 7 495 785 23 71
e-mail: gerflorrussia@gerflor.ru

SCANDINAVIA: Gerflor Scandinavia a.s.
Tel: + 47 64 95 60 70 - Fax: + 47 64 95 60 80
e-mail: gerflorscand@gerflor.no

SPAIN: Gerflor Iberia, SA
Tel: +34 91 653 50 11 - Fax: +34 91 653 25 85
e-mail: gerfloriberia@gerflor.com

UNITED KINGDOM: Gerflor Ltd
Sample service: Contractuk@gerflor.com
Office Tel: + 44 (0) 1926 622 600 - Fax: + 44 (0) 1926 401 647

USA: Gerflor North America
Tel: 877 GERFLOR (437 3567) - Fax: 847 394 3753
e-mail: info@gerflorusa.com



Gerflor. Don't forget our complementary ranges!



Handrails



Wall Coverings & Protections



Entrance mats



Skirtings & Profiles

and Be CONNECTED!



www.gerflor.com

Gerflor[®]
theflooringgroup