

GTV
LIGHTING





GTV
LIGHTING

GTV Poland to międzynarodowy producent i jedna z czołowych firm na polskim rynku oświetlenia. Oferuje pełną gamę produktów - od źródeł światła po przeznaczone dla konkretnej inwestycji rozwiązania oświetleniowe. Portfolio - jedno z bardziej kompletnych na rynku - obejmuje kilka tysięcy produktów w kilkudziesięciu grupach produktowych. GTV Poland to nowoczesna i profesjonalnie zarządzana firma, a jednocześnie zaufany partner biznesowy dla kontrahentów na całym świecie.

GTV Poland is an international producer and one of the leaders in the Polish lighting market. The Company offers a complete range of products - from light sources to those designed for specific investment lighting solutions. The Portfolio - one of the most extensive in the market - is comprised of thousands of products in several dozen product groups. GTV Poland is a modern company with professional management and, at the same time, a reliable worldwide business partner.

GTV Poland - это международный производитель и одна из ведущих компаний на польском рынке освещения. Компания предлагает полный спектр продуктов - от источников света по предназначенное для конкретной инвестиции комплексное освещение. Портфолио - одно из самых полных на рынке - включает в себя несколько тысяч продуктов, в нескольких десятках группах продукции. GTV Poland - это современная и профессионально управляемая компания, одновременно она является надежным деловым партнером для подрядчиков по всему миру.

GTV Poland - це міжнародний виробник і одна з провідних компаній на польському ринку освітлення. Фірма пропонує повний спектр освітлювального обладнання - від світлодіодних лампочок, до продуктів, призначених для конкретних інвестиційних проєктів. Портфоліо - одно з найбагатших на ринку - включає в себе декілька тисяч продуктів, в десятках продуктової груп. GTV Poland це сучасна і професійно керована компанія, одночасно вона є надійним діловим партнером для клієнтів по всьому світу.

PL

EN

RU

UK

ŹRÓDŁA ŚWIATŁA

LAMPS

ИСТОЧНИКИ СВЕТА

ДЖЕРЕЛА СВІТЛА 18

Źródła światła LED Led lamps Светодиодные источники света Світлодіодні джерела світла.....	21
---	----

Świetłówki LED typu T8 T8 led tubes Светодиодная лампа типа T8 Світлодіодні лампи типу T8	47
--	----

**OPRAWY TECHNICZNE I PRZEMYSŁOWE
TECHNICAL AND INDUSTRIAL FIXTURES
ТЕХНИЧЕСКИЕ И ПРОМЫШЛЕННЫЕ СВЕТИЛЬНИКИ
ТЕХНІЧНІ ТА ПРОМИСЛОВІ СВІТИЛЬНИКИ 54**

Panele i oprawy LED LED Panels and LED Fixtures Светодиодные панели Світлодіодні панелі	57
--	----

Оправы промышленные LED Industrial fixtures Светодиодные промышленные светильники Світлодіодні промислові світильники	68
--	----

Plafoniere i oprawy kanałowe LED LED Ceiling fixtures & bulkhead fixtures Светодиодные светильники и светильники ЖКХ Світлодіодні світильники та світильники ЖКХ.....	78
--	----

Оправы LED typu downlight Downlights Светильники типа downlight Світильники типу downlight	96
---	----

Naświetlacze LED Floodlights Светодиодные прожекторы Світлодіодні прожекторы	114
---	-----

Оправы LED typu high bay High bay LED luminaires Светодиодные High bay светильники Світлодіодні high bay світильники	120
---	-----

Оправы уличные и парковые LED Street and park luminaires LED Светодиодные уличные и парковые светильники LED Світлодіодні вуличні та паркові світильники	124
---	-----

Оправы аварийные LED Emergency light fixtures Аварийные светильники Аварійні світильники	128
---	-----

Оправы рastroвые, kłoszowe Louvre fittings Растровые светильники Растрові світильники	132
--	-----

Оправы промышленные Industrial fixtures Промышленные светильники Промислові світильники	136
--	-----

Plafoniere i oprawy kanałowe Ceiling fixtures & bulkhead fixtures ЖКХ светильники ЖКГ світильники	140
--	-----

Оправы мастерские и лампы LED Workshop fixtures & led flashlights Светильники для мастерской и LED-фонари Світильники для майстерень та світлодіодні ліхтаріки	148
---	-----

**OPRAWY DEKORACYJNE
DECORATIVE FIXTURES
ДЕКОРАТИВНЫЕ СВЕТИЛЬНИКИ
ДЕКОРАТИВНІ СВІТИЛЬНИКИ 156**

Оправы точечные Spot light fixtures Точечные светильники Точкові світильники	186
---	-----

Oprawy sufitowe Ceiling fixtures Потолочные светильники Світильники стельові	159
---	-----

Oprawy ogrodowe i elewacyjne Garden and wall-mounted fixtures Садовые и фасадные светильники Садові та фасадні світильники	209
---	-----

Lampki Desk lamps Настольные лампы Лампи настільні	228
---	-----

SYSTEMY SZYNOWE TRACK SYSTEMS ТРЕКОВЫЕ СИСТЕМЫ ОСВЕЩЕНИЯ ТРЕКОВІ СИСТЕМИ ОСВІТЛЕННЯ	232
--	------------

Reflektory LED Spot lights LED Светодиодные лампы Світлодіодні трекові світильники	235
---	-----

Szynoprzewody Track systems Шинопровод Шинопровід	240
--	-----

OSPRZĘT ELEKTROINSTALACYJNY INSTALLATION FITTINGS ЭЛЕКТРОУСТАНОВОЧНЫЕ ИЗДЕЛИЯ ЕЛЕКТРОМОНТАЖНІ ВИРОБИ	254
---	------------

Osprzęt elektroinstalacyjny Installation fittings Электроустановочные изделия Електромонтажні вироби	255
---	-----

OŚWIETLENIE MEBLOWE / PROFILE LED FURNITURE LIGHTING / LED PROFILES ОСВЕЩЕНИЕ МЕБЕЛИ / ПРОФИЛИ ДЛЯ СВЕТОДИОДНЫХ ЛЕНТ ОСВІТЛЕННЯ МЕБЛІВ / ПРОФІЛЬ ДЛЯ СВІТЛОДІОДНОЇ СТРИЧКИ	294
---	------------

Taśmy LED / Profile LED LED strips / LED profiles Светодиодные ленты / Профили LED Стрічки LED / Профілі LED	297
---	-----

Oprawy LED LED fixtures Светодиодные светильники Світлодіодні світильники	322
--	-----

Aksesoria Accessories Аксессуары Аксесуари	342
---	-----

Przedłużacze Power sockets Удлинитель Подовжувачн	370
--	-----













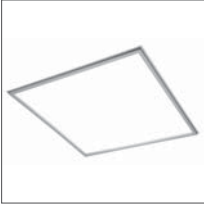















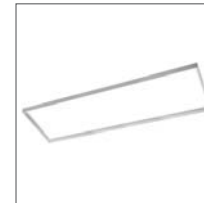









Źródła światła
Lamps
Источники света
Джерела світла

					
LD-SMGC30B 24	LD-SMDC37 24	LD-C35FL4M 24	LD-C35FL4 25	LD-SMGC30L 25	LD-SMC37L 25
					
LD-C35FL4M 26	LD-C35FL4 26	LD-SMGB45B 26	LD-SMB45B 27	LD-G45FL4M 27	LD-G45FL4 27
					
LD-E14S2W0 28	LD-E14P35W 28	LD-R5060W 28	LD-R6380W 29	LD-A60CZ3 29	LD-A60CM3 29
					
LD-PC2A60RGBW 30	LD-3SCTA60 30	LD-3SDA60 30	LD-DC24A60 32	LD-SPCA60 32	LD-PC2A60 32
					
LD-PC2A60 33	LD-PC3A60 33	LD-PC2A60 33	LD-PC3A60 34	LD-AL7A60 34	LD-A60FL8M 34
					
LD-A60FL8 35	LD-G95FL8 35	LD-G125FL8 35	LD-ST64FV4 36	LD-G95FV4 36	LD-G125FV4 36

					
LD-120G14W 38	LD-G45FL2E 38	LD-SMGC30C 38	LD-SMGB45C 39	LD-SMBD45 39	LD-UFO18W 39
					
LD-ALF100 40	LD-ALF140 40	LD-G93W25 41	LD-G93W24 41	LD-G96440 41	LD-G9P35W 42
					
LD-G9P5W0 42	LD-G9P7W0 42	LD-SPCGU10 43	LD-NGU10PN 43	LD-SZ1510 43	LD-SZ5010 44
					
LD-PC6010 44	LD-PC7510 44	LD-SM1210 45	LD-J7806W 45	LD-J11810W 45	LD-ES11100 46
					
LD-ES11177 46	LD-ES11110 46	LD-AR11120 47	LD-SM4016 47	LD-SM6016 47	LD-G4S115 48
					
LD-G4P35W 48	LD-G4015W 48	SW-NPC09WNB 51	SW-NSZT810W 51	SW-HLSZT809W 52	



Oprawy techniczne i przemysłowe
Technical and industrial fixtures
Технические и промышленные светильники
Технічні та промислові світильники

					
LD-AKO4060 58	LD-TIG34W60 58	LD-LN36W60 59	LD-LN40W60UGR 59	LD-GL40060 60	LD-GL40060UGR 60
					
LD-KNG24063 62	LD-KNG45060 62	LD-DE40062 64	LD-DE40062UGR 64	LD-VE4060W-50 65	LD-VE2060N-25 65
					
LK-PANELX4-00 66	ZM-PANELSC-00 66	ZM-PANELSU-00 66	RM-TIG60X60-00 67	RM-DE625X625-00 67	LD-BERGA50W-30 69
					
LD-BETISD50W-30 69	LD-HER60W12-NB 70	LD-OMN060-30B 72	LD-OMN120-75M 72	LD-LUM120-30P 73	LD-ZFPL24W06-NB 73
					
LD-ONT120-36 74	LD-ONTEND-00 74	LD-OLL20W-CB 75	LD-JAS15W-40 75	LD-NPCT809W-40 76	LD-NPCT836W-40 76
					
LD-BES24WOK-30 79	LD-BES24WKW-30 79	LD-STARS24W-NB 80	LD-MOON12W-NB 82	LD-ATL16OK-40 82	LD-ATL16KW-40 83

					
LD-SATU12W-NB 83	LD-EMP24W-40 84	LD-EMP24W-40KW 84	LD-EMP24WM-40 85	LD-EMP24WM-40KW 85	LD-TOK22W-00 86
					
LD-TOK16WD-40 86	LD-TOK16WP-40 87	LD-OSA16WD-40 87	LD-WENUSD13-LED 88	LD-WEND13W-40 89	LD-WENDM18W-40 89
					
LD-LOG16W-LED 90	OS-ITL12W-LED 90	OS-ITL12WKW-LED 91	LD-MCR12W-NB 91	LD-KALU10OK-40 92	LD-KALU10OW-40 92
					
LD-TW110WOK-40 93	LD-TW110WOW-40 93	LD-DELOR6W0-NB 94	LD-DELOW6W0-NB 94	LD-DELOR6WC-NB 95	LD-DELOW6WC-NB 95
					
LD-ORN07W-CBP 97	LD-ORW03W-CBP 97	LD-MAN07W-CBP 99	LD-MAW03W-CBP 99	LD-MZ12WOK-NB 100	LD-MZ12WKW-NB 100
					
LD-SMBOK09W-21 101	LD-SMBKW09W-21 101	LD-BLROK18W-61 102	LD-BLRK18W-61 102	LD-TWN09W-CB 104	LD-TWW09W-CB 104
					
LD-SO206W-NB 106	LD-VEW06W-CB 106	LD-VLROK0538-CB 108	LD-VLRKW0538-CB 108	LD-TOR08W-NB 110	LD-ARZ18W-CCT 110



LD-FAR10W-40 112



LD-KAR18W-CCT 112



LD-ALT20W-NB 113



LD-ARC15W-NB 113



LD-VIPERS30W-40 115



LD-IMAXC200W-64 115



LD-INEXT10W-64 116



LD-INEXT30WP-64 116



LD-ILUXC10W-64 118



LD-ILUXC100W-64 118



LD-HB150W-40 121



RF-HB150W-40 121



LD-TK100W-40 122



SO-TK060DE-00 122



LD-KAN150W-NB 123



LD-DAL100W-NB 123



LD-PARK2L30W-40 125



LD-STEL080W-40 125



LD-LUR050W-40 126



SA1 126



LD-SAHER1-DUO 129



OA-SEALED1-08 129



LD-TERNO1-00 130



LD-CORSO1-00 130



LD-OGLA3W-00 131



OS-LE150NJ-01 133



OS-OSL2120S-00 134



LD-OZE218-00 137



LD-OZE218-01 137



LD-HAG136-30 138



LD-HEL136B-30 138



LD-HAG236KL-ME 139



OS-HERZW1-00 139



OS-PLCRKM-00 141



OS-PLCZMI-00 141



OS-PLCRKZ-00 142



OS-PSL02E27-80 142



OS-PSLX2E27-80 143



OS-RING01 143



OS-IBBL060 144



OS-IBKR060 144



OS-KACROO 145

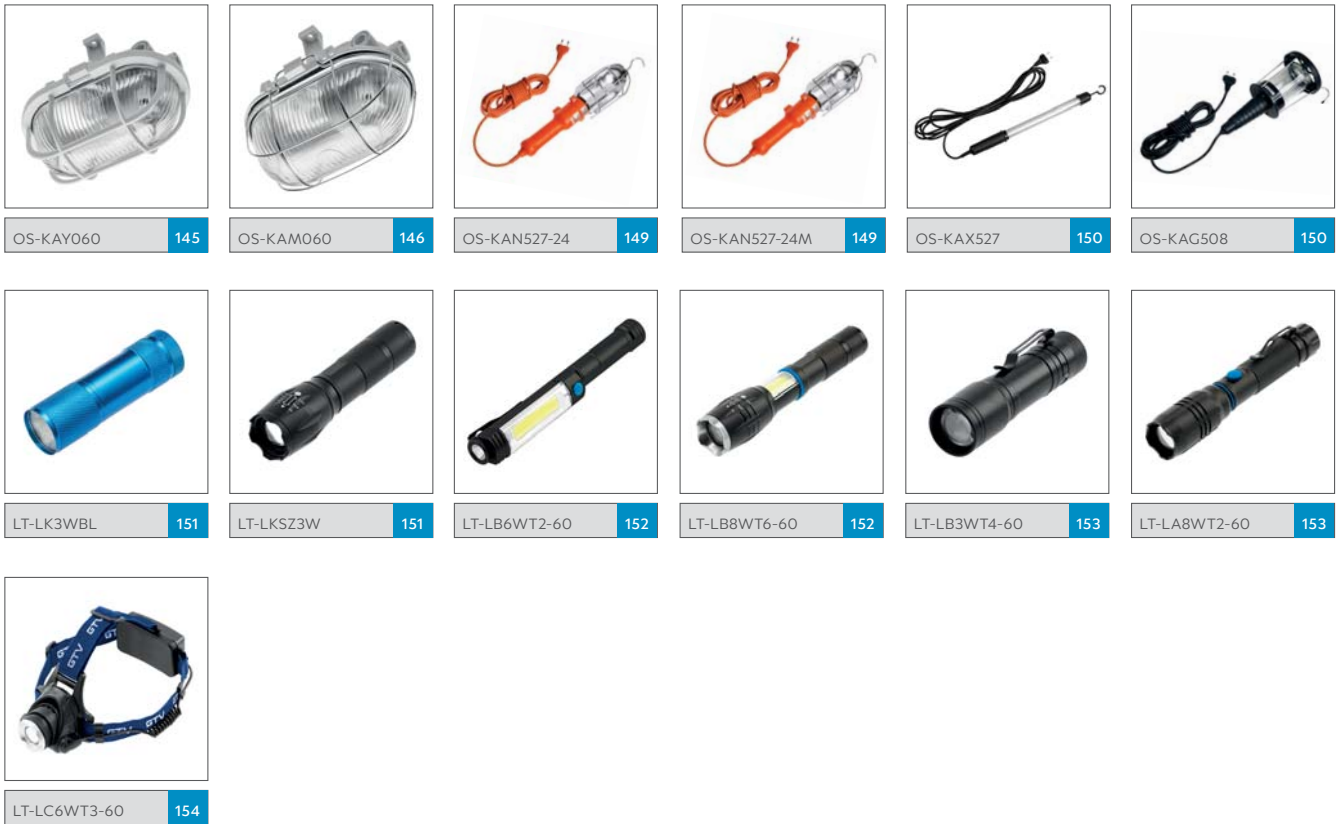

Опrawy dekoracyjne
Decorative fixtures
Декоративные светильники
Декоративні світильники

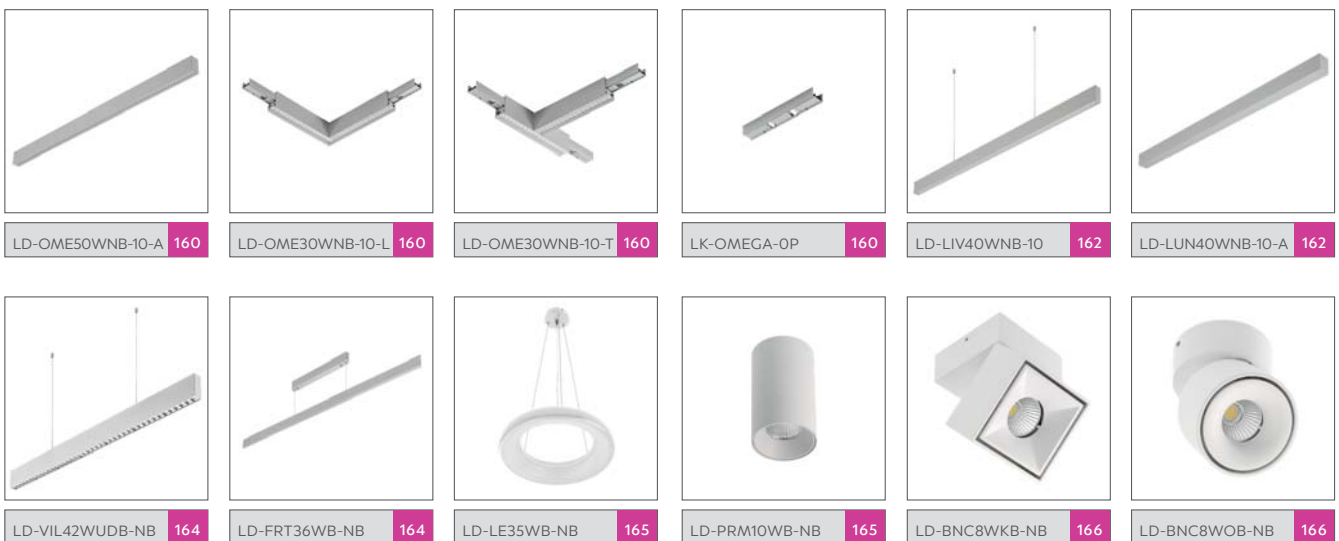

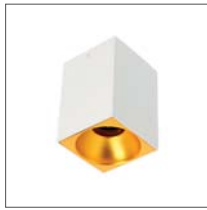

OS-TENGU10KW-10 167



OS-TENGU10-10 167



OS-AER20W-10 168



OS-LAG20W-10 168



OS-AV8085OK1-10 169



OS-AV8085KW1-10 169



OS-AV80160OK2 170



OS-AV80160KW2 170



OS-SENM5081OKCZ 172



OS-SENM5091KWB 172



OS-SEN5087OKCZ 173



OS-SEN5097KWB 173



OS-SEND5083OKB 174



OS-DRAGO14-10 174



OS-BLN50W1-10 176



OS-BLN50W2-10 177



OS-BLN50W3-10 177



OS-FRG20W-10 178



OS-FRG20W-10-MINI 178



OS-SAN20WOK1-10 179



OS-SAN20WOK2-10 179



OS-REN20WKW1-10 180



OS-REN20WKW2-10 180



OS-SAKES111-10 181



OS-SAKES111KW-10 181



OP-PIREN1 182



OP-PIREN2 182

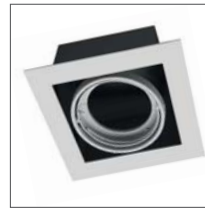

OP-PIREO1 183



OP-PIREO2 183



OS-CAM40WG9KW 184



OS-CAM40WG9KW 184



OP-PAST1 187



OP-PAST2 188



OP-PADST1 189



OP-PADRK1 190



OP-PROD3 191



OP-PROD4 192



OP-PRAN5 193



OP-PRAN6 194





























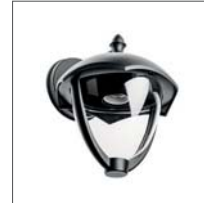













OP-OPROKR 195



OP-OPRKWT 195

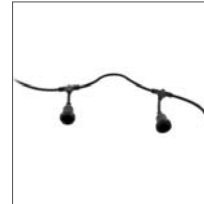

OP-OPRKW1 196

					
OP-OPROK1 196	OP-SALKW 197	OP-SALOK 197	OP-PALACEDOK 198	OP-PALACEDKW 198	OP-PALACEOK 199
					
OP-PALACEKW 199	OP-ALSOK-10 200	OP-ALSKW-10 200	OP-AUROKB 201	OP-AURKWB 201	LD-ESOA084 202
					
LD-ESOB084 202	LD-ESKA084 203	LD-ESKB084 203	OS-MILA00A 205	OS-MILA10P 205	OS-GRA0DA 206
					
OS-GRA0UA 206	OS-GRA00P 207	OS-TOS0DA 208	OS-ASTRITE27 208	OS-MARINADA-00 210	OS-MARINAUA-00 210
					
OS-MARINAP-00 211	OS-MARINAP3-00 211	OS-TMG30CM-00 211	OS-MARINAH-00 212	OS-VENTANAH-00 212	LD-VALLA8W-40 214
					
LD-PAR10W40-00 214	LD-NESSAGU10J 216	LD-NESSAGU10D 216	LD-SILVAGU10J 217	LD-SILVAGU10D 217	LD-TIAGOGU10J 218
					
LD-TIAGOGU10J 218	LD-TIAGOGU10J 220	LD-TIAGOGU10D 220	LD-BA2E27 221	LD-BALGU10 221	AE-GR610-10 222



OS-DIEGOGU10 224



OS-MARMO25-00 224



ON-ALFAOGU10 226



ON-ALFAOGU10 MINI 226



ON-ALFAO 227



LB-GAL3WRU 229



LB-GAL5WRU 229



LB-GAL5WMO 230



LP-BENFICA2 230



Systemy szynowe
Track systems
Трековые системы освещения
Трекові системи освітлення



XLD-Z3OP20SZ1-00 236



ZLD-30W1538ZLN 237



TLD-12W38LN-NBO 237



XLD-1524XLN-CBO 238



XLD-1524XLN-CB1 239



XTR-RA3FZ1B 241



XAE-ZKUNCB 241



XAE-KZASLB 241



XAE-KZASPB 242



XAE-LKLRZWB 242



XAE-LKLPWB 242



XAE-LKLLZB 243



XAE-LKTZPB 243



XAE-LKTZLB 243



XAE-LKTWPB 244



XAE-LKTWLB 244



XAE-LKXUB 244



XAE-LKTRZWPB 245

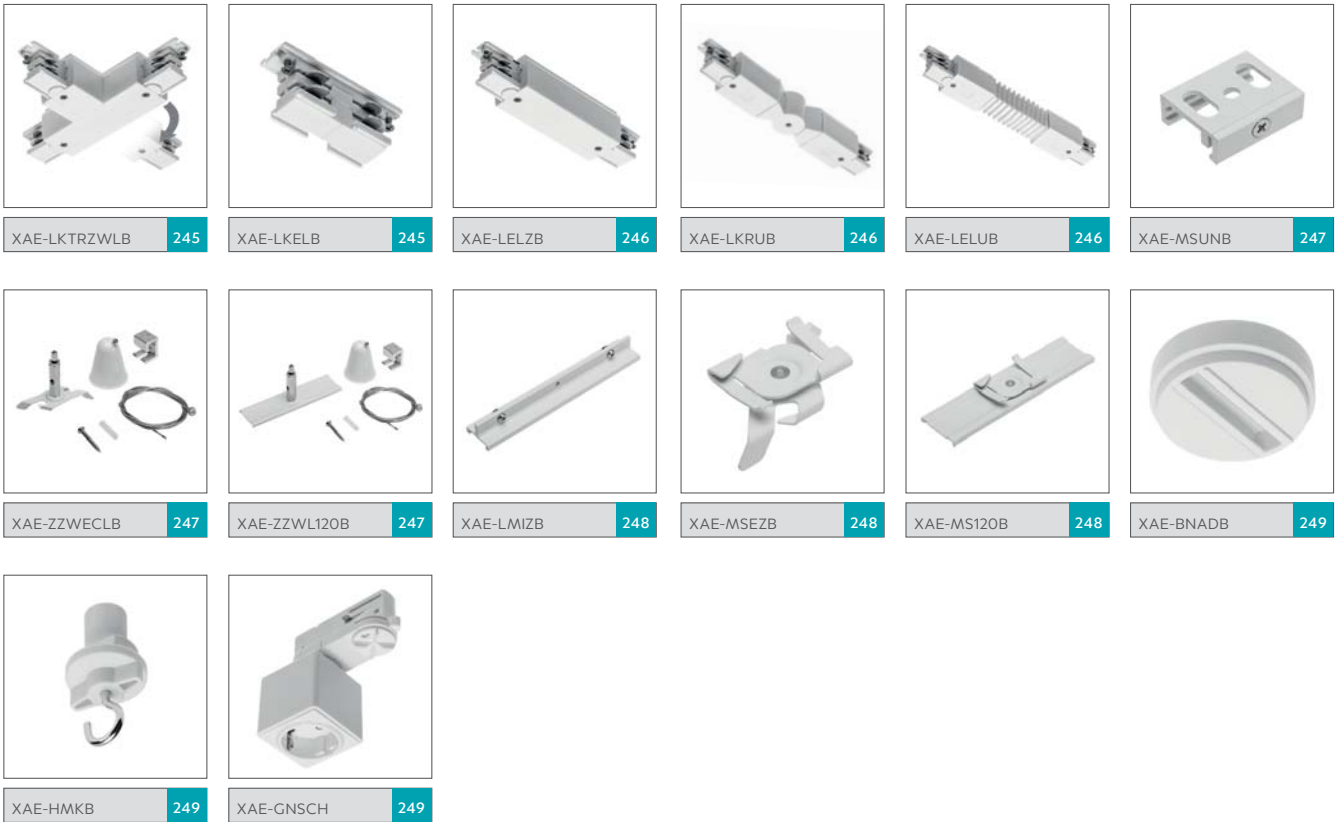

Osprzęt elektroinstalacyjny
Installation fittings
Электроустановочные изделия
Електромонтажні вироби





CR-CO1000 264



CR-CR1100 264



CR-CR13000 265



CR-CR1400-00 265



CR-CR15000 266



CR-CR16000 266



CR-CR17000-00 267



CR-CR18000-00 267



CR-CR19000-00 268



AE-CM1000 268



AE-CM3000 269



AE-CM3M00 269



AE-CM4000 270



AE-CM5000 270



AE-CM9000 271



AE-CM1500 271



AE-SRC812-MIN 272



AE-SRC812-MIN2 272



AE-SRC812 273



CZ-CZ1000 273



CZ-CZ2000 274



AE-GSF2USB-10 274



PC-MECH24 275



PC-ELE724 275



AE-PS3G3M 276



AE-PF3G1M 276



AE-SBEBEN 277



AE-PFBEBEN 277



AE-POGRODUN 278



GZ-GZ10 278

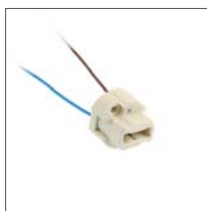

GZ-G90000 279



AE-RU012 279



AE-RU0102 279



AE-SC0102 280



AE-SC0103 280



AE-VA1UNI 280



AE-RU0103 281



AE-OCEF27 281



AE-OCEE14 281



AE-OCEE27 282



AE-OCHT27 282



AE-OPE27K 282



AE-OPE27P 283



GZ-E27000 283



AE-E14GU10 283



AE-E14E27 284



AE-E27E14 284



AE-27GU10 284



AE-GU10E27 285



AE-E40E27 285



AE-E27RING 285



WZL-2 286



WZL-3 286



WZL-4 286



LZ-KOI2KO 287



LZ-25MM00 287



AE-MA8025-10 288



AE-MAS80X80-10 288



AE-CANOPY 289



OH-ST2500 289



LD-KABE2M 290



KB-W310HUG 290



OS-STA422 290



OS-SEL236 291



OS-NSEL258-00 291



BK-PUL030A-0700AD 292



BK-BHL050-1000BZ 292



OA-MALEDPAN-00 293





















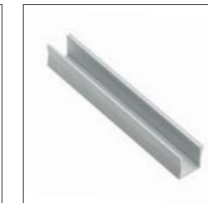























































Oświetlenie meblowe / Profile LED

Furniture lighting / LED profiles

Освещение мебели / Профили для светодиодных лент

Освітлення меблів / Профіль для світлодіодної стрічки

					
LD-3528-300-20 298	LD-3528-300-20 300	LD-3528-300-20-CB 300	PA-GLAXGKL3M 301	PA-GLAXGKS3M 301	PA-GLAXGKW3M 302
					
PA-GLAXGKW3M 302	PA-GLAXGKZK3M 303	PA-GLAXMICNK 304	PA-GLAXMNK 306	PA-GLAXNK 307	PA-GLAXMNKW 308
					
PA-GLAXMIC 309	PA-GLAX 310	PA-GLAXMW 311	PA-GLAXDR 312	PA-GLAXRAD 313	PA-GLAXWN 314
					
PA-GLAXNKT 315	PA-GLAXMPK 316	PA-GLAXNBJ2M16 317	PA-GLAXNBJW3M16 317	PA-GLAXNBD3M16 318	PA-GLAXNBDW3M16 318
					
PA-GLAXMNBW3M 319	PA-GLAXMNBW3M 319	PA-GLAXKT-AL 320	PA-GLAXWPKT-AL 320	LD-VA24CB-53 323	LD-LU16CB-53 323
					
LD-KJVCB-CB 324	LD-OJVCB-CB 324	LD-PJVCB-CB 325	LD-CS36CB-53 325	LD-VE15CB-53 326	LD-VE15CBZB-53 326

					
LD-AL24CB-53 327	LD-TR24CB-53 327	LD-OPT30S-53N 328	LD-Z3CSCB-53 328	LD-Z5CSCB-53 329	LD-LCG319-53 329
					
LD-OBP27CB-53 330	LD-KWP27CB-53 330	LD-WL2457-53 331	LD-OP408C-53 331	LD-OP456C-53 332	LD-OPD5W0-CB 332
					
LD-SR16CB-53 333	LD-RA60CB-40N 333	LD-MAX60CB-40N 334	LD-AB18CB-53 334	LD-EIW09CB-CZ 335	LD-NO24CB-00 335
					
LD-FL36CB-00 336	LD-NKW18CB-40 336	LD-IRUSB-53 337	LD-CHIC16NE-10 337	LD-BOS1CBWG-53 338	LD-KLPCB-00N 338
					
LD-3SKL-CBN 339	LD-ML1000-00 339	LD-ML2000-00 340	LD-ML3000-00 340	LD-ML4000-00 341	LD-ML5000-00 341
					
LD-ZASPRO07W-30 343	LD-ZAS75W-30 344	LD-ZAS24PRO80W 344	LD-ZZAS07PROKD6 345	LD-SZAHQ06W-MA 345	LD-ZAS150-NW 346
					
LD-ZAS350-NW 346	LD-WZA20W-NW 347	LD-ZASPU15W-30N 347	LD-ZSKL15-00N 348	LD-ZWND6W-10 348	TE-600000-30 349



LD-KONMINI-RGB 349



LD-ZAC6WDE-RGB 350



LD-ZL5RGB150-00 350



LD-KONML-MONO 351



LD-KONML-RGBW 351



LD-KONML-WIFI 352



LD-KONML-MONO-PIL 352



LD-KONML-RGBW-PIL 353



LD-KONML-MONO-PAN 353



LD-KONML-WRGB-PAN 354



LD-KONML-AD 354



AE-WDBP1-10 355



AE-WDBP2CCT-10 355



AE-WBEZDC-10S 356



AE-WBEZDK15-10 356



AE-WBEZDPIR-10 357



AE-WBEZDPIR2-20 357



AE-WBBUNI-10DIM 358



AE-WDSB-10DIM 358



AE-WBEZD-NB 359



AE-WPDRW-00 359



AE-WLPR-60 360



AE-WLB01-10 360



AE-WLIP44-15 361



AE-WLKON-20 361



LD-DIMLED-10 362



AE-WLLAN1-10 362



AE-WLSZN1-10 363



LD-KABE2M-00 363



LZ-KAPR2M-10 364



LZ-AKZ312-10N 364



LZ-AKZ612-10N 365



LD-ZTL8MM-02N 365



LD-ZTK8MM-02N 366



LD-ZTK8MM-02N 366



LD-ZTL82M-2N 367



LD-ZTL8MMAMP-02N 367



LD-ZTKS8MM-02N 368



AE-ZUSB-20 368



AE-ZLADPOD-20 369



AE-ZLADLUX-40 369



AE-BPW1S2UCH-80 371



AE-BPW1U1UCH-53 371



AE-BPW1U1UCH-51 372



AE-BPW4U100-53 372



AE-BPW3GU-20 373



AE-BPW3U60-20 373



AE-PB03GS-53 374



AE-PBU2GU-10 374



AE-PB02GS-53 375



AE-PB02GSHDMI-53 375



AE-PBSC3GS-10 376



AE-PBC3GS-51BK 376



AE-PBC3GS-53BKS 377



AE-PBC2GS1HDMI-53 377



AE-PBKT4U-80 378



AE-PBKTM2S-80 378



AE-PBKTM1SW-80 379



AE-PBKTM1SCCT-80 379



AE-PBOX1SW-80 380



AE-PBMUL6U6U-53 380





ŹRÓDŁA ŚWIATŁA
LIGHT SOURCES
ИСТОЧНИКИ СВЕТА
ДЖЕРЕЛА СВІТЛА



Źródła światła LED	
Light sources	
Светодиодные источники света	
Світлодіодні джерела світла	23
Świetlówki LED typu T8	
LED light sources, T8	
Светодиодная лампа типа T8	
Світлодіодні лампи типу T8	50



ŹRÓDŁA ŚWIATŁA LED
LED LIGHT SOURCES
СВЕТОДИОДНЫЕ ИСТОЧНИКИ СВЕТА
СВІТЛОДІОДНЕ ДЖЕРЕЛО СВІТЛА

PL Źródło światła LED
 EN LED light source
 RU Светодиодный источник света
 UK Світлодіодне джерело світла

C30

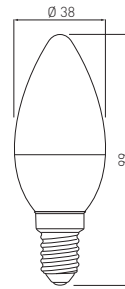

LED TECHNOLOGY

E14

3-6 W



LD-SMGC30B-30	3 W	3 W = 21 W	33 mA	● 3000 K	200 lm	PF > 0,4	32 g	5901867120014
LD-SMNGC30B-30				● 4000 K				5902801235139
LD-SMGC30B-60	6 W	6 W = 40 W	52 mA	● 3000 K	470 lm	PF > 0,5		5901867171948
LD-SMNGC30B-60				● 4000 K				5902801235344



PL Źródło światła LED
 EN LED light source
 RU Светодиодный источник света
 UK Світлодіодне джерело світла

C37

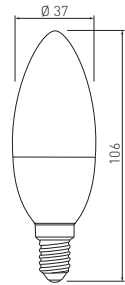

LED TECHNOLOGY

E14

8 W



LD-SMDC37-80	8 W	8 W = 54 W	70 mA	● 3000 K	700 lm	30 g	5902801028373
LD-SMND37-80				● 4000 K			5902801298967



PL Źródło światła LED
 EN LED light source
 RU Светодиодный источник света
 UK Світлодіодне джерело світла

C35

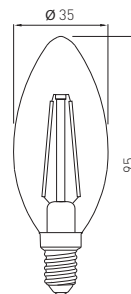

LED TECHNOLOGY

E14

4 W



LD-C35FL4M-30	4 W	4 W = 35 W	35 mA	● 3000 K	400 lm	30 g	5902801232695
---------------	-----	------------	-------	----------	--------	------	---------------



PL Źródło światła LED
EN LED light source
RU Светодиодный источник света
UK Світлодіодне джерело світла

C35

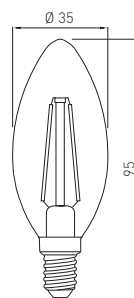

LD-C35FL4-30	4 W	4 W = 35 W	35 mA	3000 K	400 lm	13 g	5901867161512



PL Źródło światła LED
EN LED light source
RU Светодиодный источник света
UK Світлодіодне джерело світла

C30

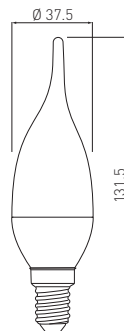

LD-SMGC30L-60	6 W	6 W = 40 W	52 mA	3000 K	470 lm	35 g	5901867120359
LD-SMNGC30L-60				4000 K			5902801235016



PL Źródło światła LED
EN LED light source
RU Светодиодный источник света
UK Світлодіодне джерело світла

C37L

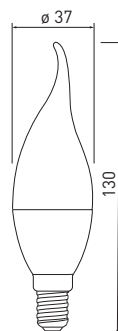

LD-SMC37L-80	8 W	8 W = 54 W	70 mA	3000 K	700 lm	30 g	5902801028380
LD-SMNC37L-80				4000 K			5902801298899



PL Źródło światła LED
 EN LED light source
 RU Светодиодный источник света
 UK Світлодіодне джерело світла

C35L

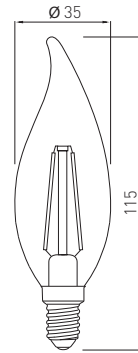

LED



E14

4 W



LD-C35FL4M-30L	4 W	4 W = 35 W	35 mA	3000 K	400 lm	30 g	5902801237294
----------------	-----	------------	-------	--------	--------	------	---------------



PL Źródło światła LED
 EN LED light source
 RU Светодиодный источник света
 UK Світлодіодне джерело світла

C35L

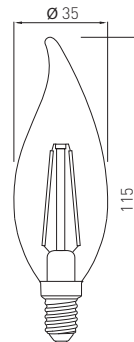

LED



E14

4 W



LD-C35FL4-30L	4 W	4 W = 35 W	35 mA	3000 K	400 lm	13 g	5901867161529
---------------	-----	------------	-------	--------	--------	------	---------------



PL Źródło światła LED
 EN LED light source
 RU Светодиодный источник света
 UK Світлодіодне джерело світла

B45

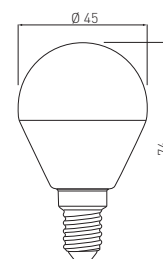

LED



E14

3-6 W



LD-SMGB45B-30	3 W	3 W = 21 W	33 mA	3000 K	200 lm	PF > 0,4	35 g	5901867120410
LD-SMNGB45B-30				4000 K				5902801235481
LD-SMGB45B-60	6 W	6 W = 40 W	52 mA	3000 K	470 lm	PF > 0,5		5901867120465
LD-SMNGB45B-60				4000 K				5902801234941





E14

8 W

PL Źródło światła LED
EN LED light source
RU Светодиодный источник света
UK Світлодіодне джерело світла

B45

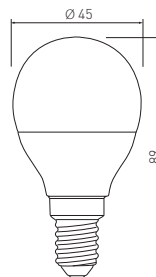

LD-SMB45B-80	8 W	8 W = 54 W	70 mA	3000 K	700 lm	30 g	5902801028397
LD-SMNB45B-80				4000 K			5902801298929



PL Źródło światła LED
EN LED light source
RU Светодиодный источник света
UK Світлодіодне джерело світла

G45

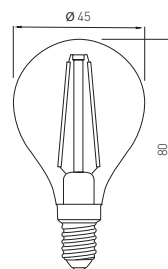

E14

4 W

LD-G45FL4M-30	4 W	4 W = 35 W	35 mA	3000 K	400 lm	30 g	5902801230172



PL Źródło światła LED
EN LED light source
RU Светодиодный источник света
UK Світлодіодне джерело світла

G45

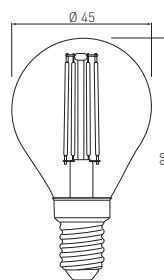

E14

4 W

LD-G45FL4-30	4 W	4 W = 35 W	35 mA	3000 K	400 lm	13 g	5901867161536

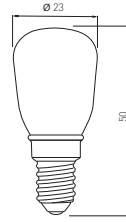

PL Źródło światła LED
 EN LED light source
 RU Светодиодный источник света
 UK Світлодіодне джерело світла

LED
TECHNOLOGY

E14

2 W



LD-E14S2W0-40	2 W	2 W = 19 W	22 mA	● 4000 K	180 lm	10 g	5901867168719
---------------	-----	------------	-------	----------	--------	------	---------------

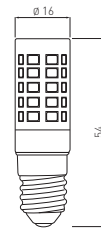

PL Źródło światła LED
 EN LED light source
 RU Светодиодный источник света
 UK Світлодіодне джерело світла

LED
TECHNOLOGY

E14

3,5 W



LD-E14P35W-30	3,5 W	3,5 W = 30 W	38 mA	● 3000 K	320 lm	12 g	5901867173621
---------------	-------	--------------	-------	----------	--------	------	---------------



PL Źródło światła LED
 EN LED light source
 RU Светодиодный источник света
 UK Світлодіодне джерело світла

R50

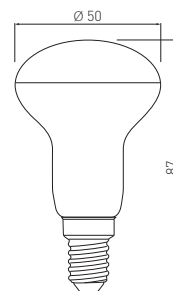
LED
TECHNOLOGY

E14

6 W



LD-R5060W-30	6 W	6 W = 40 W	52 mA	● 3000 K	470 lm	28 g	5901867113467
LD-R5060W-40		6 W = 42 W		● 4000 K	500 lm		5902801215872



PL Źródło światła LED
EN LED light source
RU Светодиодный источник света
UK Світлодіодне джерело світла

R63

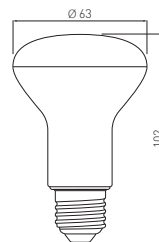

LD-R6380W-30	8 W	8 W = 51 W	70 mA	3000 K	650 lm	51 g	5901867113436
LD-R6380W-40		8 W = 53 W		4000 K	680 lm		5902801215711



PL Źródło światła LED
EN LED light source
RU Светодиодный источник света
UK Світлодіодне джерело світла

A60

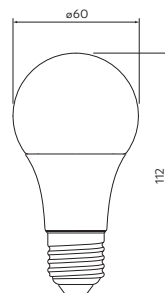

LD-A60CZ3-10W	10 W	10 W = 61 W	87 mA	3000 K	810 lm	40 g	5902801074257
LD-A60CZ4-10W				4000 K			5902801074233



PL Źródło światła LED
EN LED light source
RU Светодиодный источник света
UK Світлодіодне джерело світла

A60

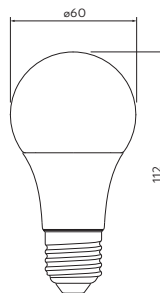

LD-A60CM3-10W	10 W	10 W = 61 W	87 mA	3000 K	810 lm	40 g	5902801073342
LD-A60CM4-10W				4000 K			5902801073335



PL Źródło światła LED
 EN LED light source
 RU Светодиодный источник света
 UK Світлодіодне джерело світла

A60



LD-PC2A60RGBW-8W	8 W	8 W = 44 W	70 mA	3000 K & RGB	540 lm	130 g	5901867155290



PL Źródło światła LED
 EN LED light source
 RU Светодиодный источник света
 UK Світлодіодне джерело світла

A60



LD-3SCTA60-10W	10 W	10 W = 62 W	87 mA	3000 K / 4000 K / 6400 K	840 lm	45 g	5902801020131



PL Źródło światła LED
 EN LED light source
 RU Светодиодный источник света
 UK Світлодіодне джерело світла

A60



LD-3SDA60-10W	10 W	10 W = 62 W	87 mA	3000 K	840 lm	50 g	5902801020148
LD-3SDA606-10W				6400 K			5902801261114



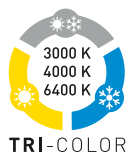

OFF



ON

OFF
<5 sek



ON

OFF
<5 sek



ON



OFF >20 sek

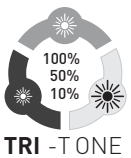

OFF



ON

OFF
<5 sek

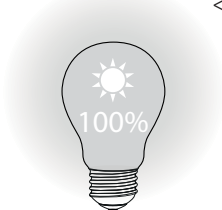

ON

OFF
<5 sek



ON



OFF >20 sek



PL Źródło światła LED
 EN LED light source
 RU Светодиодный источник света
 UK Світлодіодне джерело світла

A60

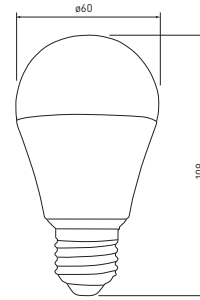
LED
 TECHNOLOGY

E27
12 W

LD-DC24A60-12	12 W	12 W = 75 W	3000 K	1055 lm	50 g	5902801270925
---------------	------	-------------	--------	---------	------	---------------



PL Źródło światła LED
 EN LED light source
 RU Светодиодный источник света
 UK Світлодіодне джерело світла

A60

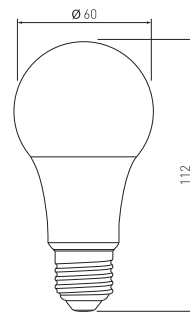

dimmable

LED
 TECHNOLOGY

E27
10 W

LD-SPCA60-10W	10 W	10 W = 61 W	87 mA	3000 K	820 lm	90 g	5902801294877
LD-SPNA60-10W				4000 K			5902801294938



PL Źródło światła LED
 EN LED light source
 RU Светодиодный источник света
 UK Світлодіодне джерело світла

A60

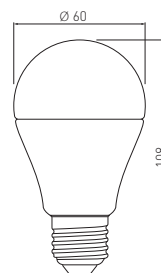
LED
 TECHNOLOGY

E27
6 W

LD-PC2A60-6W	6 W	6 W = 40 W	52 mA	3000 K	470 lm	60 g	5901867118745
--------------	-----	------------	-------	--------	--------	------	---------------



PL Źródło światła LED
EN LED light source
RU Светодиодный источник света
UK Світлодіодне джерело світла

A60

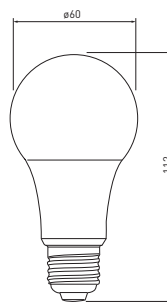

LD-PC2A60-8W	8 W	8 W = 50 W	87 mA	3000 K	640 lm	40 g	5902801216305
LD-PN2A60-8W				4000 K			5902801216312



PL Źródło światła LED
EN LED light source
RU Светодиодный источник света
UK Світлодіодне джерело світла

A60

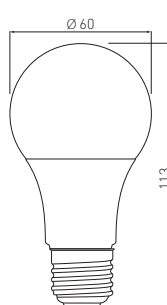

LD-PC3A60-10W	10 W	10 W = 62 W	87 mA	3000 K	840 lm	40 g	5901867153302
LD-PN3A60-10W				4000 K			5902801000508
LD-PZ3A60-10W				6400 K			5902801269639



PL Źródło światła LED
EN LED light source
RU Светодиодный источник света
UK Світлодіодне джерело світла

A60

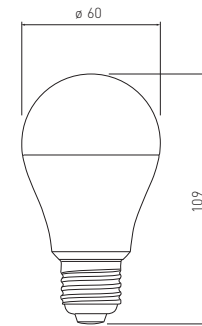

LD-PC2A60-12	12 W	12 W = 78 W	104 mA	3000 K	1100 lm	90 g	5901867131621
LD-PN2A60-12				4000 K			5902801000539
LD-PZ2A60-12				6400 K			5902801269646



PL Źródło światła LED
 EN LED light source
 RU Светодиодный источник света
 UK Світлодіодне джерело світла

A60

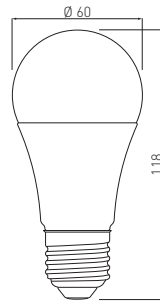

LD-PC3A60-15W	15 W	15 W = 90 W	130 mA	● 3000 K	1320 lm	140 g	5901867124838
LD-PN3A60-15W				● 4000 K			5902801000560



PL Źródło światła LED
 EN LED light source
 RU Светодиодный источник света
 UK Світлодіодне джерело світла

A60

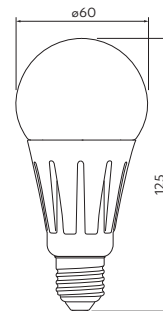

LD-AL7A60-20W	20 W	20 W = 115 W	174 mA	● 3000 K	1800 lm	157 g	5901867191212



PL Źródło światła LED
 EN LED light source
 RU Светодиодный источник света
 UK Світлодіодне джерело світла

A60

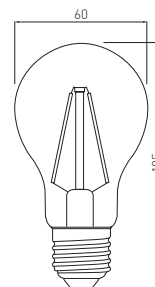

LD-A60FL8M-30	8 W	8 W = 60 W	70 mA	● 3000 K	800 lm	60 g	5902801232725



PL Źródło światła LED
EN LED light source
RU Светодиодный источник света
UK Світлодіодне джерело світла

A60

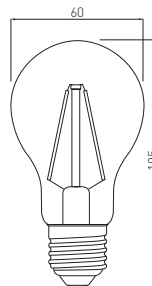

LD-A60FL8-30	8 W	8 W = 60 W	70 mA	3000 K	800 lm	34 g	5901867161505



PL Źródło światła LED

EN LED light source
RU Светодиодный источник света
UK Світлодіодне джерело світла

G95

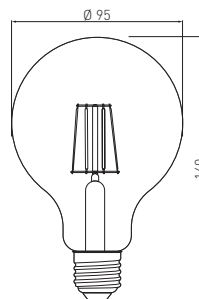

LD-G95FL8-30	8 W	8 W = 60 W	70 mA	3000 K	810 lm	100 g	5901867194466



PL Źródło światła LED

EN LED light source
RU Светодиодный источник света
UK Світлодіодне джерело світла

G125

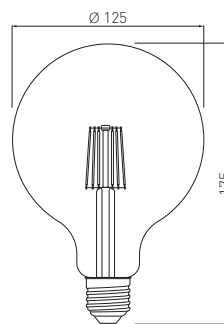

LD-G125FL8-30	8 W	8 W = 60 W	70 mA	3000 K	810 lm	200 g	5901867194473



PL Źródło światła LED
 EN LED light source
 RU Светодиодный источник света
 UK Світлодіодне джерело світла

ST64

360°

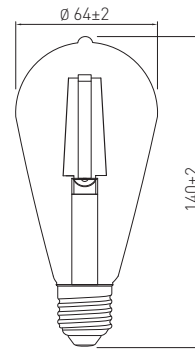
 LED
 TECHNOLOGY

E27

4 W



LD-ST64FV4-30	4 W	4 W = 36 W	43 mA	3000 K	400 lm	46 g	5902801256608
---------------	-----	------------	-------	--------	--------	------	---------------



PL Źródło światła LED
 EN LED light source
 RU Светодиодный источник света
 UK Світлодіодне джерело світла

G95

360°

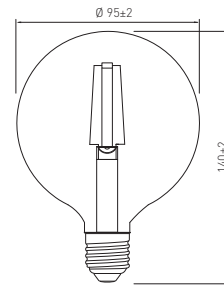
 LED
 TECHNOLOGY

E27

4 W



LD-G95FV4-30	4 W	4 W = 36 W	43 mA	3000 K	400 lm	56 g	5902801256776
--------------	-----	------------	-------	--------	--------	------	---------------



PL Źródło światła LED
 EN LED light source
 RU Светодиодный источник света
 UK Світлодіодне джерело світла

G125

360°

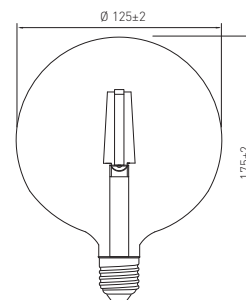
 LED
 TECHNOLOGY

E27

4 W



LD-G125FV4-30	4 W	4 W = 36 W	43 mA	3000 K	400 lm	100 g	5902801257292
---------------	-----	------------	-------	--------	--------	-------	---------------





PL Źródło światła LED
EN LED light source
RU Светодиодный источник света
UK Світлодіодне джерело світла

G120

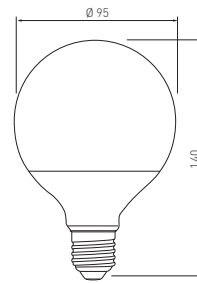

LED



E27

14-18 W



LD-120G14W-32	14 W	14 W = 86 W	122 mA	● 3000 K	1250 lm	107 g	5901867169242
LD-120G14W-40				● 4000 K			5902801299230
LD-120G18W-32	18 W	18 W = 105 W	157 mA	● 3000 K	1600 lm	155 g	5901867169259
LD-120G18W-40				● 4000 K			5902801299278



PL Źródło światła LED
EN LED light source
RU Светодиодный источник света
UK Світлодіодне джерело світла

G45



LED



E27

2-4 W



LD-G45FL2E-30	2 W	2 W = 20 W	22 mA	● 3000 K	200 lm	13 g	5902801284199
LD-G45FL4E-30	4 W	4 W = 35 W	35 mA		400 lm		5902801284267



PL Źródło światła LED
EN LED light source
RU Светодиодный источник света
UK Світлодіодне джерело світла

C30

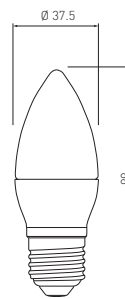

LED



E27

6 W



LD-SMGC30C-60	6 W	6 W = 40 W	52 mA	● 3000 K	470 lm	35 g	5901867120175
LD-SMNGC30C-60				● 4000 K			5902801235061





E27

6 W



PL Źródło światła LED
EN LED light source
RU Светодиодный источник света
UK Світлодіодне джерело світла

B45

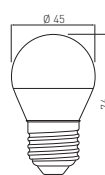

LD-SMGB45C-60	6 W	6 W = 40 W	52 mA	3000 K	470 lm	37 g	5901867120519
LD-SMNGB45C-60				4000 K			5902801235030



PL Źródło światła LED
EN LED light source
RU Светодиодный источник света
UK Світлодіодне джерело світла

B45

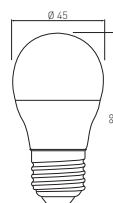

E27

8 W

LD-SMBD45-80	8 W	8 W = 54 W	70 mA	3000 K	700 lm	30 g	5902801028403
LD-SMNBD45-80				4000 K			5902801298868



PL Źródło światła LED
EN LED light source
RU Светодиодный источник света
UK Світлодіодне джерело світла

UFO

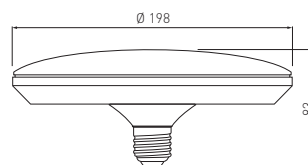

E27

18 W

LD-UFO18W-30	18 W	18 W = 94 W	157 mA	3000 K	1400 lm	240 g	5902801001710
LD-UFO18W-40				4000 K			5902801299285



PL Źródło światła LED do lamp ulicznych
 EN LED light source, for street lamps
 RU Светодиодный источник света, для уличных фонарей
 UK Джерело світла LED для вуличних ліхтарів



E27

30-40 W

F100, F120

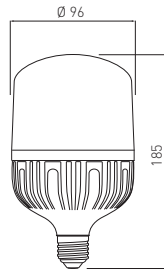

LD-ALF100-30W

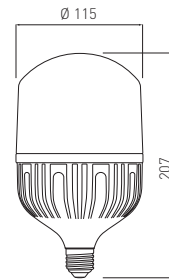

LD-ALF120-40W

Folder	W	mA	Color	Light	Weight	Barcode
LD-ALF100-30W	30 W	145 mA	● 4000 K	2700 lm	196 g	5901867191199
LD-ALF120-40W	40 W	193 mA		3600 lm	285 g	5901867191205



PL Źródło światła LED do lamp ulicznych
 EN LED light source, for street lamps
 RU Светодиодный источник света, для уличных фонарей
 UK Джерело світла LED для вуличних ліхтарів

F140



E40

50 W

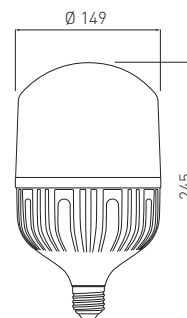

Folder	W	mA	Color	Light	Weight	Barcode
LD-ALF140-50W	50 W	242 mA	● 4000 K	4500 lm	440 g	5902801010736



PL Źródło światła LED
EN LED light source
RU Светодиодный источник света
UK Світлодіодне джерело світла

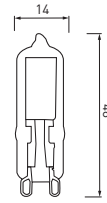

LD-G93W25-30	3 W	3 W = 25 W	33 mA	● 3000 K	250 lm	5 g	5902801211058
LD-G93W25-40				● 4000 K			5902801203343



PL Źródło światła LED
EN LED light source
RU Светодиодный источник света
UK Світлодіодне джерело світла

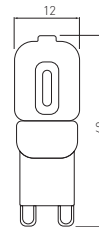

LD-G93W24-32	3 W	3 W = 25 W	33 mA	● 3000 K	240 lm	40 g	5901867150684
LD-G93W24-45				● 4000 K			5901867150714



PL Źródło światła LED
EN LED light source
RU Светодиодный источник света
UK Світлодіодне джерело світла

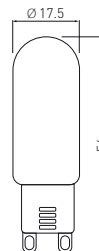

LD-G96440-32	4 W	4 W = 29 W	43 mA	● 3000 K	300 lm	20 g	5901867141606
LD-G96440-45				● 4000 K	320 lm		5901867141620

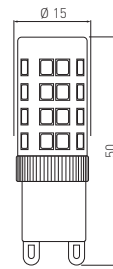

PL Źródło światła LED
 EN LED light source
 RU Светодиодный источник света
 UK Світлодіодне джерело світла

LED
TECHNOLOGY

G9

3,5 W



LD-G9P35W-30	3,5 W	3,5 W = 30 W	38 mA	● 3000 K	320 lm	12 g	5901867168726
LD-G9P35W-40				● 4000 K			5901867168733

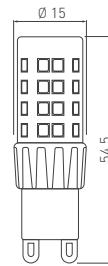

PL Źródło światła LED
 EN LED light source
 RU Светодиодный источник света
 UK Світлодіодне джерело світла

LED
TECHNOLOGY

G9

5 W



LD-G9P5W0-30	5 W	5 W = 37 W	43 mA	● 3000 K	420 lm	14 g	5901867168740
LD-G9P5W0-40				● 4000 K			5901867168757



PL Źródło światła LED
 EN LED light source
 RU Светодиодный источник света
 UK Світлодіодне джерело світла

360°

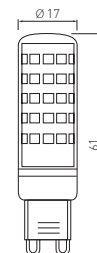
LED
TECHNOLOGY

G9

7 W



LD-G9P7W0-30	7 W	7 W = 45 W	61 mA	● 3000 K	560 lm	18 g	5902801011344
LD-G9P7W0-40				● 4000 K			5902801011375



PL Źródło światła LED
EN LED light source
RU Светодиодный источник света
UK Світлодіодне джерело світла

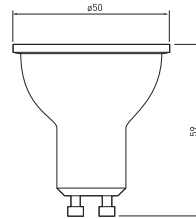

LD-SPCGU10-7W	7 W	7 W = 45 W	61 mA	3000 K	560 lm	70 g	5902801295010
LD-SPNGU10-7W				4000 K			5902801295010



PL Źródło światła LED
EN LED light source
RU Светодиодный источник света
UK Світлодіодне джерело світла

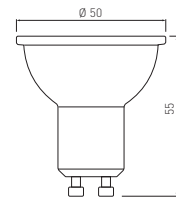

LD-NGU10PN-1W*	1 W	-	14 mA	4000 K	100 lm	90°	37 g	5901867194954
LD-NGU10P-3W	3 W	3 W = 23 W	33 mA	3000 K	220 lm	120°	20 g	5901867131591
LD-NGU10PN-3W				4000 K				
LD-NGU10P-4W	4 W	4 W = 29 W	43 mA	3000 K	300 lm	PF > 0,4	20 g	5908231395702
LD-NGU10PN-4W				4000 K				



PL Źródło światła LED
EN LED light source
RU Светодиодный источник света
UK Світлодіодне джерело світла

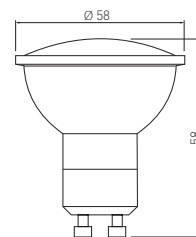

LD-SZ1510-30	4 W	4 W = 30 W	43 mA	3000 K	320 lm	45 g	5901867109712
LD-SZ1510-40		4 W = 31 W		4000 K	330 lm		5901867109729
LD-SZ1510-64		4 W = 31 W		6400 K	340 lm		5901867109743

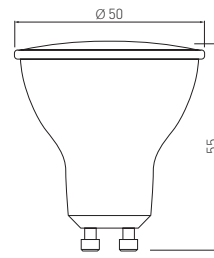

PL Źródło światła LED
 EN LED light source
 RU Светодиодный источник света
 UK Світлодіодне джерело світла

 3 years
 warranty

LED

GU10

5 W

Folder	W	LED	mA	Color	lm	g	Barcode
LD-SZ5010-30	5 W	5 W = 36 W	43 mA	3000 K	400 lm	45 g	5901867196798
LD-SZ5010-40				4000 K			5902801000690
LD-SZ5010-64				6400 K			5901867196804



PL Źródło światła LED
 EN LED light source
 RU Светодиодный источник света
 UK Світлодіодне джерело світла

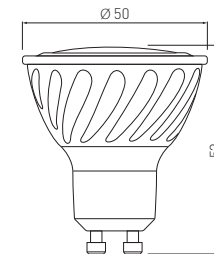

LED

GU10

6 W

Folder	W	LED	mA	Color	lm	g	Barcode
LD-PC6010-30	6 W	6 W = 38 W	52 mA	3000 K	440 lm	52 g	5901867155436
LD-PC6010-40				4000 K			5901867198785
LD-PC6010-64				6400 K			5901867197139



PL Źródło światła LED
 EN LED light source
 RU Светодиодный источник света
 UK Світлодіодне джерело світла

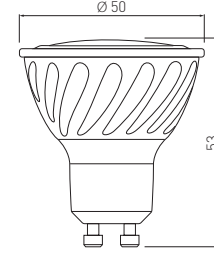

LED

GU10

7,5 W

Folder	W	LED	mA	Color	lm	g	Barcode
LD-PC7510-30	7,5 W	7,5 W = 46 W	65 mA	3000 K	570 lm	52 g	5901867155405
LD-PC7510-40				4000 K			5901867198792
LD-PC7510-64				6400 K			5901867197160



PL Źródło światła LED
EN LED light source
RU Светодиодный источник света
UK Світлодіодне джерело світла



LD-SM1210-10	10 W	10 W = 55 W	87 mA	● 3000 K	720 lm	50 g	5901867189967
LD-SM1210N-10				● 4000 K			5902801299513



PL Źródło światła LED
EN LED light source
RU Светодиодный источник света
UK Світлодіодне джерело світла

J78

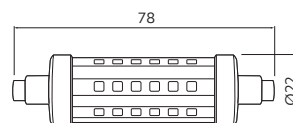

LD-J7806W-40	6 W	6 W = 48 W	52 mA	● 4000 K	600 lm	240 g	5902801007743



PL Źródło światła LED
EN LED light source
RU Светодиодный источник света
UK Світлодіодне джерело світла

J118

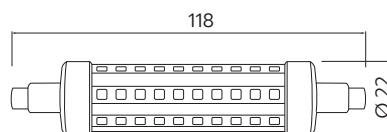

LD-J11810W-40	10 W	10 W = 65 W	87 mA	● 4000 K	900 lm	390 g	5902801007750



PL Źródło światła z diodami POWER LED
 EN POWER LED light source
 RU Источник света со светодиодами POWER LED
 UK Світлодіодний джерело світла зі світлодіодами POWER



LD-ES11100-30



LD-ES11101-30

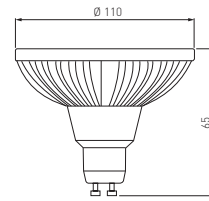

LED

GU10

12 W



LD-ES11100-30*	12 W	12 W = 69 W	104 mA	● 3000 K	950 lm	45°	czarny, black, черный, чорний	160 g	5901867128119
LD-ES11101-30		12 W = 63 W			850 lm	120°			5901867128113
LD-ES11101-40		12 W = 69 W		● 4000 K	850 lm	120°			5901867196217



PL Źródło światła z diodami POWER LED
 EN POWER LED light source
 RU Источник света со светодиодами POWER LED
 UK Світлодіодний джерело світла зі світлодіодами POWER



LD-ES11177-30



LD-ES11175-30

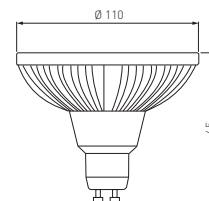

LED

GU10

12 W



LD-ES11177-30*	12 W	12 W = 69 W	104 mA	● 3000 K	950 lm	45°	szary, grey, серый, grau	160 g	5901867127242
LD-ES11175-30		12 W = 63 W			850 lm	120°			5901867127228
LD-ES11175-40				● 4000 K	850 lm	120°			5901867196194



PL Źródło światła z diodami POWER LED
 EN POWER LED light source
 RU Источник света со светодиодами POWER LED
 UK Світлодіодний джерело світла зі світлодіодами POWER



LD-ES11110-30



LD-ES11115-30

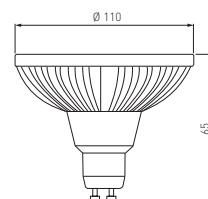

LED

GU10

12 W



LD-ES11110-30*	12 W	12 W = 69 W	104 mA	● 3000 K	950 lm	45°	biały, white, белый, білий,	160 g	5901867128157
LD-ES11115-30		12 W = 63 W			850 lm	120°			5901867128171
LD-ES11115-40		12 W = 69 W		● 4000 K	850 lm	120°			5901867196200



PL Źródło światła z diodami POWER LED
 EN POWER LED light source
 RU Источник света со светодиодами POWER LED
 UK Світлодіодний джерело світла зі світлодіодами POWER



LD-AR11120-30



LD-AR11145-30

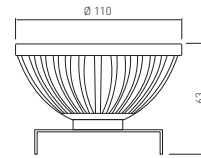

LD-AR11120-30	12 W	12 W = 63 W	3000 K	850 lm	120°	160 g	5901867109446
LD-AR11145-30*		12 W = 69 W		950 lm	45°		5901867109408



PL Źródło światła LED
 EN LED light source
 RU Светодиодный источник света
 UK Світлодіодне джерело світла

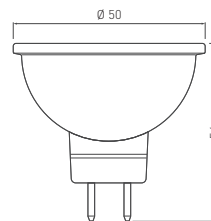

LD-SM4016-30	4 W	4 W = 35 W	3000 K	300 lm	30 g	5901867190079
LD-SM4016-64			6400 K			5901867190109



PL Źródło światła LED
 EN LED light source
 RU Светодиодный источник света
 UK Світлодіодне джерело світла

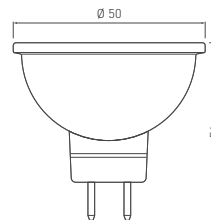

LD-SM6016-30	6 W	6 W = 37 W	3000 K	420 lm	30 g	5901867190048
--------------	-----	------------	--------	--------	------	---------------



PL Źródło światła LED
 EN LED light source
 RU Светодиодный источник света
 UK Світлодіодне джерело світла

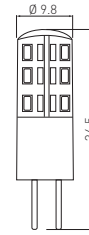

LD-G4S115-32	2 W	2 W = 13 W	3000 K	140 lm	3 g	5901867106322
LD-G4S115-45			4000 K			5901867115966



PL Źródło światła LED
 EN LED light source
 RU Светодиодный источник света
 UK Світлодіодне джерело світла

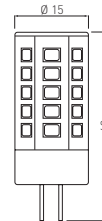

LD-G4P35W-30	3,5 W	3,5 W = 30 W	3000 K	320 lm	11 g	5901867168764
LD-G4P35W-40			4000 K			5901867168771



PL Źródło światła LED
 EN LED light source
 RU Светодиодный источник света
 UK Світлодіодне джерело світла

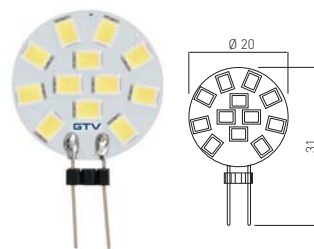

LD-G4015W-30

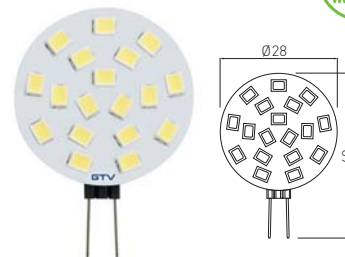

LD-G4020W-30



LD-G4015W-30	1,5 W	1,5 W = 17 W	3000 K	160 lm	1,7 g	5901867191182
LD-G4020W-30	2 W	2 W = 23 W		220 lm	2,9 g	5901867191250







ŚWIETLÓWKI LED TYPU T8
LED LIGHT SOURCES T8
СВЕТОДИОДНЫЕ ЛАМПЫ ТИПА Т8
СВІТЛОДІОДНІ ЛАМПЫ ТИПУ Т8

PL Źródło światła LED, T8
EN LED light source, T8
RU Светодиодная лампа типа T8
UK Світлодіодна лампа типу T8

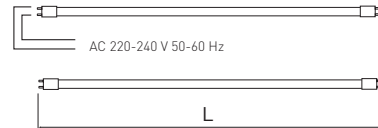

SW-NPC09WNB-60PR	9 W	78 mA	● 4000 K	900 lm	600 mm	5902801006944
SW-NPC18WNB-120PR	18 W	157 mA		1800 lm	1200 mm	5902801006951



PL Źródło światła LED, T8
EN LED light source, T8
RU Светодиодная лампа типа T8
UK Світлодіодна лампа типу T8

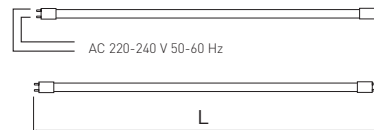

SW-NSZT810W-60	10 W	87 mA	● 4000 K	1000 lm	600 mm	5902801204777
SW-ZSZT810W-60			● 6400 K			5902801204876
SW-NSZT819W-120	19 W	165 mA	● 4000 K	1900 lm	1200 mm	5902801204708
SW-ZSZT819W-120			● 6400 K			5902801204623
SW-NSZT824W-150	24 W	209 mA	● 4000 K	2400 lm	1500 mm	5902801204746
SW-ZSZT824W-150			● 6400 K			5902801204968



PL Źródło światła LED, T8
 EN LED light source, T8
 RU Светодиодная лампа типа T8
 UK Світлодіодна лампа типу T8



LED



G13

9-24 W

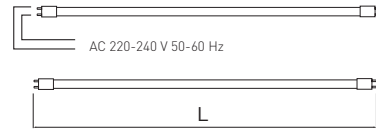

SW-HLSZT809W-60	9 W	78 mA	● 4000 K	1050 lm	600 mm	5902801241444
SW-HLSZT818W-120	18 W	157 mA		2150 lm	1200 mm	5902801241451
SW-HLSZT824W-150	24 W	209 mA		2850 lm	1500 mm	5902801241871









OPRAWY TECHNICZNE I PRZEMYSŁOWE
TECHNICAL AND INDUSTRIAL FIXTURES
ТЕХНИЧЕСКИЕ И ПРОМЫШЛЕННЫЕ СВЕТИЛЬНИКИ
ТЕХНІЧНІ ТА ПРОМИСЛОВІ СВЕТИЛЬНИКИ



Panele i oprawy LED LED panels and fixtures Светодиодные панели Світлодіодні панелі	57
Оправы промышленные LED LED industrial fixtures Промышленные светильники Світлодіодні промислові світильники	68
Plafoniere i oprawy kanałowe Ceiling and bulkhead fixtures Светодиодные светильники и светильники ЖКХ Світлодіодні світильники та світильники ЖКГ	78
Оправы LED typu downlight LED downlights Светильники типа downlight Світильники типу downlight	96
Naświetlacze LED LED Floodlights Светодиодные прожекторы Світлодіодні прожекторы	114
Оправы LED typu high bay High bay LED luminaires Светодиодные High bay светильники Світлодіодні high bay світильники	120
Оправы уличные и парковые LED Street and park LED luminaires Светодиодные уличные и парковые светильники Світлодіодні вуличні та паркові світильники	124
Оправы аварийные LED Emergency light fixtures Аварийные светильники Аварійні світильники	128
Оправы растровые, кюшзовые Louvre fixtures Растровые светильники Растрові світильники	132
Оправы промышленные Industrial fixtures Промышленные светильники Промислові світильники	136
Plafoniere i oprawy kanałowe Ceiling and bulkhead fixtures Потолочные светильники и светильники ЖКХ Стельові світильники та світильники ЖКГ	140
Оправы мастерские и лампы LED Workshop fixtures & LED flashlights світильники для мастерской и LED-фонари Світильники для майстерень та світлодіодні ліхтарики	148



PANELE I OPRAWY LED
LED PANELS AND FIXTURES
СВЕТОДИОДНЫЕ ПАНЕЛИ
СВІТЛОДІОДНІ ПАНЕЛІ

PL Ramka LED
EN LED frame
RU Светодиодная рамка
UK Світлодіодна рамка



AKORDITA

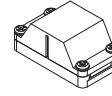
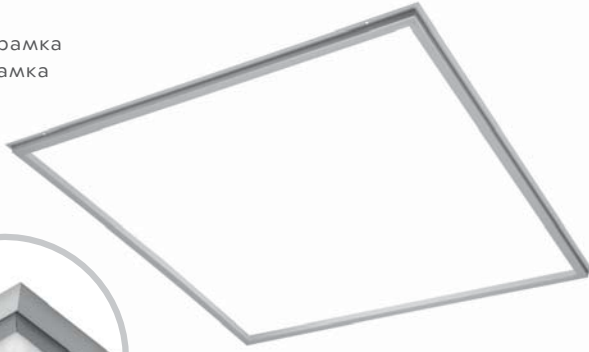

Aksesoria,
Accessories,
Аксессуары,
Аксесуари:
LZ-KO12KO-10

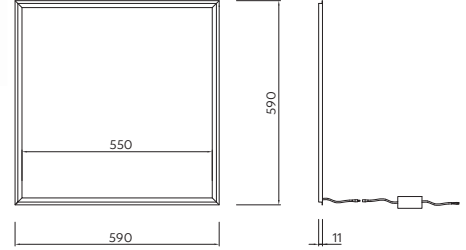

LD-AKO4060-NB	40 W	● 4000 K	3600 lm	aluminium, aluminium, алюминий, алюміній.	biały, white, белый, білий.	500 g	5902801039966
---------------	------	----------	---------	--	--------------------------------------	-------	---------------



PL Panel LED
EN LED Panel
RU Светодиодная панель
UK Світлодіодна панель



TIGER

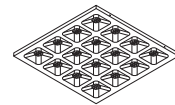
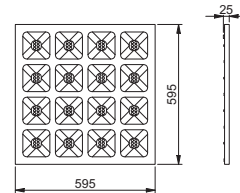

LD-TIG34W60-NB	36 W	● 4000 K	4800 lm	biały, white, белый, білий.	2850 g	5902801205453
----------------	------	----------	---------	-----------------------------	--------	---------------



PL Panel LED
EN LED Panel
RU Светодиодная панель
UK Світлодіодна панель

LION

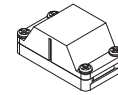

Aksesoria,
Accessories,
Аксессуары,
Аксессуары:
LZ-KOI2KO-10

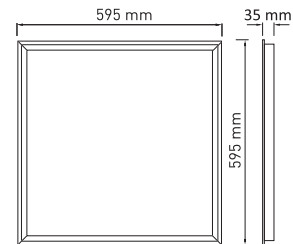

LED
TECHNOLOGY...



36 W



LD-LN36W60-NB	36 W	● 4000 K	3600 lm	metal + tworzywo, metal + plastic, металл + пластик, метал + пластик.	biały, white, белый, білий.	1720 g	5902801298639
---------------	------	----------	---------	--	-----------------------------	--------	---------------

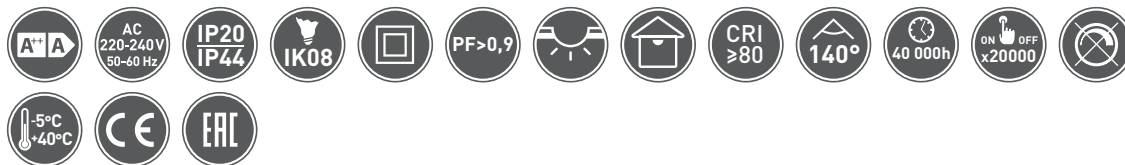

PL Panel LED
EN LED Panel
RU Светодиодная панель
UK Світлодіодна панель

LION UGR

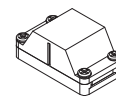

Aksesoria,
Accessories,
Аксессуары,
Аксессуары:
LZ-KOI2KO-10

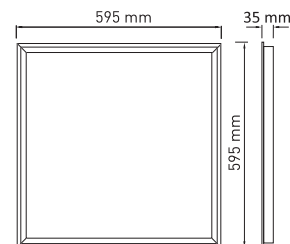

LED
TECHNOLOGY...



40 W



LD-LN40W60UGR-NB	40 W	● 4000 K	3400 lm	metal + tworzywo, metal + plastic, металл + пластик, метал + пластик.	biały, white, белый, білий.	1720 g	5902801241550
------------------	------	----------	---------	--	-----------------------------	--------	---------------



Technical & industrial
fixtures



PL Panel LED
EN LED Panel
RU Светодиодная панель
UK Світлодіодна панель

GALAXY

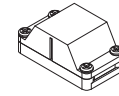

Aksesoria,
Accessories,
Аксессуары,
Аксесуари:
LZ-KOI2KO-10

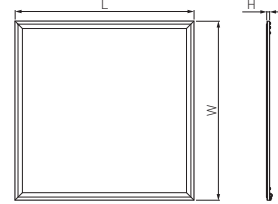

LD-GL40060-NB	40 W	● 4000 K	4400 lm	aluminium, aluminium, алюминий, алюміній.	595 x 595 x 10	biały, white, белый, білий.	2700 g	5901867195180
LD-GL40060-NBS					szary, grey, серый, сірий.	5901867195166		
LD-GL40120-NB					1195 x 295 x 10	biały, white, белый, білий.		5901867195357
LD-GL40120-NBS					szary, grey, серый, сірий.	5901867195203		



PL Panel LED
EN LED Panel
RU Светодиодная панель
UK Світлодіодна панель

GALAXY UGR

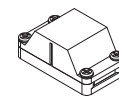

Aksesoria,
Accessories,
Аксессуары,
Аксесуари:
LZ-KOI2KO-10

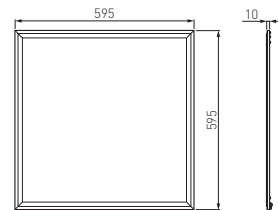

LD-GL40060UGR-NB	40 W	● 4000 K	4400 lm	aluminium, aluminium, алюминий, алюміній.	595 x 595 x 10	biały, white, белый, білий.	2700 g	5901867195456
LD-GL40060UGR-NBS					szary, grey, серый, сірий.	5901867195470		





PL Panel LED
EN LED Panel
RU Светодиодная панель
UK Світлодіодна панель

KING

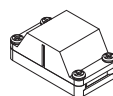

Aksesoria,
Accessories,
Аксесуары,
Аксесуари:
LZ-KO12KO-10



LD-KNG24063-NB	24 W	● 4000 K	1800 lm	aluminium, aluminium, алюминий, алюміній.	595 × 295 × 10	biały, white, белый, білий.	1500 g	5901867179746
LD-KNG24063-CB		● 3000 K			5902801261398			
LD-KNG42060-NB	42 W	● 4000 K	3200 lm		595 × 595 × 10		2700 g	5901867168542
LD-KNG42060-CB		● 3000 K			5902801261343			
LD-KNG42312-NB		● 4000 K			1195 × 295 × 10			5901867179760
LD-KNG42312-CB		● 3000 K			5902801261374			



PL Panel LED
EN LED Panel
RU Светодиодная панель
UK Світлодіодна панель

KING+

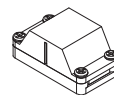

Aksesoria,
Accessories,
Аксесуары,
Аксесуари:
LZ-KO12KO-10

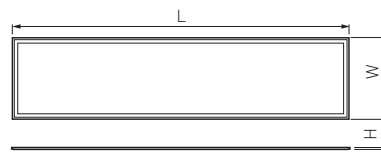

LD-KNG45060-NB	45 W	● 4000 K	4500 lm	aluminium, aluminium, алюминий, алюміній.	595 × 595 × 10	biały, white, белый, білий.	2780 g	5902801270307
LD-KNG45312-NB					1195 × 295 × 10		2680 g	5902801270567





PL Panel LED
EN LED Panel
RU Светодиодная панель
UK Світлодіодна панель

ELZA

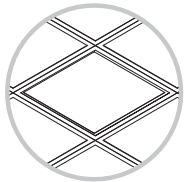

625x625 mm

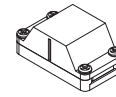

Aksesoria,
Accessories,
Аксессуары,
Аксесуари:
LZ-KO12KO-10

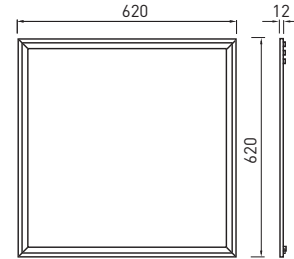

LD-DE40062-NB	40 W	● 4000 K	4400 lm	aluminium, aluminium, алюминий, алюміній.	biały, white, белый, білий.	3000 g	5902801125379
---------------	------	----------	---------	--	--------------------------------------	--------	---------------



PL Panel LED
EN LED Panel
RU Светодиодная панель
UK Світлодіодна панель

ELZA UGR

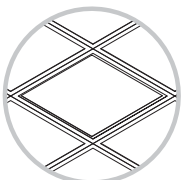

625x625 mm

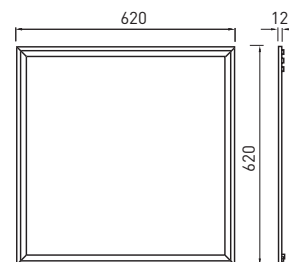

40 W



LD-DE40062UGR-NB	40 W	● 4000 K	4400 lm	aluminium, aluminium, алюминий, алюміній.	biały, white, белый, білий.	3000 g	5902801298905
------------------	------	----------	---------	--	--------------------------------------	--------	---------------



PL Panel LED
EN LED Panel
RU Светодиодная панель
UK Світлодіодна панель

VERONA

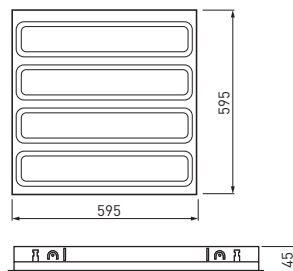

LD-VE4060W-50	50 W	● 4000 K	5500 lm	blacha stalowa, steel sheet, стальной лист, сталевий лист.	575 x 575 mm	biały, white, белый, білий.	3200 g	5901867106032
---------------	------	----------	---------	---	--------------	--------------------------------------	--------	---------------



PL Panel LED
EN LED Panel
RU Светодиодная панель
UK Світлодіодна панель

VERONA

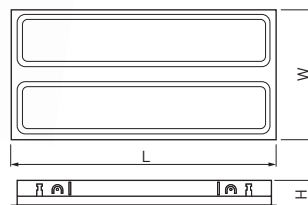

LD-VE2060N-25	25 W	● 4000 K	2750 lm	blacha stalowa, steel sheet, стальной лист, сталевий лист.	595 × 295 × 35	biały, white, белый, білий.	1100 g	5901867106063
LD-VE2120N-50	50 W		5600 lm		1190 × 295 × 35		2200 g	5901867106094
LD-VE4060N-50			5500 lm		595 × 595 × 37		3200 g	5901867106049



Technical & industrial
fixtures



- PL Zestaw linek do podwieszania paneli, 1,5 m
 EN Set of cables for a panel suspension 1,5 m
 RU Комплект кабелей для подвески панели 1,5 м
 UK Комплект монтажних тросиків для підвішування панелей



LK-PANELX4-00	metal, metal, металл, метал.	4	5902801270307
---------------	------------------------------	---	---------------

- PL Zestaw do podtynkowego montażu paneli
 EN Set of the built-in panel mount
 RU Набор встроенного монтажа панелей
 UK Комплект для скритого монтажу панелей



ZM-PANELSC-00	metal, metal, металл, метал.	4	5901867158079
---------------	------------------------------	---	---------------

- PL Zestaw do montażu ściennego
 EN Set for wall mount
 RU Набор для настенных креплений
 UK Комплект для настінного монтажу панелей



ZM-PANELSU-00	metal, metal, металл, метал.	4	5901867158055
---------------	------------------------------	---	---------------



PL Rama do montażu natynkowego paneli
 EN Surface mounted panel frames
 RU Рамка для накладного монтажа панелей
 UK Рамка для поверхневого монтажу панелей

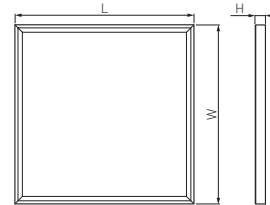

RM-TIG60X60-00	600 x 600 x 45	metal, metal, металл, метал.	biały, white, белый, білий.	5902801287091
----------------	----------------	------------------------------	-----------------------------	---------------

PL Rama do montażu natynkowego paneli
 EN Surface mounted panel frames
 RU Рамка для накладного монтажа панелей
 UK Рамка для поверхневого монтажу панелей

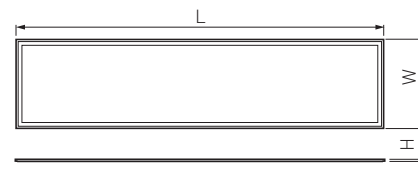

RM-DE625X625-00	625 x 625 x 43	aluminium, aluminium, алюминий, алюміній.	biały, white, белый, білий.	5902801073137
RM-KNG60X60-00	600 x 600 x 43			5901867168580
RM-KNG300X600-00	600 x 300 x 43			5901867179753
RM-KNG300X120-00	1200 x 300 x 43			5901867179777
RM-MA60X60-00	600 x 600 x 43		szary, grey, серый, сірий.	5901867157249
RM-MA30X120-00	1200 x 300 x 43			5901867168566

Technical & industrial fixtures





OPRAWY PRZEMYSŁOWE LED
INDUSTRIAL LED FIXTURES
СВЕТОДИОДНЫЕ ПРОМЫШЛЕННЫЕ СВЕТИЛЬНИКИ
СВІТЛОДІОДНІ ПРОМИСЛОВІ СВІТИЛЬНИКИ

PL Oprawa LED hermetyczna
EN Hermetic LED fixture
RU Герметический светодиодный светильник
UK Герметичний світлодіодний світильник

BERGA

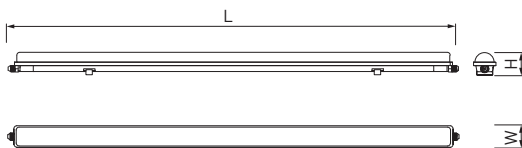

	W	LN				LxWxH mm			
LD-BERGA50W-30	50 W	10	● 4000 K	7000 lm	ABS/PC	1190 x 75 x 77	szary, grey, серый, сірий.	1360 g	5902801253188
LD-BERGA70W-30	70 W	7		9800 lm		1570 x 75 x 77		1740 g	5902801253263



PL Oprawa LED hermetyczna
EN Hermetic LED fixture
RU Герметический светодиодный светильник
UK Герметичний світлодіодний світильник

BETIS



	W	LN				LxWxH mm			
LD-BETISD50W-30	50 W	22	● 4000 K	6000 lm	PC	1200 x 75 x 95	biały, white, белый, білий.	680 g	5902801015670
LD-BETISD70W-30	70 W	15		8400 lm		1500 x 75 x 95		1350 g	5902801015687



Technical & industrial
fixtures

PL Oprawa LED hermetyczna
 EN Hermetic LED fixture
 RU Герметический светодиодный светильник
 UK Герметичний світлодіодний світильник

HEROS

LED



60 W



Technical & industrial
fixtures



LD-HER60W12-NB	60 W	20	● 4000 K	8400 lm	aluminium + szkło hartowane; aluminium + tempered glass; алюминий + закаленное стекло; алюміній + гартоване скло.	biały, white, белый, білий.	4200 g	5902801274404

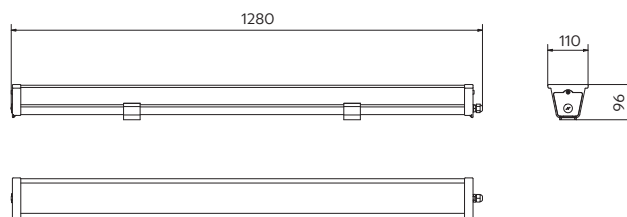



PL Oprawa LED hermetyczna
EN Hermetic LED fixture
RU Герметический светодиодный светильник
UK Герметичний світлодіодний світильник

OMNIA BIS

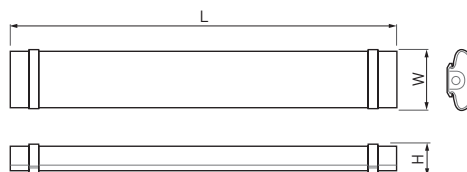

Model	Power (W)	Color Temp (K)	Light Output (lm)	Material	Dimensions (LxWxH mm)	Color	Weight (g)	Barcode
LD-OMN060-30B	30 W	● 4000 K	3000 lm	PC	640 × 50 × 85	biały, white, белый, білий.	400 g	5902801038587
LD-OMN120-60B	60 W		6000 lm		1240 × 50 × 85		670 g	5902801038693
LD-OMN150-70B	70 W		7000 lm		1540 × 50 × 85		750 g	5902801038686



PL Oprawa LED hermetyczna
EN Hermetic LED fixture
RU Герметический светодиодный светильник
UK Герметичний світлодіодний світильник

OMNIA MAX

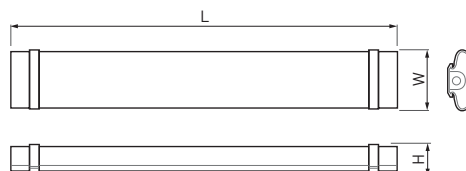

Model	Power (W)	Beam Angle (°)	Color Temp (K)	Light Output (lm)	Material	Dimensions (LxWxH mm)	Color	Weight (g)	Barcode
LD-OMN120-75M	75 W	10	● 4000 K	7500 lm	PC	1242 × 118 × 56	biała, white, белый, білий.	1250 g	5902801025846
LD-OMN150-90M	90 W	9		9000 lm		1542 × 118 × 56		1500 g	5902801025853



PL Oprawa LED hermetyczna
EN Hermetic LED fixture
RU Герметический светодиодный светильник
UK Герметичний світлодіодний світильник

LUMIA

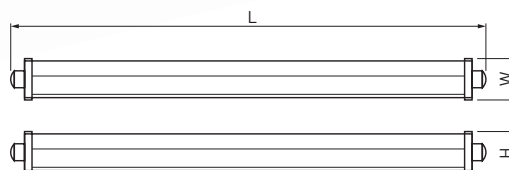

Folder	W	LN	Color	Light	Material	LxWxH mm	Color	Weight	Barcode
LD-LUM120-30P	36 W	10	● 4000 K	3600 lm	PC	1205 x 49 x 56	biały, white, белый, білий.	670 g	5901867155733
LD-LUM150-30P	45 W	8		4500 lm		1512 x 49 x 56		680 g	5901867155757



PL Oprawa LED natynkowa
EN Surface mounted LED fixture
RU Светодиодный накладной светильник
UK Світлодіодний світильник для поверхневого монтажу

ZEFIR PRO

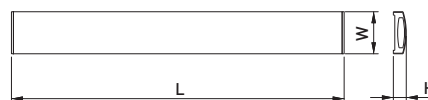

Folder	W	Color	Light	Material	LxWxH mm	Color	PF	Weight	Barcode
LD-ZFPL24W06-NB	24 W	● 4000 K	2200 lm	aluminium, aluminium, алюминий, алюміній.	591 x 148,5 x 52,5	biały, white, белый, білий.	PF > 0,5	825 g	5902801218170
LD-ZFPL48W12-NB	48 W		4400 lm				1191 x 148,5 x 52,5	PF > 0,9	1475 g



Technical & industrial fixtures

PL Oprawa LED hermetyczna
EN Hermetic LED fixture
RU Герметический светодиодный светильник
UK Герметичний світлодіодний світильник

ONTARIO

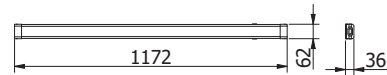

Technical & industrial
fixtures



LD-ONT120-36	36 W	7	● 4000 K	3600 lm	PC	biały, white, белый, білий	470 g	5902801247255
--------------	------	---	----------	---------	----	----------------------------------	-------	---------------



PL Akcesoria
EN Accessories
RU Аксессуары
UK Аксесуари



LD-ONTEND-00	biały, white, белый, білий	20 g	5902801247453
LD-ONTMCI-00		30 g	5902801245060
LD-ONTPWR-00		60 g	5902801245022

PL Oprawa LED natynkowa
 EN Surface mounted LED fixture
 RU Светодиодный накладной светильник
 UK Світлодіодний світильник для поверхневого монтажу

ASPEN

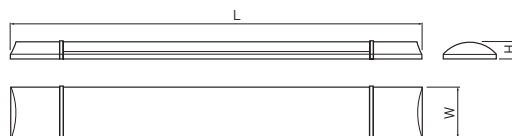

Model	Power (W)	Color Temperature (K)	Lumen (lm)	Material	Dimensions (LxWxH mm)	Color	Power Factor (PF)	Weight (g)	Barcode
LD-OLL20W-CB	20 W	3000 K	1800 lm	PC	600 × 68 × 23	biały, white белый, білий.	PF > 0,5	190 g	5902801284151
LD-OLL20W-NB		4000 K							5902801010453
LD-OLL40W-CB	40 W	3000 K	3600 lm		1200 × 68 × 23		PF > 0,9	360 g	5902801285011
LD-OLL40W-NB		4000 K							5902801010460
LD-OLL50W-CB	50 W	3000 K	4500 lm		1500 × 68 × 23		PF > 0,9	475 g	5902801284274
LD-OLL50W-NB		4000 K							5902801010477



Technical & industrial fixtures

PL Oprawa LED natynkowa
 EN Surface mounted LED fixture
 RU Светодиодный накладной светильник
 UK Світлодіодний світильник для поверхневого монтажу

JASMIN

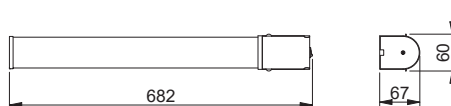

Model	Power (W)	Color Temperature (K)	Lumen (lm)	Material	Dimensions (LxWxH mm)	Color	Power Factor (PF)	Weight (g)	Barcode
LD-JAS15W-40	15 W	4000 K	1200 lm	PC	682 × 67 × 60	biały, white, белый, білий.	PF > 0,5	760 g	5902801200540



PL Oprawa LED natynkowa
EN Surface mounted LED fixture
RU Светодиодный накладной светильник
UK Світлодіодний світильник для поверхневого монтажу

VELA

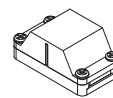

Aksesoria,
Accessories,
Аксессуары,
Аксесуари:
LZ-KO12KO-10

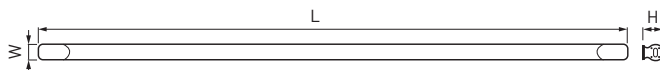

Model	Power (W)	Beam Angle	Color Temperature (K)	Light Output (lm)	Material	Dimensions (LxWxH mm)	Color	Weight (g)	Barcode
LD-NPCT809W-40	9 W	5	4000 K	700 lm	PC	600 × 28 × 35	biały, white, белый, білий.	87 g	5902801017568
LD-NPCT818W-40	18 W			1400 lm		1200 × 28 × 35		143 g	5902801017575
LD-NPCT818W-RD	18 W		-	-		1200 × 28 × 35		143 g	5902801229534
LD-NPCT818W-GR			-	-		1200 × 28 × 35		143 g	5902801229473
LD-NPCT818W-BL			-	-		1200 × 28 × 35		143 g	5902801230776



PL Oprawa LED natynkowa
EN Surface mounted LED fixture
RU Светодиодный накладной светильник
UK Світлодіодний світильник для поверхневого монтажу

VELA

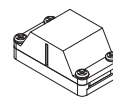

Aksesoria,
Accessories,
Аксессуары,
Аксесуари:
LZ-KO12KO-10

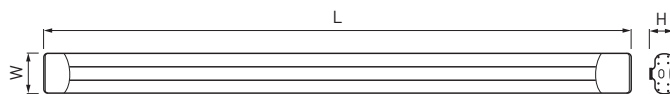

Model	Power (W)	Beam Angle	Color Temperature (K)	Light Output (lm)	Material	Dimensions (LxWxH mm)	Color	Weight (g)	Barcode
LD-NPCT836W-40	36 W	5	4000 K	2800 lm	PC	1200 × 77 × 35	biały, white, белый, білий.	284 g	5902801017582







PLAFONIERY I OPRAWY KANAŁOWE LED
LED CEILING AND BULKHEAD FIXTURES
ПОТОЛОЧНЫЕ СВЕТИЛЬНИКИ И СВЕТИЛЬНИКИ ЖКХ
СВІТЛОДІЮДНІ СВЕТИЛЬНИКИ ТА СВЕТИЛЬНИКИ ЖКГ

PL Plafoniera LED
EN LED ceiling light fixture
RU Светодиодный светильник
UK Світлодіодний світильник

BESA

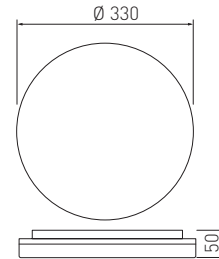

Technical & industrial fixtures

LD-BES24WOK-30	24 W	3000 K	2400 lm	PC	biała, white, белый, білий.	880 g	5902801289255
LD-BES24WOK-40		4000 K					5902801041532



PL Plafoniera LED
EN LED ceiling light fixture
RU Светодиодный светильник
UK Світлодіодний світильник

BESA

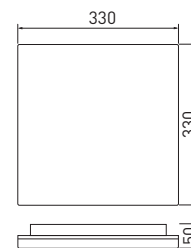

LD-BES24WKW-30	24 W	3000 K	2400 lm	PC	biała, white, белый, білий.	880 g	5902801289385
LD-BES24WKW-40		4000 K					5902801041891



STARS

Technical & industrial
 fixtures



Folder	Wattage	Color	Light Output	Material	Dimensions (mm)	Color	PF	Weight	Barcode
LD-STARS24W-NB	24 W	● 4000 K	1800 lm	PC + metal	ø410 × 105	biały, white, белый, білий	PF > 0,9	1180 g	5902801274053
LD-STARS48W-NB	48 W		3600 lm	PC + metal PC + металл PC + метал	ø510 × 110			1840 g	5902801274107

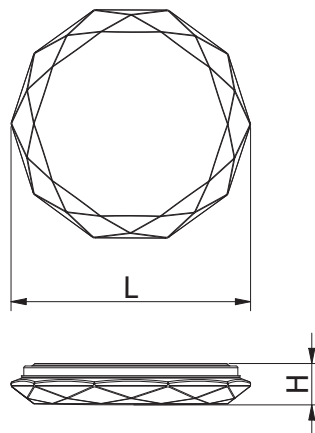



PL Plafoniera LED
 EN LED ceiling light fixture
 RU Светодиодный светильник
 UK Світлодіодний світильник

MOON

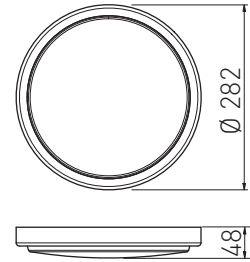

Technical & industrial fixtures

LD-MOON12W-NB	12 W	● 4000 K	1200 lm	PC/PC	biała, white, белый, білий.	630 g	5902801219443
LD-MOON18W-NB	18 W		1800 lm				5902801219498



PL Plafoniera LED
 EN LED ceiling light fixture
 RU Светодиодный светильник
 UK Світлодіодний світильник

ATLANTIS

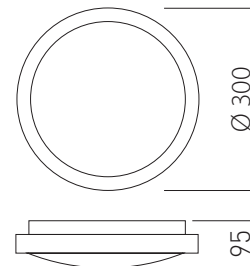

LD-ATL16OK-40	16 W	● 4000 K	960 lm	akryl + aluminium; acrylic + aluminium; акрил + алюминий.	biały, white, белый, білий.	628 g	5901867190505



PL Plafoniera LED
EN LED ceiling light fixture
RU Светодиодный светильник
UK Світлодіодний світильник

ATLANTOS PLUS

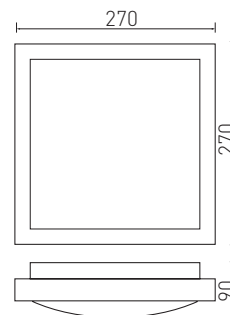

LD-ATL16KW-40	16 W	● 4000 K	960 lm	akryl + aluminium; acrylic + aluminium; акрил + алюминий; акрил + алюминій.	srebrny, silver, серебряный, срібний.	940 g	5902801278921



PL Plafoniera LED
EN LED ceiling light fixture
RU Светодиодный светильник
UK Світлодіодний світильник

SATURN

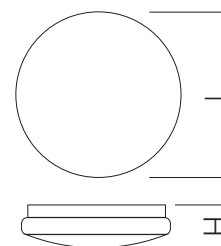

LD-SATU12W-NB	12 W	● 4000 K	IP 44	PF>0,5	900 lm	ø260 × 60	akryl, acrylic, акрил, акрил.	biały, white белый, білий.	390 g	5902801274466
LD-SATU18W-NB	18 W				1300 lm	ø330 × 60			650 g	5902801274237
LD-SATU24W-NB	24 W				1600 lm	ø380 × 65			1000 g	5902801274138
LD-SATU45W-NB	45 W		IP 40	PF>0,9	3600 lm	ø480 × 60			1400 g	5902801270635



Technical & industrial fixtures

PL Plafoniera LED
EN LED ceiling light fixture
RU Светодиодный светильник
UK Світлодіодний світильник

EMPOLIO

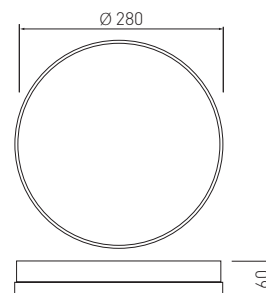

Technical & industrial
fixtures



LD-EMP24W-40	24 W	● 4000 K	2200 lm	PC/PC	biała, white, белый, білий	900 g	5902801274411
--------------	------	----------	---------	-------	-------------------------------------	-------	---------------



PL Plafoniera LED
EN LED ceiling light fixture
RU Светодиодный светильник
UK Світлодіодний світильник

EMPOLIO

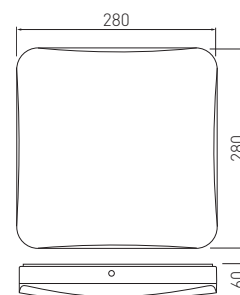

LD-EMP24W-40KW	24 W	● 4000 K	2200 lm	PC/PC	biała, white, белый, білий	1100 g	5902801274473
----------------	------	----------	---------	-------	-------------------------------------	--------	---------------



PL Plafoniera LED z mikrofalowym czujnikiem ruchu
 EN LED ceiling light fixture with a microwave motion sensor
 RU Светодиодный светильник с микроволновым датчиком движения
 UK Світлодіодний світильник з мікрохвильовим датчиком руху

EMPOLIO

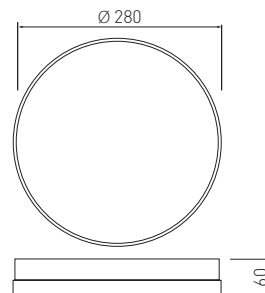

LD-EMP24WM-40	24 W	● 4000 K	2200 lm	PC/PC	biała, white, белый, білий	900 g	5902801274428



Technical & industrial fixtures

PL Plafoniera LED z mikrofalowym czujnikiem ruchu
 EN LED ceiling light fixture with a microwave motion sensor
 RU Светодиодный светильник с микроволновым датчиком движения
 UK Світлодіодний світильник з мікрохвильовим датчиком руху

EMPOLIO

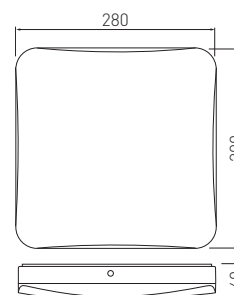

LD-EMP24WM-40KW	24 W	● 4000 K	2200 lm	PC/PC	biała, white, белый, білий	1100 g	5902801274558



PL Plafoniera LED
EN LED ceiling light fixture
RU Светодиодный светильник
UK Світлодіодний світильник



TOKIO

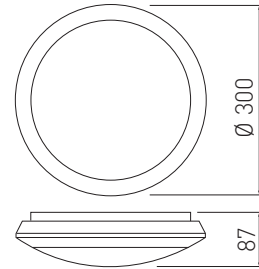

Technical & industrial
fixtures



LD-TOK22W-00	22 W	● 4000 K	2000 lm	PC / PC	biała, white, белый, білий.	1000 g	5902801283888



PL Plafoniera LED z mikrofalowym czujnikiem ruchu
EN LED ceiling light fixture with a microwave motion sensor
RU Светодиодный светильник с микроволновым датчиком движения
UK Світлодіодний світильник з мікрохвильовим датчиком руху



TOKIO

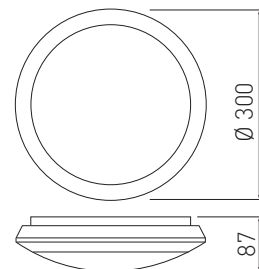

LD-TOK16WD-40	16 W	● 4000 K	1200 lm	PC/PC	biała, white, белый, білий.	1000 g	5902801001840
LD-TOK22WD-40	22 W		2000 lm				5902801001826



PL Plafoniera LED z czujnikiem zmierzchowym
EN LED ceiling light fixture with dusk sensor
RU Светодиодный светильник с сумеречным датчиком
UK Світлодіодний світильник з датчиком сутінків

TOKIO

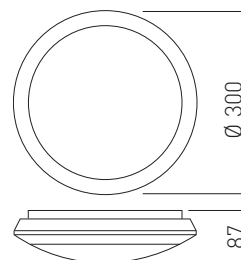

LD-TOK16WP-40	16 W	4000 K	1200 lm	PC/PC	biała, white, белый, білий.	1000 g	5902801001840



Technical & industrial
fixtures

PL Plafoniera LED z mikrofalowym czujnikiem ruchu
EN LED ceiling light fixture with microwave sensor
RU Светодиодный светильник с микроволновым датчиком движения
UK Світлодіодний світильник з мікрохвильовим датчиком руху

OSAKA

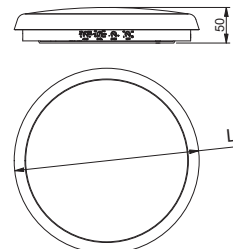

LD-OSA16WD-40	16 W	4000 K	1450 lm	PC/PC	Ø 260	biała, white, белый, білий.	5902801284892
LD-OSA22WD-40	22 W		2000 lm		Ø 300		
						920 g	5902801282188





PL Plafoniera LED z mikrofalowym czujnikiem ruchu
 EN LED ceiling fixture with microwave motion sensor
 RU Светодиодный светильник с микроволновым датчиком движения
 UK Світлодіодний світильник з мікрохвильовим датчиком руху

WENUS

Technical & industrial
fixtures

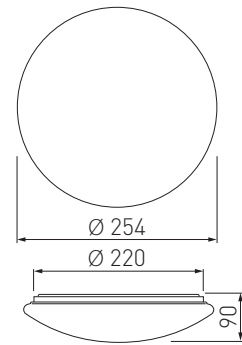

LD-WENUSD13-LED	13 W	4000 K	1100 lm	tworzywo sztuczne, plastic, пластмасса, пластик.	biała, white, белый, білий.	450 g	5902801033353

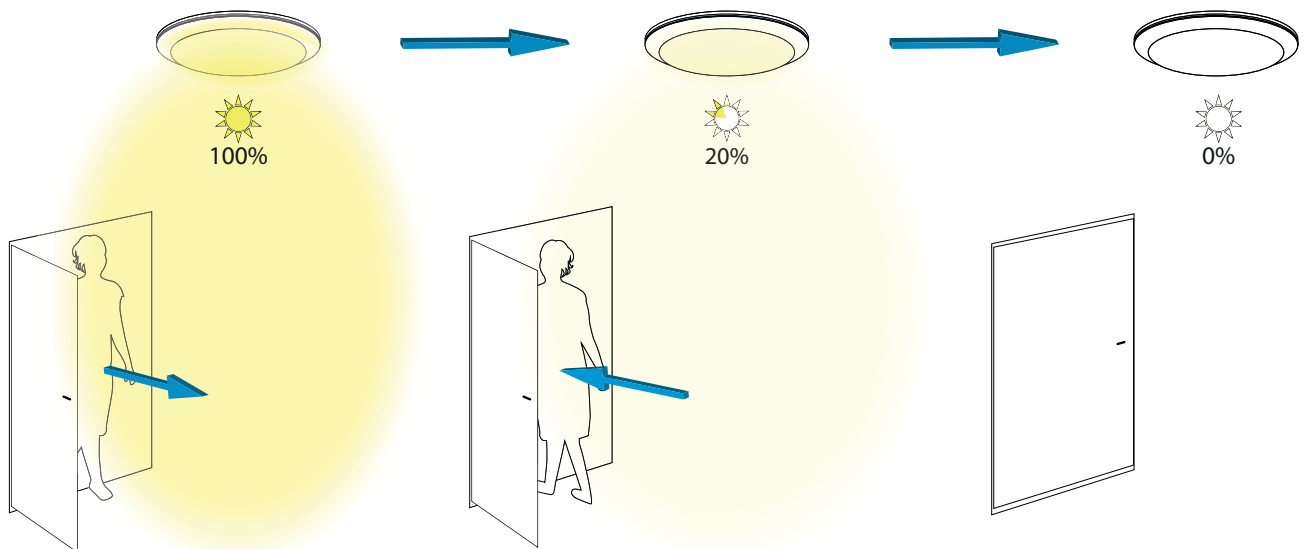

PL Plafoniera LED
EN LED ceiling light fixture
RU Светодиодный светильник
UK Світлодіодний світильник

WENUS DUO

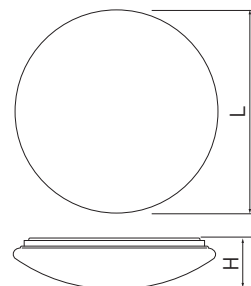

Model	Power (W)	Color Temp (K)	Light Output (lm)	Material	Dimensions (mm)	Color	Weight (g)	Barcode
LD-WEND13W-40	13 W	● 4000 K	800 lm	akryl, acrylic, акрил, акрил.	260 x 90	biała, white, белый, білий.	461 g	5901867190628
LD-WEND18W-40	18 W		1200 lm		335 x 105		560 g	5901867190529
LD-WEND24W-40	24 W		1500 lm		380 x 105		580 g	5901867190642



PL Plafoniera LED z mikrofalowym czujnikiem ruchu
EN LED ceiling fixture with microwave motion sensor
RU Светодиодный светильник с микроволновым датчиком движения
UK Світлодіодний світильник з мікрохвильовим датчиком руху

WENUS DUO

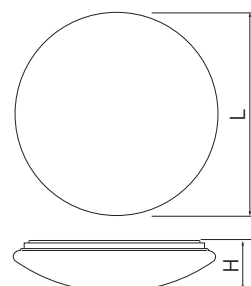

Model	Power (W)	Color Temp (K)	Light Output (lm)	Material	Dimensions (mm)	Color	Weight (g)	Barcode
LD-WENDM18W-40	18 W	● 4000 K	1200 lm	akryl, acrylic, акрил, акрил.	335 x 105	biała, white, белый, білий.	571 g	5901867190581
LD-WENDM24W-40	24 W		1500 lm		380 x 105		590 g	5901867190604



Technical & industrial fixtures

PL Plafoniera LED z czujnikiem ruchu
 EN LED ceiling light fixture with motion sensor
 RU Светодиодный светильник с датчиком движения
 UK Світлодіодний світильник з датчиком руху

LED
 inside
16 W

motion sensor
3 years warranty

LOGOS

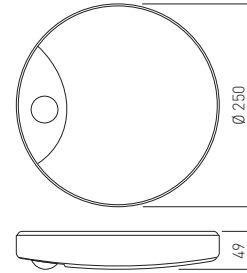

Technical & industrial fixtures

LD-LOG16W-LED	16 W	4000 K	1200 lm	tworzywo sztuczne, plastic, пластмасса, пластик.	biała, white, белый, білий.	508 g	5901867197085

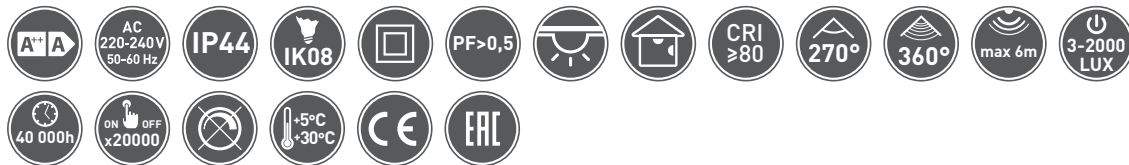

PL Plafoniera LED z czujnikiem ruchu
 EN LED ceiling light fixture with motion sensor
 RU Светодиодный светильник с датчиком движения
 UK Світлодіодний світильник з датчиком руху

LED
 inside
13-24 W

motion sensor
3 years warranty

ITALIA

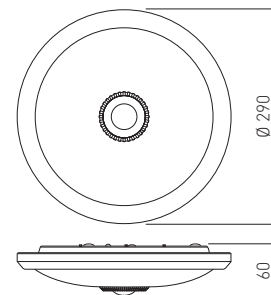

OS-ITL12W-LED	12 W	4000 K	900 lm	PC	biała, white, белый, білий.	560 g	5901867158291
OS-ITL16W-LED	16 W		1200 lm				5901867197016



PL Plafoniera LED z czujnikiem ruchu
EN LED ceiling light fixture with motion sensor
RU Светодиодный светильник с датчиком движения
UK Світлодіодний світильник з датчиком руху

ITALIA

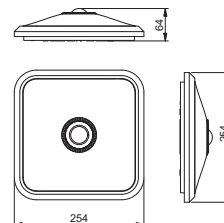

OS-ITL12WKW-LED	12 W	4000 K	900 lm	PC	biała, white, белый, білий.	420 g	5902801282089



Technical & industrial fixtures

PL Plafoniera LED z czujnikiem zmierzchowym
EN LED ceiling light fixture with dusk sensor
RU Светодиодный светильник с сумеречным датчиком
UK Світлодіодний світильник з датчиком сутінків

MACARI

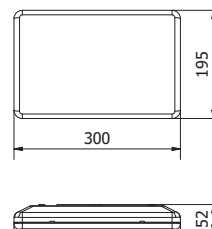

LD-MCR12W-NB	12 W	4000 K	950 lm	PC	biała, white, белый, білий.	680 g	5902801294143



PL Oprawa kanałowa LED
EN LED bulkhead fixture
RU Светодиодный ЖКХ светильник
UK Світлодіодний ЖКГ світильник

LUXIA

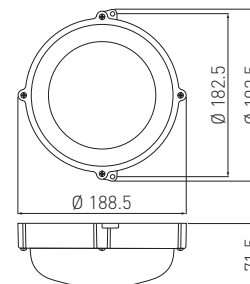

LD-KALU100K-40	10 W	● 4000 K	700 lm	PC / PC	biała, white, белый, білий.	250 g	5901867169204
----------------	------	----------	--------	---------	-----------------------------	-------	---------------



PL Oprawa kanałowa LED
EN LED bulkhead fixture
RU Светодиодный ЖКХ светильник
UK Світлодіодний ЖКГ світильник

LUXIA

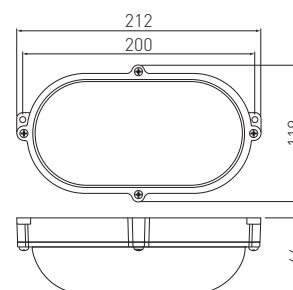

LD-KALU100W-40	10 W	● 4000 K	700 lm	PC / PC	biała, white, белый, білий.	250 g	5901867169228
----------------	------	----------	--------	---------	-----------------------------	-------	---------------



PL Oprawa kanałowa LED
EN LED bulkhead fixture
RU Светодиодный ЖКХ светильник
UK Світлодіодний ЖКГ світильник

TWIST

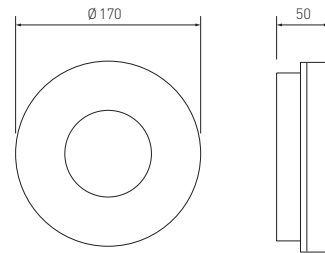

LD-TWI10WOK-40	10 W	● 4000 K	750 lm	PC	czarny, black, черный, чорний.	300 g	5902801041303
----------------	------	----------	--------	----	--------------------------------------	-------	---------------



Technical & industrial
fixtures

PL Oprawa kanałowa LED
EN LED bulkhead fixture
RU Светодиодный ЖКХ светильник
UK Світлодіодний ЖКГ світильник

TWIST

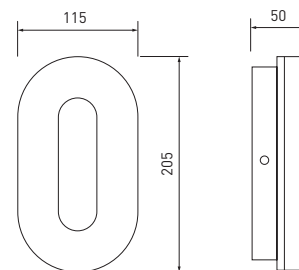

LD-TWI10WOW-40	10 W	● 4000 K	750 lm	PC	czarny, black, черный, чорний.	300 g	5902801042058
----------------	------	----------	--------	----	--------------------------------------	-------	---------------



PL Oprawa kanałowa LED
EN LED bulkhead fixture
RU Светодиодный ЖКХ светильник
UK Світлодіодний ЖКГ світильник



DELTA

Technical & industrial
fixtures

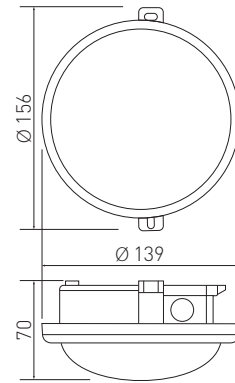

LD-DELOR6W0-NB	6 W	● 4000 K	400 lm	ABS / PC	biały, white, белый, білий.	170 g	5901867191083



PL Oprawa kanałowa LED
EN LED bulkhead fixture
RU Светодиодный ЖКХ светильник
UK Світлодіодний ЖКГ світильник



DELTA

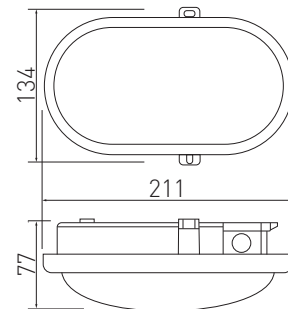

LD-DELOW6W0-NB	6 W	● 4000 K	400 lm	ABS / PC	biały, white, белый, білий.	170 g	5901867191090



PL Oprawa kanałowa LED z czujnikiem ruchu
EN LED bulkhead fixture with motion sensor
RU Светодиодный ЖКХ светильник с датчиком движения
UK Світлодіодний ЖКГ світильник з датчиком руху

DELTA

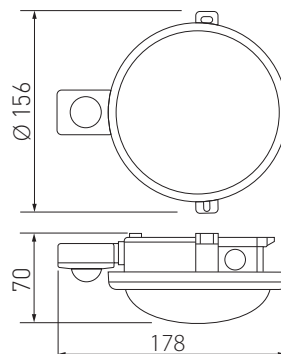

LD-DELOR6WC-NB	6 W	4000 K	400 lm	ABS / PC	biały, white, белый, білий.	207 g	5901867191106

Technical & industrial fixtures

PL Oprawa kanałowa LED z czujnikiem ruchu
EN LED bulkhead fixture with motion sensor
RU Светодиодный ЖКХ светильник с датчиком движения
UK Світлодіодний ЖКГ світильник з датчиком руху

DELTA

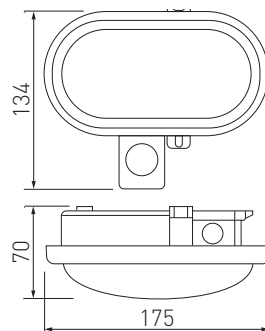

LD-DELOW6WC-NB	6 W	4000 K	400 lm	ABS / PC	biały, white, белый, білий.	207 g	5901867191113



OPRAWY LED TYPU DOWNLIGHT
LED DOWNLIGHTS
СВЕТИЛЬНИКИ ТИПА DOWNLIGHT
СВІТИЛЬНИКИ ТИПУ DOWNLIGHT

- PL Oprawa LED typu downlight natynkowa
EN Surface mounted LED downlight
RU Светодиодный накладной светильник downlight
UK Світлодіодний світильник типу downlight поверхневого монтажу

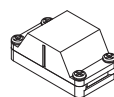

Aksesoria,
Accessories,
Аксессуары,
Аксесуари:
LZ-KOI2KO-10

ORIS PLUS

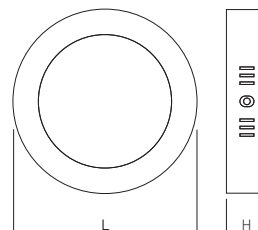

Model	Power (W)	Color Temperature (K)	Light Output (lm)	Dimensions (mm)	PF	Weight (g)	Barcode
LD-ORN07W-CBP	7 W	3000 K	560 lm	ø 120 × 32	PF > 0,5	340 g	5902801243080
LD-ORN07W-NBP		4000 K					5902801243271
LD-ORN13W-CBP	13 W	3000 K	1020 lm	ø 170 × 32		490 g	5902801243486
LD-ORN13W-NBP		4000 K					5902801243028
LD-ORN19W-CBP	19 W	3000 K	1520 lm	ø 224 × 32		610 g	5902801242779
LD-ORN19W-NBP		4000 K					5902801243523
LD-ORN24W-CBP	24 W	3000 K	2000 lm	ø 303 × 32		1000 g	5902801243417
LD-ORN24W-NBP		4000 K					5902801243738



Technical & industrial fixtures

- PL Oprawa LED typu downlight wpuszczana
EN Recessed LED downlight
RU Светодиодный встраиваемый светильник downlight
UK Світлодіодний світильник типу downlight врізний

ORIS PLUS

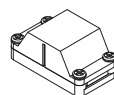

Aksesoria,
Accessories,
Аксессуары,
Аксесуари:
LZ-KOI2KO-10

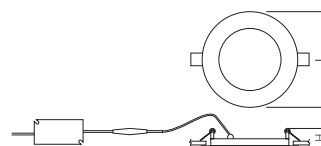

Model	Power (W)	Color Temperature (K)	Light Output (lm)	Material	Dimensions (mm)	PF	Weight (g)	Barcode
LD-ORW03W-CBP	3 W	3000 K	200 lm	aluminium, aluminium, алюминий, алюміній.	ø 90 × 22	PF > 0,5	150 g	5902801243066
LD-ORW03W-NBP		4000 K						5902801243318
LD-ORW07W-CBP	7 W	3000 K	560 lm		ø 118 × 22		220 g	5902801243073
LD-ORW07W-NBP		4000 K						5902801243165
LD-ORW13W-CBP	13 W	3000 K	1020 lm		ø 168 × 22		350 g	5902801243035
LD-ORW13W-NBP		4000 K						5902801243042
LD-ORW19W-CBP	19 W	3000 K	1520 lm		ø 225 × 22		550 g	5902801243578
LD-ORW19W-NBP		4000 K						5902801243134
LD-ORW24W-CBP	24 W	3000 K	2000 lm		ø 300 × 22		880 g	5901867127624
LD-ORW24W-NBP		4000 K						5901867158390





- PL Oprawa LED typu downlight natynkowa
 EN Surface mounted LED downlight
 RU Светодиодный накладной светильник downlight
 UK Світлодіодний світильник типу downlight поверхневого монтажу

MATIS PLUS

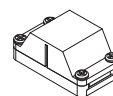

Akcesoria,
Accessories,
Аксессуары,
Аксессуары:
LZ-KOI2KO-10

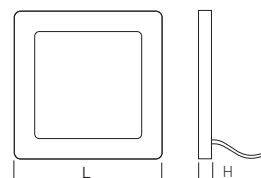

Model	Power (W)	Color Temp (K)	Beam Angle (°)	Material	Dimensions (mm)	PF	Weight (g)	Barcode
LD-MAN07W-CBP	7 W	3000 K	560 lm	aluminium, aluminium, алюминий, алюміній.	120 × 32	PF > 0,5	340 g	5902801244186
LD-MAN07W-NBP		4000 K						5902801244087
LD-MAN13W-CBP	13 W	3000 K	1020 lm		170 × 32		490 g	5902801244179
LD-MAN13W-NBP		4000 K						5902801244445
LD-MAN19W-CBP	19 W	3000 K	1520 lm		223 × 32		750 g	5902801244452
LD-MAN19W-NBP		4000 K						5902801244414
LD-MAN24W-CBP	24 W	3000 K	2000 lm		300 × 32		1300 g	5902801243776
LD-MAN24W-NBP		4000 K						5902801243332



Technical & industrial fixtures

- PL Oprawa LED typu downlight wpuszczana
 EN Recessed LED downlight
 RU Светодиодный встраиваемый светильник downlight
 UK Світлодіодний світильник типу downlight врізний

MATIS PLUS

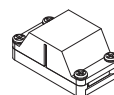

Akcesoria,
Accessories,
Аксессуары,
Аксессуары:
LZ-KOI2KO-10

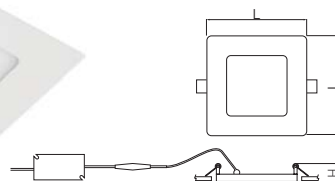

Model	Power (W)	Color Temp (K)	Beam Angle (°)	Material	Dimensions (mm)	PF	Weight (g)	Barcode
LD-MAW03W-CBP	3 W	3000 K	200 lm	aluminium, aluminium, алюминий, алюміній.	86 × 22	PF > 0,5	150 g	5902801243448
LD-MAW03W-NBP		4000 K						5902801243653
LD-MAW07W-CBP	7 W	3000 K	560 lm		120 × 22		240 g	5902801243721
LD-MAW07W-NBP		4000 K						5902801243615
LD-MAW13W-CBP	13 W	3000 K	1020 lm		170 × 22		400 g	5902801243462
LD-MAW13W-NBP		4000 K						5902801243912
LD-MAW19W-CBP	19 W	3000 K	1520 lm		224 × 22		640 g	5902801243639
LD-MAW19W-NBP		4000 K						5902801243981
LD-MAW24W-CBP	24 W	3000 K	2000 lm		300 × 22		1100 g	5902801244155
LD-MAW24W-NBP		4000 K						5902801244056



PL Oprawa LED typu downlight
EN Surface mounted LED downlight
RU Светодиодный светильник downlight
UK Світильники типу downlight

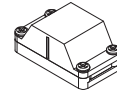

Aksesoria,
Accessories,
Аксессуары,
Аксесуари:
LZ-KOI2KO-10



MOZA

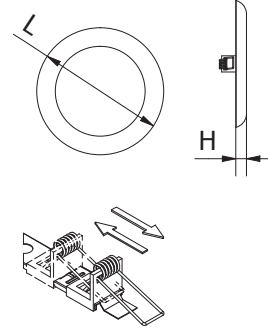

LD-MZ12WOK-NB	12 W	● 4000 K	1000 lm	PC	ø 180 × 16	Ø 65-155 mm	300 g	5902801229497
LD-MZ18WOK-NB	18 W		1500 lm		ø 230 × 16	Ø 65-205 mm	390 g	5902801229329



PL Oprawa LED typu downlight
EN Surface mounted LED downlight
RU Светодиодный светильник downlight
UK Світильники типу downlight

MOZA

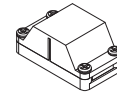

Aksesoria,
Accessories,
Аксессуары,
Аксесуари:
LZ-KOI2KO-10

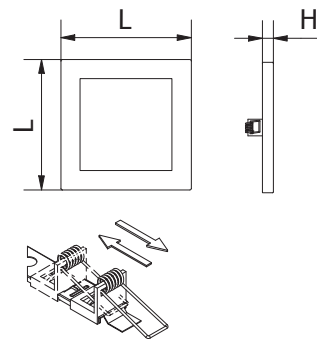

LD-MZ12WKW-NB	12 W	● 4000 K	1000 lm	PC	180 × 16	Ø 65 – 155 mm	480 g	5902801229510
LD-MZ18WKW-NB	18 W		1500 lm		230 × 16	Ø 65 – 205 mm	570 g	5902801229428



PL Oprawa LED typu downlight 2 w 1 natynkowa/wpuszczana
 EN LED downlight fixture 2 in 1 surface mounted/recessed
 RU Светодиодный светильник 2 в 1 накладной / встраиваемый
 UK Світлодіодний світильник типу downlight 2 в 1 поверхневий/врізний

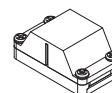

Akcesoria,
Accessories,
Аксессуары,
Аксесуари:
LZ-KO12KO-10

SAMBA

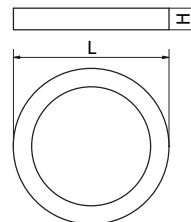

LD-SMBOK09W-21	9 W	● 4000 K	675 lm	PC	ø 115 x 35	PF > 0,5	150 g	5902801219504
LD-SMBOK16W-21	16 W		1200 lm		ø 177 x 35		300 g	5902801074202
LD-SMBOK20W-21	20 W		1600 lm		ø 245 x 35		515 g	5902801073328



PL Oprawa LED typu downlight 2 w 1 natynkowa/wpuszczana
 EN LED downlight fixture 2 in 1 surface mounted/recessed
 RU Светодиодный светильник 2 в 1 накладной / встраиваемый
 UK Світлодіодний світильник типу downlight 2 в 1 поверхневий/врізний

SAMBA

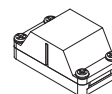

Akcesoria,
Accessories,
Аксессуары,
Аксесуари:
LZ-KO12KO-10

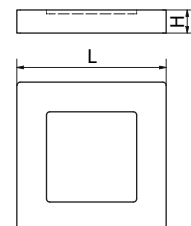

LD-SMBKW09W-21	9 W	● 4000 K	675 lm	PC	115 x 35	PF > 0,5	180 g	5902801219344
LD-SMBKW16W-21	16 W		1200 lm		171 x 35		365 g	5902801074219
LD-SMBKW24W-21	24 W		1800 lm		226 x 35		565 g	5902801073304

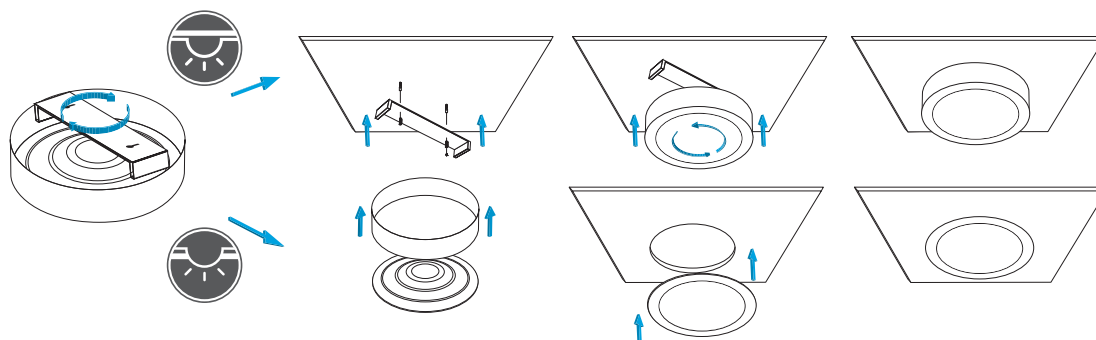

PL Oprawa LED typu downlight 2 w 1 natynkowa/wpuszczana
 EN LED downlight fixture 2 in 1 surface mounted/recessed
 RU Светодиодный светильник 2 в 1 накладной / встраиваемый
 UK Світлодіодний світильник типу downlight 2 в 1 поверхневий/врізний

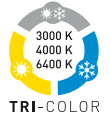

BOLERO

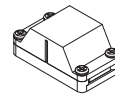

Aksesoria,
Accessories,
Аксессуары,
Аксесуари:
LZ-KOI2KO-10

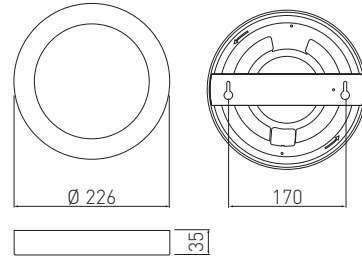

LD-BLROK18W-61	18 W	<ul style="list-style-type: none"> ● 3000 K ● 4000 K ● 6400 K 	1600 lm	aluminium + PC; aluminium + PC; алюминий + PC; алюміній + PC.	560 g	5902801020117
----------------	------	--	---------	--	-------	---------------



PL Oprawa LED typu downlight 2 w 1 natynkowa/wpuszczana
 EN LED downlight fixture 2 in 1 surface mounted/recessed
 RU Светодиодный светильник 2 в 1 накладной / встраиваемый
 UK Світлодіодний світильник типу downlight 2 в 1 поверхневий/врізний

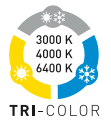

BOLERO

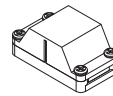

Aksesoria,
Accessories,
Аксессуары,
Аксесуари:
LZ-KOI2KO-10

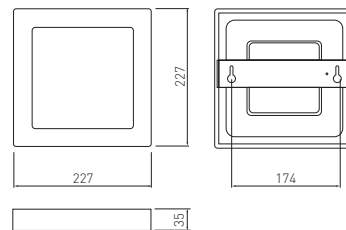

LD-BLRKW18W-61	18 W	<ul style="list-style-type: none"> ● 3000 K ● 4000 K ● 6400 K 	1600 lm	aluminium + PC; aluminium + PC; алюминий + PC; алюміній + PC.	475 g	5902801020100
----------------	------	--	---------	--	-------	---------------





TRI-COLOR

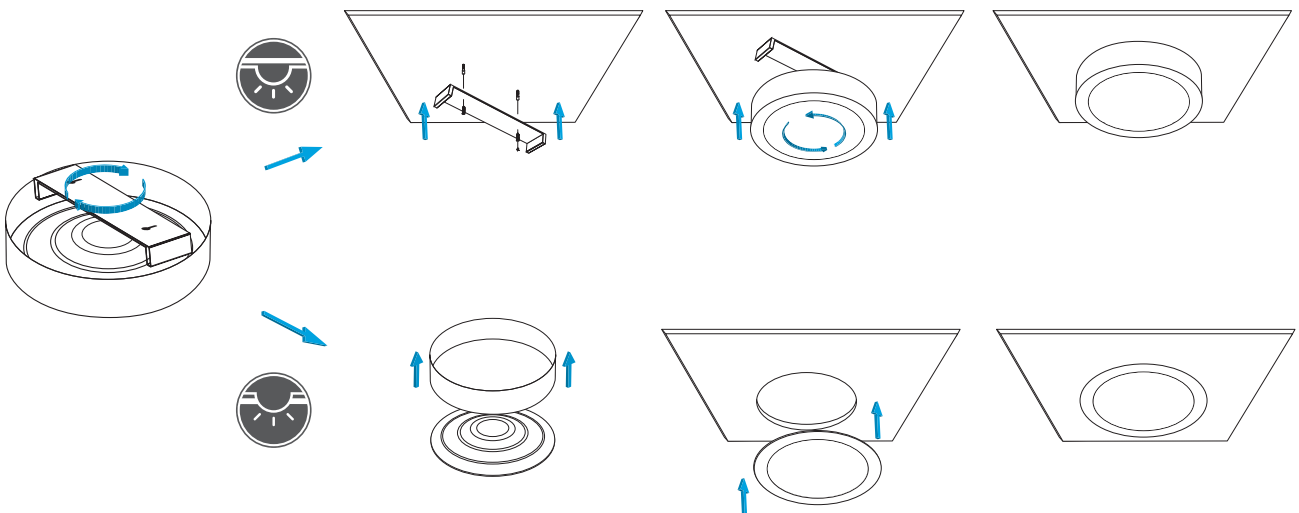
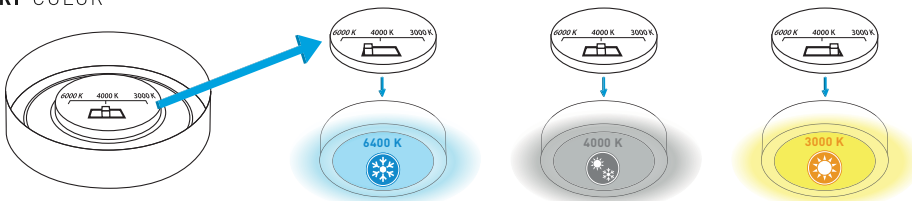

PL Oprawa LED typu downlight natynkowa
 EN Surface mounted LED downlight
 RU Светодиодный накладной светильник downlight
 UK Світлодіодний світильник типу downlight поверхневого монтажу

TWINS

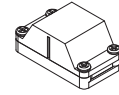

Aksesoria,
Accessories,
Аксессуары,
Аксесуари:
LZ-KO12KO-10

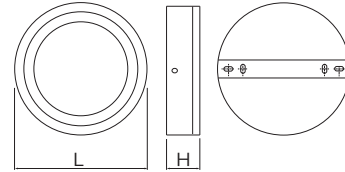

	W	Color	lm	Material	LxH mm	g	Barcode
LD-TWN09W-CB	9 W (6W+3W)	● 3000 K	640 lm	aluminium + PC; aluminium + PC;	ø 147 x 37	290 g	5901867191045
LD-TWN16W-CB	16 W (12W+4W)		1140 lm	алюминий + PC; алюміній + PC.	ø 195 x 37	480 g	5901867191052



PL Oprawa LED typu downlight wpuszczana
 EN Recessed LED downlight
 RU Светодиодный встраиваемый светильник downlight
 UK Світлодіодний світильник типу downlight врізний

TWINS

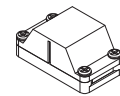

Aksesoria,
Accessories,
Аксессуары,
Аксесуари:
LZ-KO12KO-10

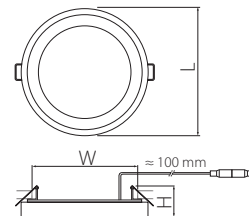

	W	Color	lm	Material	LxWxH mm	g	Barcode
LD-TWW09W-CB	9 W (6W+3W)	● 3000 K	640 lm	aluminium + PC; aluminium + PC;	ø 145 x 130 x 30	200 g	5901867191069
LD-TWW16W-CB	16 W (12W+4W)		1140 lm	алюминий + PC; алюміній + PC.	ø 190 x 175 x 30	324 g	5901867191076



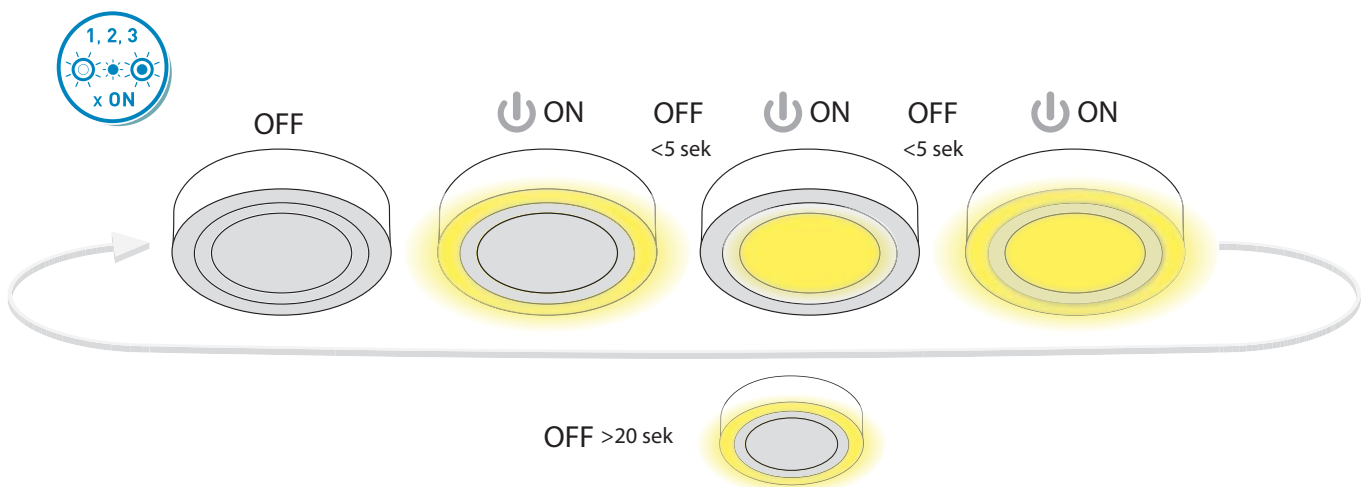

PL Oprawa LED typu downlight wpuszczana
EN Recessed LED downlight
RU Светодиодный встраиваемый светильник downlight
UK Світлодіодний світильник типу downlight врізний

SOLERO II

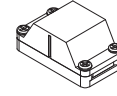

Aksesoria,
Accessories,
Аксессуары,
Аксесуарі:
LZ-KO12KO-10

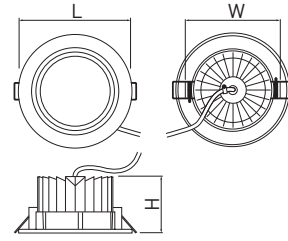

	W				LxWxH mm	PF		
LD-SO206W-NB	6 W	● 4000 K	420 lm	aluminium, aluminium, алюминий, алюміній.	ø 100 x 90 x 60	PF > 0,5	160 g	5901867190932
LD-SO212W-NB	12 W		880 lm		ø 130 x 110 x 65		346 g	5901867190949
LD-SO218W-NB	18 W		1350 lm		ø 160 x 150 x 75		496 g	5901867190956
LD-SO224W-NB	24 W		1600 lm		ø 190 x 175 x 75		646 g	5901867190963



PL Oprawa LED typu downlight wpuszczana
EN Recessed LED downlight
RU Светодиодный встраиваемый светильник downlight
UK Світлодіодний світильник типу downlight врізний

VERIS

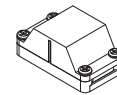

Aksesoria,
Accessories,
Аксессуары,
Аксесуарі:
LZ-KO12KO-10

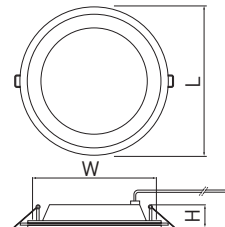

	W				LxWxH mm		
LD-VEW06W-CB	6 W	● 3000 K	400 lm	szkło + aluminium, glass + aluminium, стекло + алюминий, скло + алюміній.	ø 100 x 75 x 30	175 g	5901867191014
LD-VEW12W-CB	12 W		700 lm		ø 160 x 130 x 32	350 g	5901867191021
LD-VEW18W-CB	18 W		1300 lm		ø 200 x 170 x 32	540 g	5901867191038





PL Oprawa LED typu downlight wpuszczana
EN Recessed LED downlight
RU Светодиодный встраиваемый светильник downlight
UK Світлодіодний світильник типу downlight врізний

VOLARE

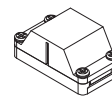

Aksesoria,
Accessories,
Аксессуары,
Аксесуари:
LZ-KOI2KO-10

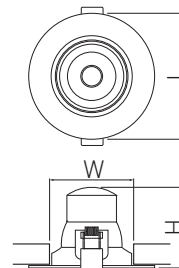

LD-VLROK0538-CB	5 W	● 3000 K	400 lm	ø 90 × 75 × 45	PC	75 g	5902801015830
LD-VLROK0538-NB		● 4000 K					5902801299254
LD-VLROK1038-CB	10 W	● 3000 K	800 lm	ø 104 × 80 × 60		120 g	5902801015885
LD-VLROK1038-NB		● 4000 K					5902801299438

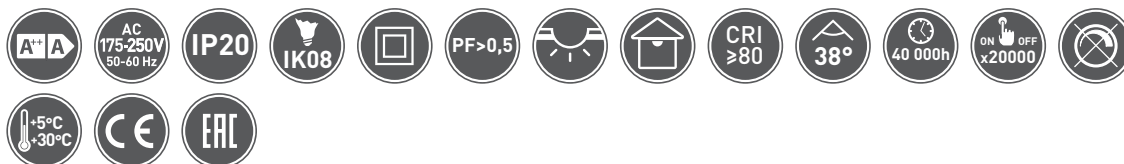

PL Oprawa LED typu downlight wpuszczana
EN Recessed LED downlight
RU Светодиодный встраиваемый светильник downlight
UK Світлодіодний світильник типу downlight врізний

VOLARE

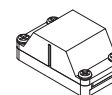

Aksesoria,
Accessories,
Аксессуары,
Аксесуари:
LZ-KOI2KO-10

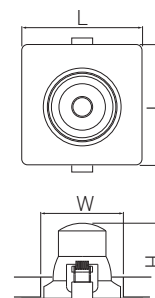

LD-VLRKW0538-CB	5 W	● 3000 K	400 lm	90 × 75 × 45	PC	75 g	5902801015823
LD-VLRKW0538-NB		● 4000 K					5902801299063
LD-VLRKW1038-CB	10 W	● 3000 K	800 lm	104 × 80 × 60		120 g	5902801015854
LD-VLRKW1038-NB		● 4000 K					5902801299353





PL Oprawa LED typu downlight wpuszczana
 EN Recessed LED downlight
 RU Светодиодный встраиваемый светильник downlight
 UK Світлодіодний світильник типу downlight врізний

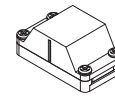

Aksesoria,
 Accessories,
 Аксессуары,
 Аксесуари:
 LZ-KO12KO-10

TORONTO

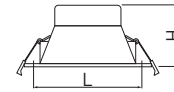
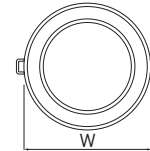

Model	Power (W)	Color Temp (K)	Beam Angle (°)	Material	Dimensions (mm)	Weight (g)	Barcode
LD-TOR08W-NB	8 W	● 4000 K	600 lm	aluminium + PC, aluminium + PC, алюминий + PC, алюміній + PC.	ø 90-100 × 115 × 58	135 g	5901867190970
LD-TOR12W-NB	12 W		900 lm		ø 120-130 × 145 × 61	189 g	5901867190987
LD-TOR20W-NB	20 W		1600 lm		ø 155-170 × 190 × 75	288 g	5901867190994
LD-TOR24W-NB	24 W		1900 lm		ø 185-205 × 225 × 85	379 g	5901867191007



PL Oprawa LED typu downlight wpuszczana
 EN Recessed LED downlight
 RU Светодиодный встраиваемый светильник downlight
 UK Світлодіодний світильник типу downlight врізний

AREZZO

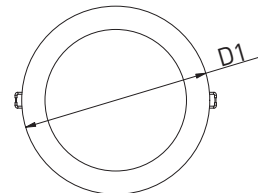

Model	Power (W)	Color Temp (K)	Beam Angle (°)	Material	Dimensions (mm)	Weight (g)	Barcode
LD-ARZ18W-CCT	18 W	● 3000 K	1800 lm	aluminium, aluminium, алюминий, алюміній.	Ø 145x30	500 g	5902801281884
LD-ARZ25W-CCT	25 W	● 4000 K	2500 lm		Ø 190x30	525 g	5902801278112
LD-ARZ35W-CCT	35 W	● 6400 K	3500 lm		Ø 225x30	660 g	5902801278136





722

723

724

725

726

727

728

729



PL Oprawa LED typu downlight wpuszczana
 EN Recessed LED downlight
 RU Светодиодный встраиваемый светильник downlight
 UK Світлодіодний світильник типу downlight врізний

FARO

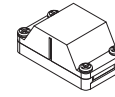

Aksesoria,
Accessories,
Аксессуары,
Аксесуары:
LZ-KO12KO-10

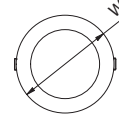

LD-FAR10W-40	10 W	● 4000 K	800 lm	ø 90-100 × 110 × 70	PF > 0,5	aluminium, aluminium, алюминий, алюміній.	410 g	5902801255342
LD-FAR20W-40	20 W		1600 lm	ø 150-160 × 170 × 90	PF > 0,9		880 g	5902801253201



PL Oprawa LED typu downlight natynkowa
 EN Surface mounted LED downlight
 RU Светодиодный накладной светильник downlight
 UK Світлодіодний світильник типу downlight поверхневого монтажу

KARIS

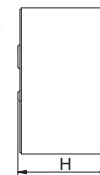
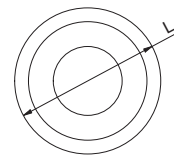

LD-KAR18W-CCT	18 W	● 3000 K	1800 lm	aluminium, aluminium, алюминий, алюміній.	Ø 170 x 124	940 g	5902801210013
LD-KAR25W-CCT	35 W	● 4000 K ● 6400 K					

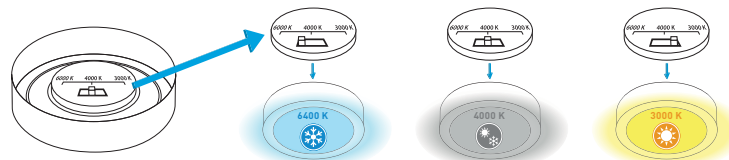

PL Oprawa LED typu downlight wpuszczana
EN Recessed LED downlight
RU Светодиодный встраиваемый светильник downlight
UK Світлодіодний світильник типу downlight врізний

ALTA

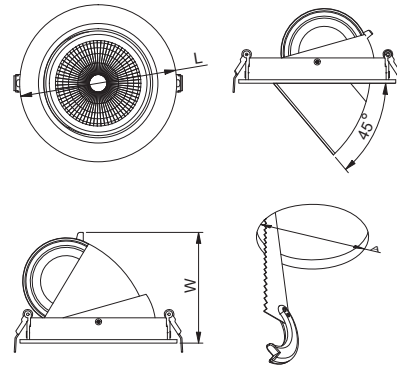

	W			LxW mm	A	PF			
LD-ALT20W-NB	20 W	● 4000 K	2000 lm	ø 145 x 102	ø 120-130	PF > 0,9	aluminium, aluminium, алюминий, алюміній.	1160 g	5902801210464
LD-ALT35W-NB	35 W		3500 lm	ø 180 x 127	ø 165-170			1360 g	5902801210532



PL Oprawa LED typu downlight natynkowa
EN Surface mounted LED downlight
RU Светодиодный накладной светильник downlight
UK Світлодіодний світильник типу downlight поверхневого монтажу

ARCCO

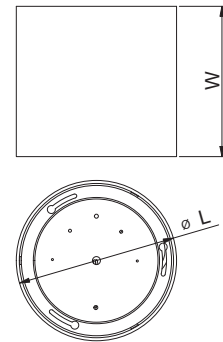

	W			LxW mm				
LD-ARC15W-NB	15 W	● 4000 K	1350 lm	ø 130 x 100	aluminium, aluminium, алюминий, алюміній.	500 g	5902801278679	
LD-ARC25W-NB	25 W		2250 lm	ø 160 x 150		520 g	5902801278778	
LD-ARC30W-NB	30 W		2700 lm	ø 195 x 130		1000 g	5902801278747	



Technical & industrial
fixtures



NAŚWIETLACZE LED
LED FLOODLIGHTS
СВЕТОДИОДНЫЕ ПРОЖЕКТОРЫ
СВІТЛОДІОДНІ ПРОЖЕКТОРИ

PL Naświetlacz LED
EN LED floodlight
RU Светодиодный прожектор
UK Світлодіодний прожектор

VIPER

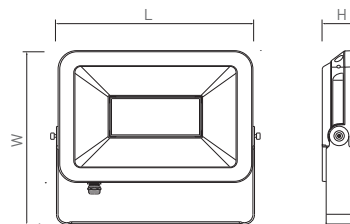

LD-VIPERS30W-40	30 W	● 4000 K	2700 lm	aluminium + szkło, aluminium + glass, алюминий + стекло, алюміній + скло.	LxWxH mm	☼	♻️	860 g	5902801266195	
LD-VIPERS50W-40	50 W		4500 lm					229 x 214 x 35	1150 g	5902801266263
LD-VIPERS100W-40	100 W		10000 lm					306 x 268 x 58	2200 g	5902801251764
LD-VIPERS150W-40	150 W		15000 lm					367 x 315 x 72	3500 g	5902801251771



PL Naświetlacz LED
EN LED floodlight
RU Светодиодный прожектор
UK Світлодіодний прожектор

iMAX

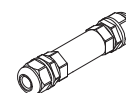

Aksesoria,
Accessories,
Аксесуары,
Аксесуари:
WZL-2

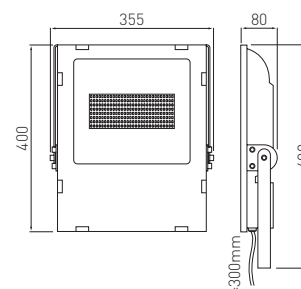

LD-IMAXC200W-64	200 W	● 6400 K	18000 lm	aluminium + szkło; aluminium + glass; алюминий + стекло; алюміній + скло.	LxWxH mm	☼	♻️	6000 g	5902801000805



Technical & industrial
fixtures

PL Naświetlacz LED z czujnikiem ruchu
 EN LED floodlight with motion sensor
 RU Светодиодный прожектор с датчиком движения
 UK Світлодіодний прожектор з датчиком руху

iNEXT

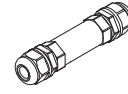

Aksesoria,
Accessories,
Аксессуары,
Аксесуари:
WZL-2

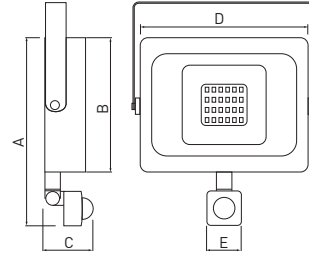

Technical & industrial
fixtures



					A × B × C × D × E (mm)			
LD-INEXT10W-64	10 W	6400 K	800 lm	aluminium + szkło, aluminium + glass, алюминий + стекло, алюміній + скло.	150 × 88 × 50 × 110 × 40	czarny, black, черный, чорний.	250 g	5902801007682
LD-INEXT20W-64	20 W		1600 lm		180 × 120 × 50 × 160 × 40		500 g	5902801007699
LD-INEXT30W-64	30 W		2400 lm		180 × 120 × 50 × 160 × 40		800 g	5902801007705
LD-INEXT50W-64	50 W		4000 lm		210 × 145 × 50 × 190 × 40		1200 g	5902801007712



PL Naświetlacz LED
 EN LED floodlight
 RU Светодиодный прожектор
 UK Світлодіодний прожектор

iNEXT

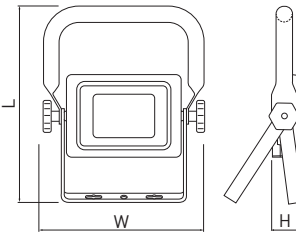

					L×W×H mm			
LD-INEXT30WP-64	30 W	6400 K	2400 lm	aluminium + szkło, aluminium + glass, алюминий + стекло, алюміній + скло.	247 × 218 × 38	czarny, black, черный, чорний.	800 g	5902801007729
LD-INEXT50WP-64	50 W		4000 lm		270 × 256 × 38		1200 g	5902801007736





PL Naświetlacz LED
EN LED floodlight
RU Светодиодный прожектор
UK Світлодіодний прожектор

iLUX

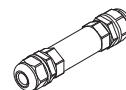

Aksesoria,
Accessories,
Аксессуары,
Аксесуари:
WZL-2

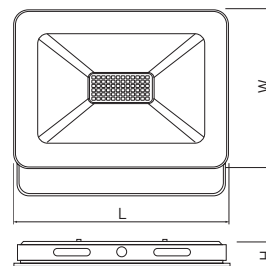

LD-ILUXC10W-64	10 W	6400 K	800 lm	>0,5	PC + szkło; PC + glass; PC + стекло; PC + скло.	128 × 92 × 31	biały, white, белый, білий.	160 g	5901867191267
LD-ILUXCC10W-64							czarny, black, черный, чорний.		5902801005268
LD-ILUXC20W-64	20 W	6400 K	1600 lm	>0,5	PC + szkło; PC + glass; PC + стекло; PC + скло.	170 × 130 × 36	biały, white, белый, білий.	470 g	5901867191243
LD-ILUXCC20W-64							czarny, black, черный, чорний.		5902801005282
LD-ILUXC30W-64I	30 W	6400 K	2400 lm	>0,9	PC + szkło; PC + glass; PC + стекло; PC + скло.	230 × 170 × 36	biały, white, белый, білий.	780 g	5902801046865
LD-ILUXCC30W-64							czarny, black, черный, чорний.		5902801005305
LD-ILUXC50W-64	50 W	6400 K	4000 lm	>0,9	PC + szkło; PC + glass; PC + стекло; PC + скло.	300 × 220 × 36	biały, white, белый, білий.	1230 g	5901867191229
LD-ILUXCC50W-64							czarny, black, черный, чорний.		5902801005329



PL Naświetlacz LED
EN LED floodlight
RU Светодиодный прожектор
UK Світлодіодний прожектор

iLUX

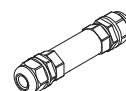

Aksesoria,
Accessories,
Аксессуары,
Аксесуари:
WZL-2

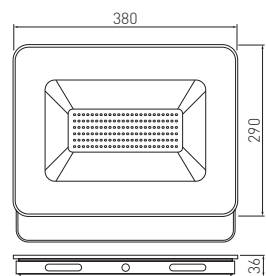

LD-ILUXC100W-64	100 W	6400 K	8000 lm	PC + szkło, PC + glass, PC + стекло, PC + скло.	biały, white, белый, білий.	2000 g	5901867191267
LD-ILUXCC100W-64					czarny, black, черный, чорний.		5901867191243







OPRAWY LED TYPU HIGH BAY
HIGH BAY LED LUMINAIRES
СВЕТОДИОДНЫЕ HIGH BAY СВЕТИЛЬНИКИ
СВІТЛОДІОДНІ HIGH BAY СВІТИЛЬНИКИ

PL High-bay LED
 EN High-bay LED fixture
 RU Светодиодный светильник High Bay
 UK Світлодіодний світильник High Bay

ARIZONA

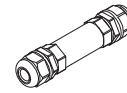

Aksesoria,
 Accessories,
 Аксессуары,
 Аксесуари:
 WZL-2

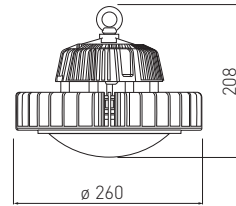

150 W



Technical & industrial fixtures

LD-HB150W-40	150 W	● 4000 K	18000 lm	aluminium, aluminium, алюминий, алюминій.	4500 g	5901867166432



PL Reflektor do High-bay Arizona
 EN Reflector for high-bay Arizona
 RU Рефлектор для highbay Arizona
 UK Рефлектор для highbaya Arizona

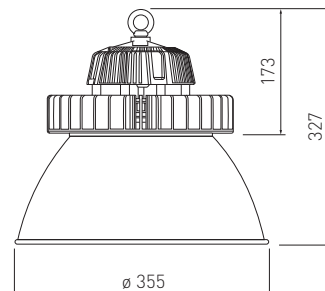

RF-HB150W-40	aluminium, aluminium, алюминий, алюминій.	szary, grey, серый, сірий.	750 g	5901867170583



PL High-bay LED
 EN High-bay LED fixture
 RU Светодиодный светильник High Bay
 UK Світлодіодний світильник High Bay

TEKSAS

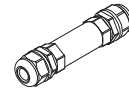

Aksesoria,
 Accessories,
 Аксессуары,
 Аксесуари:
 WZL-2

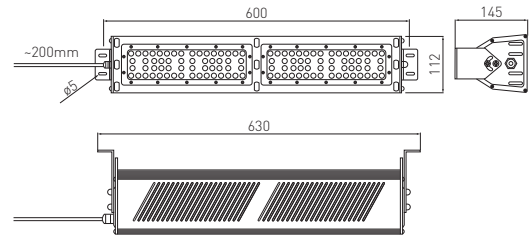

Technical & industrial
 fixtures



LD-TK100W-40	100 W	● 4000 K	12 000 lm	aluminium, aluminium, алюминий, алюминій.	szary, grey, серый, сірий.	3000 g	5902801001970
--------------	-------	----------	-----------	--	-------------------------------	--------	---------------



PL Soczewki wymienne
 EN Replaceable lenses
 RU Сменные линзы
 UK Замінні лінзи



SO-TK060DE-00	60° X 60°	5902801008979
SO-TK090DE-00	90° X 90°	5902801008986
SO-TK612DE-00	60° X 120°	5902801008962
SO-TK069DE-00	60° X 90°	5902801024931

PL High-bay LED
EN High-bay LED fixture
RU Светодиодный светильник High Bay
UK Світлодіодний світильник High Bay

KANSAS

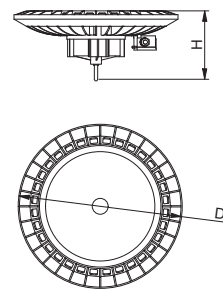

LD-KAN150W-NB	150 W	● 4000 K	19500 lm	aluminium, aluminium, алюминий, алюміній.	czarny, black, черный, білий.	Ø 330x168	2700 g	5902801278815	
LD-KAN200W-NB	200 W		26000 lm			Ø 390x179	3700 g	5902801279386	



PL High-bay LED
EN High-bay LED fixture
RU Светодиодный светильник High Bay
UK Світлодіодний світильник High Bay

DALLAS

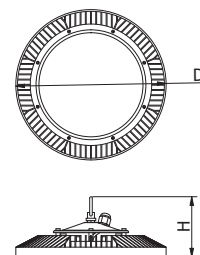

LD-DAL100W-NB	100 W	● 4000 K	10000 lm	aluminium, aluminium, алюминий, алюміній.	LxWxH mm	ø 260 × 104	czarny, black, черный, чорний.	1600 g	5902801244988
LD-DAL150W-NB	150 W		15000 lm			ø 300 × 120		2500 g	5902801247293



Technical & industrial
fixtures



OPRAWY ULICZNE I PARKOWE LED
STREET AND PARK LED LUMINAIRES
СВЕТОДИОДНЫЕ УЛИЧНЫЕ И ПАРКОВЫЕ СВЕТИЛЬНИКИ
СВІТЛОДІОДНІ ВУЛИЧНІ ТА ПАРКОВІ СВЕТИЛЬНИКИ

PL Lampa uliczno-parkowa LED
EN Street and park LED lamp
RU Светодиодная лампа улично-парковая
UK Світлодіодна вулично-паркова лампа

PARKER II

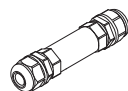

Aksesoria,
Accessories,
Аксессуары,
Аксесуари:
WZL-2

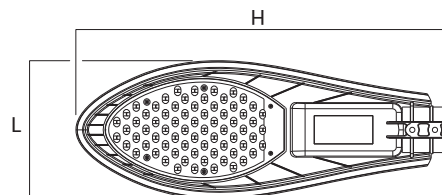

Model	Power (W)	Color Temp (K)	Beam Angle (lm)	Material	Dimensions (mm)	PF	Weight (g)	Barcode
LD-PARK2L30W-40	30 W	4000 K	3000 lm	aluminium, aluminium, алюминий, алюміній.	175 x 470	PF > 0,9	1050 g	5902801286629
LD-PARK2L50W-40	50 W		5000 lm					5902801286513
LD-PARK2L80W-40	80 W		8000 lm		212 x 580		2400 g	5902801286674



PL Lampa uliczno-parkowa LED
EN Street and park LED lamp
RU Светодиодная лампа улично-парковая
UK Світлодіодна вулично-паркова лампа

STELLA

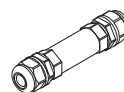

Aksesoria,
Accessories,
Аксессуары,
Аксесуари:
WZL-2

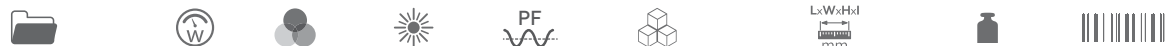
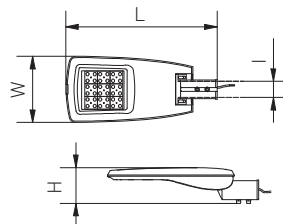

Model	Power (W)	Color Temp (K)	Beam Angle (lm)	PF	Material	Dimensions (mm)	Weight (g)	Barcode
LD-STEL080W-40	80 W	4000 K	10400 lm	PF > 0,9	aluminium, aluminium, алюминий, алюміній.	610 x 256 x 145 x ø60	5000 g	5902801202179
LD-STEL150W-40	150 W		20300 lm			695 x 320 x 145 x ø60	7000 g	5902801202209



Technical & industrial fixtures



- PL Lampa uliczno-parkowa LED
- EN Street and park LED lamp
- RU Светодиодная лампа улично-парковая
- UK Світлодіодна вулично-паркова лампа

ROCKET

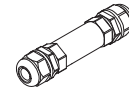

Aksesoria,
Accessories,
Аксессуары,
Аксесуари:
WZL-2

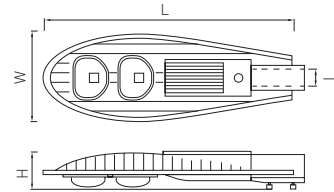

	W	4000 K	lm	Material	LxWxH mm	g	Barcode
LD-LUR050W-40	50 W	● 4000 K	4500 lm	aluminium, aluminium, алюминий, алюміній.	510 × 210 × 70 × ø53	2000 g	5901867166418
LD-LUR100W-40	100 W		9000 lm		720 × 280 × 120 × ø63	4800 g	5901867166425



- PL Adapter do opraw uliczno - parkowych
- EN Adapter for street fixtures
- RU Адаптер для уличных ламп
- UK Адаптер до вуличних світильників



SA1



SA2

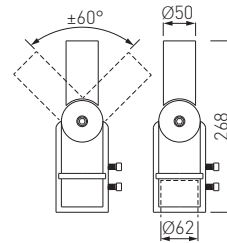

SA1

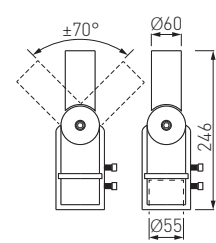

SA2



	g	Barcode
SA1	680 g	5901867190840
SA2	550 g	5901867190864





OPRAWY AWARYJNE LED
LED EMERGENCY LIGHT FIXTURES
АВАРИЙНЫЕ СВЕТИЛЬНИКИ
АВАРІЙНІ СВІТИЛЬНИКИ

PL Oprawa awaryjna LED
EN Emergency LED light fixture
RU Аварийный светодиодный светильник
UK Аварійний світлодіодний світильник

SAHER DUO

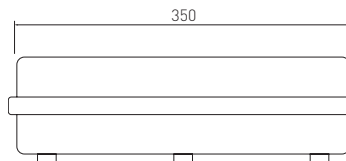
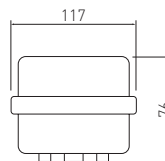

LD-SAHER1-DUO	3 W	1 h	6400 K	300 lm	PC	biały, white, белый, білий.	805 g	5901867198280
LD-SAHER3-DUO		3 h					805 g	5901867198273



Technical & industrial fixtures

PL Oprawa awaryjna LED dwuzadaniowa
EN Combined LED emergency fixture
RU Светодиодный двухфункциональный светильник аварийного освещения
UK Аварійний світлодіодний світильник з двома завданнями

SALED

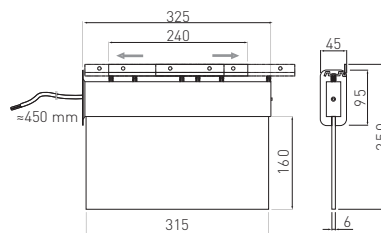

OA-SALED1-08	3 W	1 h	6400 K	aluminium, aluminium, алюминий, алюміній.	chrom, chrome, хром, хром.	910 g	5908231370440
OA-SALED3-08		3 h				910 g	5908231301956



PL Oprawa awaryjna LED dwuzadaniowa
EN Combined LED emergency fixture
RU Аварийный светодиодный светильник с двумя задачами
UK Аварійний світлодіодний світильник з двома завданнями

TERNO

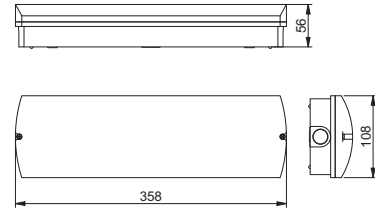

LD-TERNO1-00	3 W	1h	6400 K	250 lm	PC	biały, white, белый, білий.	600 g	5902801283338
LD-TERNO3-00		3h						5902801284786



PL Oprawa awaryjna LED dwuzadaniowa
EN Combined LED emergency fixture
RU Аварийный светодиодный светильник с двумя задачами
UK Аварійний світлодіодний світильник з двома завданнями

CORSO

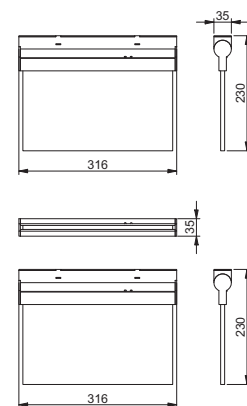

LD-CORSO1-00	3 W	1h	6400 K	PC	biały, white, белый, білий.	960 g	5902801284649
LD-CORSO3-00		3h					5902801284908



PL Oprawa awaryjna LED
EN Emergency fixture LED
RU Аварийный светильник LED
UK Аварійний світильник LED

OGLA

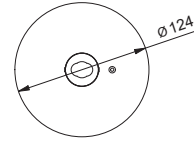
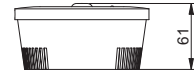

LD-OGLA3W-00	3 W	3 h	6400 K	200 lm	PC	biały, white, белый, білий.	335 g	5902801284755
--------------	-----	-----	--------	--------	----	--------------------------------------	-------	---------------





OPRAWY RASTROWE, KLOSZOWE
LOUVRE FIXTURES
РАСТРОВЫЕ СВЕТИЛЬНИКИ
РАСТРОВІ СВІТИЛЬНИКИ

- PL Oprawa rastrowa natynkowa
- EN Surface mounted louvre fixture
- RU Растровый накладной светильник
- UK Растровий світильник поверхневого монтажу



Aksesoria,
Accessories,
Аксессуары,
Аксесуари:



OS-HERZWKPL4-00

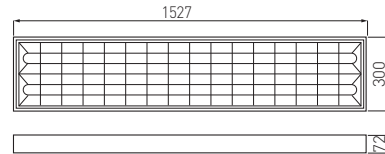

OS-LE150NJ-01	blacha stalowa, steel sheet, стальной лист, сталевий лист.	biały, white, белый, білий.	3750 g	5908231307637



Technical & industrial fixtures

- PL Oprawa świetłówkowa
- EN Fixture for open LED light sources, T8
- RU Светильник для светодиодных ламп T8
- UK Світильник для світлодіодних ламп T8

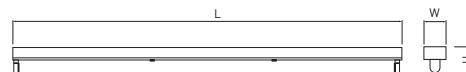

OS-OSL1120S-00	1230 × 42 × 47	blacha stalowa, steel sheet, стальной лист, сталевий лист.		320 g	5901867173737
OS-OSL1150S-00	1530 × 42 × 47			420 g	5901867173751



PL Oprawa świetłówkowa
 EN Fixture for open LED light sources, T8
 RU Светильник для светодиодных ламп T8
 UK Світильник для світлодіодних ламп T8



OS-OSL2120S-00	1230 x 100 x 47	blacha stalowa, steel sheet, стальной лист, сталевий лист.	biały, white, белый, білий.	380 g	5901867173744
OS-OSL2150S-00	1530 x 100 x 47			470 g	5901867173768







OPRAWY PRZEMYSŁOWE
INDUSTRIAL FIXTURES
ПРОМЫШЛЕННЫЕ СВЕТИЛЬНИКИ
ПРОМІСЛОВІ СВІТИЛЬНИКИ

PL Oprawa LED hermetyczna do źródeł światła LED T8
 EN Fixture for LED light sources, T8
 RU Герметический светильник для светодиодных ламп T8
 UK Герметичний світильник для світлодіодних ламп T8

ZEFIR

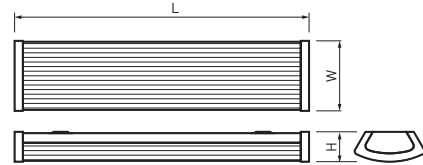

Folder	LxWxH mm	Material	Material	Weight	Barcode
LD-OZE218-00	640 x 152 x 65	ABS + PC + blacha stalowa, ABS + PC + steel sheet, ABS + ПК + листовая сталь, ABS + PC + сталевий лист.	przeźroczysty, clear, прозрачный, прозорий.	700 g	5901867159632
LD-OZE236-00	1250 x 152 x 65			1000 g	5901867151605



Technical & industrial fixtures

PL Oprawa LED hermetyczna do źródeł światła LED T8
 EN Fixture for LED light sources, T8
 RU Герметический светильник для светодиодных ламп T8
 UK Герметичний світильник для світлодіодних ламп T8

ZEFIR

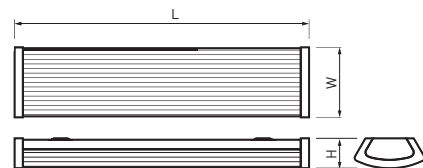

Folder	LxWxH mm	Material	Material	Weight	Barcode
LD-OZE218-01	640 x 152 x 65	ABS + PC + blacha stalowa, ABS + PC + steel sheet, ABS + ПК + листовая сталь, ABS + PC + сталевий лист.	mleczny, soft white, белый матовый, молочный.	700 g	5901867177582
LD-OZE236-01	1250 x 152 x 65			1000 g	5901867177698



PL Oprawa LED hermetyczna do źródeł światła LED T8
 EN Fixture for LED light sources, T8
 RU Герметический светильник для светодиодных ламп T8
 UK Герметичний світильник для світлодіодних ламп T8

HAGEN

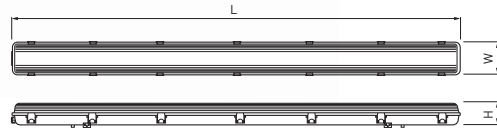

	LxWxH mm				
LD-HAG136-30	1280 x 67 x 50	PC / PC	biała, white, белый, білий.	520 g	5901867194060
LD-HAG158-30	1590 x 67 x 50			900 g	5902801009877
LD-HAG218-30	690 x 115 x 58			1000 g	5901867194053
LD-HAG236-30	1270 x 100 x 60			900 g	5901867154606
LD-HAG258-30	1590 x 110 x 60			1000 g	5901867166395



PL Oprawa LED hermetyczna do źródeł światła LED T8
 EN Fixture for LED light sources, T8
 RU Герметический светильник для светодиодных ламп T8
 UK Герметичний світильник для світлодіодних ламп T8

HELIOS BIS

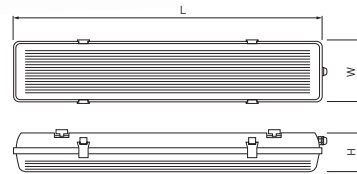

	LxWxH mm				
LD-HEL136B-30	1250 x 152 x 65	szary, grey, серый, сірий.	ABS + PS,	1500 g	5901867163325
LD-HEL218B-30	640 x 152 x 65		ABS + PS,	1500 g	5901867163301
LD-HEL236B-30	1250 x 152 x 65		ABS + PS,	1800 g	5901867163349
LD-HEL258B-30	1550 x 152 x 65		ABS + PS.	2500 g	5901867163363



- PL Zapinka metalowa do opraw HAGEN, boczna
- EN Metal clamp for HAGEN fixtures, side
- RU Металлическая защелка для светильников HAGEN, боковая
- UK Зачіп металевий до світильників HAGEN, боковий



LD-HAG236KL-ME



metal, metal, металл, метал.



5901867189264

- PL Linka stalowa
- EN Steel cable
- RU Стальной трос
- UK Сталевий трос



OS-HERZW1-00



metal, metal, металл, метал.



200 cm



19 g



5902801129551





PLAFONIERY I OPRAWY KANAŁOWE
CEILING AND BULKHEAD FIXTURES

ЖКХ СВЕТІЛЬНИКИ

ЖКГ СВІТІЛЬНИКИ

PL Plafoniera z czujnikiem ruchu
 EN Ceiling fixture with motion sensor
 RU Светильник с датчиком движения
 UK Стельовий світлодіодний світильник з датчиком руху



PLCRKM

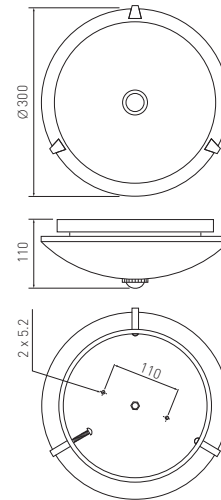

Technical & industrial fixtures

OS-PLCRKM-00	szkło + metal, glass + metal, стекло + металл, скло + метал.	mleczny, soft white, белый матовый, молочный.	1320 g	5908231302885



PL Plafoniera z mikrofalowym czujnikiem ruchu
 EN Ceiling fixture with microwave motion sensor
 RU Светильник с микроволновым датчиком движения
 UK Стельовий світльник з мікрохвильовим датчиком руху



PLCZMI

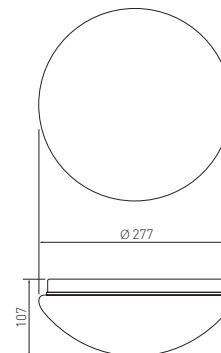

OS-PLCZMI-00	tworzywo, plastic, пластмасса, пластик.	mleczny, soft white, белый матовый, молочный.	500 g	5908231336996



PL Plafoniera z czujnikiem ruchu
EN Ceiling fixture with motion sensor
RU Светильник с датчиком движения
UK Стельовий світильник з датчиком руху

VIZELA

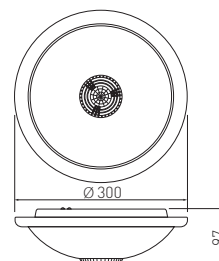

OS-PLCRKZ-00	szkło + metal, glass + metal, стекло + металл, скло + метал.	biały, white, белый, білий.	860 g	5908231339973
--------------	---	--------------------------------------	-------	---------------



PL Plafoniera
EN Ceiling fixture
RU ЖКХ светильник
UK ЖКГ світильник

SILVER

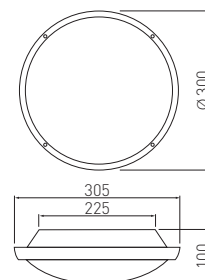

OS-PSL02E27-80	tworzywo sztuczne, plastic, пластмасса, пластик.	szary; osłona mleczna, grey; soft white cover, серый; молочный рассеиватель, сірий; молочний.	1300 g	5901867138835
----------------	---	--	--------	---------------



PL Plafoniera
EN Ceiling fixture
RU ЖКХ светильник
UK ЖКГ світильник

SILVER-X

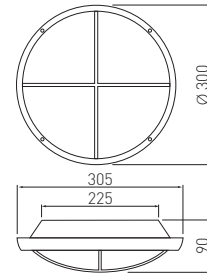

OS-PSLX2E27-80	tworzywo sztuczne, plastic, пластмасса, пластик.	szary; osłona mleczna, grey; soft white cover, серый; молочный рассеиватель, сірий; молочний.	1300 g	5901867138859
----------------	---	--	--------	---------------



PL Oprawa kanałowa
EN Bulkhead fixture
RU ЖКХ Светильник
UK ЖКГ світильник

RINGO

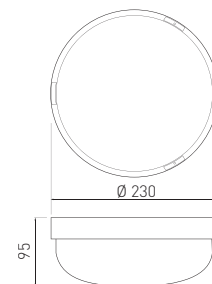

OS-RINGO1-00	korpus: ABS; klosz: szkło hartowane body: ABS, lens: tempered glass, корпус ABS, рассеиватель: закаленное стекло, корпус: ABS; розсіювач: гартоване скло.	biały, white, белый, білий.	900 g	5901867122896
--------------	--	--------------------------------------	-------	---------------



PL Oprawa kanałowa
EN Bulkhead fixture
RU ЖКХ Светильник
UK ЖКГ світильник



IBIZA

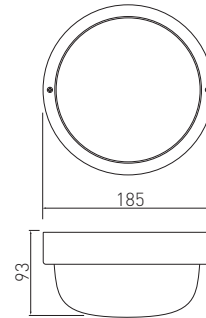

OS-IBBL060-00	korpus ABS; klosz szkło, body: ABS, lens: glass, корпус ABS, рассеиватель стекло, корпус: ABS; розсіювач: скло.	biały, white, белый, білий.	720 g	5908231338464
---------------	--	--------------------------------------	-------	---------------



PL Oprawa kanałowa
EN Bulkhead fixture
RU ЖКХ Светильник
UK ЖКГ світильник



IBIZA

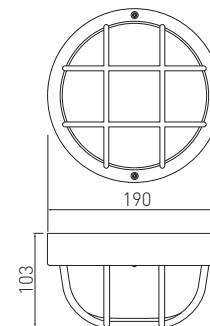

OS-IBKR060-00	korpus: ABS; klosz: szkło, body: ABS, lens: glass, корпус ABS, рассеиватель: стекло, корпус: ABS; розсіювач: скло.	biały, white, белый, білий.	710 g	5908231338457
---------------	---	--------------------------------------	-------	---------------



PL Oprawa kanałowa z czujnikiem ruchu
 EN Bulkhead fixture with motion sensor
 RU ЖКХ Светильник с датчиком движения
 UK ЖКГ світильник з датчиком руху

KACROO

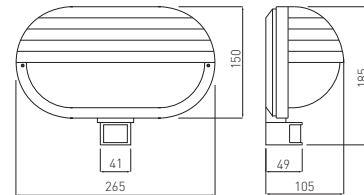

Technical & industrial fixtures

OS-KACROO-00	ABS + PC	biały, white, белый, білий.	580 g	5908231302151



PL Oprawa kanałowa
 EN Bulkhead fixture
 RU ЖКХ Светильник
 UK ЖКГ світильник

SANGUESA – KAY

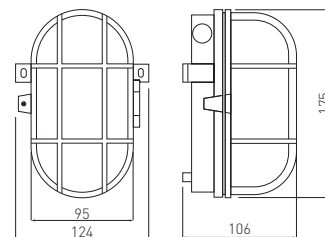

OS-KAY060-10	korpus: ABS; klosz: szkło, body: ABS, lens: glass, корпус ABS, рассеиватель: стекло, корпус: ABS; розсіювач: скло.	czarny, black, черный, чорний.	560 g	5908231302144



PL Oprawa kanałowa
EN Bulkhead fixture
RU ЖКХ Светильник
UK ЖКГ світильник



SANGUESA – KAM

Technical & industrial
fixtures



OS-KAM060-00	korpus: ABS; klosz: szkło, body: ABS, Lens: glass, корпус ABS, рассеиватель: стекло, корпус: ABS; розсіювач: скло.	biały, white, белый, білий.	500 g	5908231394620
OS-KAM060-10		czarny, black, черный, чорний.		5908231337795

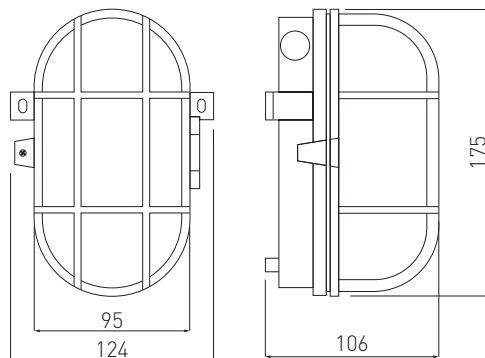





OPRAWY WARSZTATOWE I LATARKI LED
WORKSHOP FIXTURES AND LED FLASHLIGHTS
СВЕТИЛЬНИКИ ДЛЯ МАСТЕРСКОЙ И LED-ФОНАРИ
СВІТИЛЬНИКИ ДЛЯ МАЙСТЕРЕНЬ ТА СВІТЛОДІЮДНІ ЛІХТАРИКИ

PL Oprawa przenośna
EN Portable fixture
RU Переносной светильник
UK Переносний світильник



OS-KAN527-24	60 W	tworzywo + metal, plastic + metal, пластик + металл, пластик + метал.	550 g	5908231301307
--------------	------	--	-------	---------------



PL Oprawa przenośna z magnesem
EN Portable fixture with magnet
RU Переносной светильник с магнитом
UK Переносний світильник з магнітом



OS-KAN527-24M	60 W	tworzywo + metal, plastic + metal, пластик + металл, пластик + метал.	550 g	5901867122827
---------------	------	--	-------	---------------





PL Oprawa przenośna świetłówkowa
 EN Portable fluorescent lamp fixture
 RU Переносной люминесцентный светильник
 UK Переносний світильник люмінесцентний

Technical & industrial
 fixtures



OS-KAX527-10

tworzywo, plastic, пластмасса, пластик.

5908231301291



PL Oprawa przenośna
 EN Portable fixture
 RU Переносной светильник
 UK Переносний світильник



OS-KAG508-10

tworzywo, plastic, пластмасса, пластик.

5908231301284



PL Latarka LED
EN LED Flashlight
RU LED-фонарь
UK Світлодіодний ліхтарик

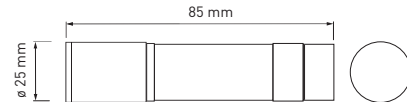

LT-LK3WBL-60	3 W	6400 K	150 lm	aluminium, aluminium, алюминий, алюміній.	35 g	5902801260063



PL Latarka LED
EN LED Flashlight
RU LED-фонарь
UK Світлодіодний ліхтарик

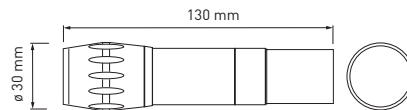

LT-LKSZ3W-60	5 W	6400 K	300 lm	aluminium, aluminium, алюминий, алюміній.	130 g	5902801260124



Technical & industrial
fixtures



PL Latarka LED
EN LED Flashlight
RU LED-фонарь
UK Світлодіодний ліхтарик

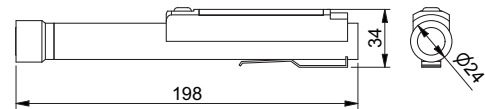

Technical & industrial
fixtures



LT-LB6WT2-60	6 W	6400 K	400 lm	aluminium, aluminium, алюминий, алюміній.	140 g	5902801215858



PL Latarka LED
EN LED Flashlight
RU LED-фонарь
UK Світлодіодний ліхтарик

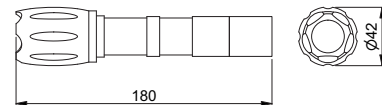
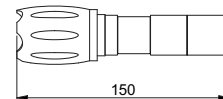

LT-LB8WT6-60	8 W	6400 K	800 lm	aluminium, aluminium, алюминий, алюміній.	135 g	5902801215278



PL Latarka LED
EN LED Flashlight
RU LED-фонарь
UK Світлодіодний ліхтарик

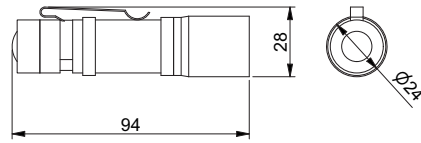

LED
TECHNOLOGY



3 W

S.O.S.
ZOOM



3
years
warranty

Technical & industrial
fixtures



LT-LB3WT4-60	3 W	6400 K	200 lm	aluminium, aluminium, алюминий, алюміній.	40 g	5902801215797



PL Latarka LED
EN LED Flashlight
RU LED-фонарь
UK Світлодіодний ліхтарик

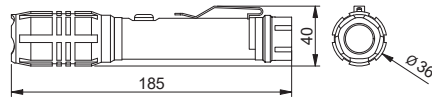

LED
TECHNOLOGY



8 W



Power
Bank

3
years
warranty

LT-LA8WT2-60	8 W	6400 K	800 lm	aluminium, aluminium, алюминий, алюміній.	220 g	5902801215865



PL Latarka LED
 EN LED Flashlight
 RU LED-фонарь
 UK Світлодіодний ліхтарик

Technical & industrial
fixtures



LT-LC6WT3-60	6 W	6400 K	350 lm	aluminium, aluminium, алюминий, алюміній.	175 g	5902801216336

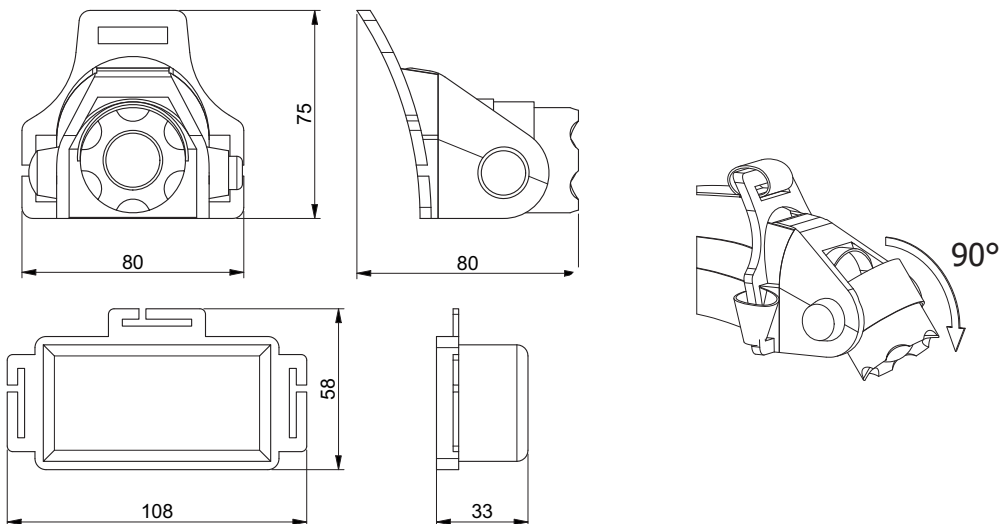







OPRAWY DEKORACYJNE
DECORATIVE FIXTURES
ДЕКОРАТИВНЫЕ СВЕТИЛЬНИКИ
ДЕКОРАТИВНІ СВІТИЛЬНИКИ



Oprawy sufitowe Ceiling fixtures Потолочные светильники Світільники стельові	159
Oprawy punktowe Spotlight fixtures Точечные светильники Точкові світільники	186
Oprawy ogrodowe i elewacyjne Garden and façade light fixtures Садовые и фасадные светильники Садові та фасадні світільники	204
Lampki Desk lamps Настольные лампы Лампи настільні	228



OPRAWY SUFITOWE
CEILING FIXTURES
ПОТОЛОЧНЫЕ СВЕТИЛЬНИКИ
СТЕЛЬОВІ СВІТИЛЬНИКИ

PL Oprawa liniowa LED
EN Linear LED fixture
RU Линейный светильник LED
UK Лінійний світильник LED

OMEGA

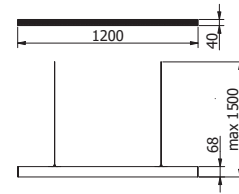
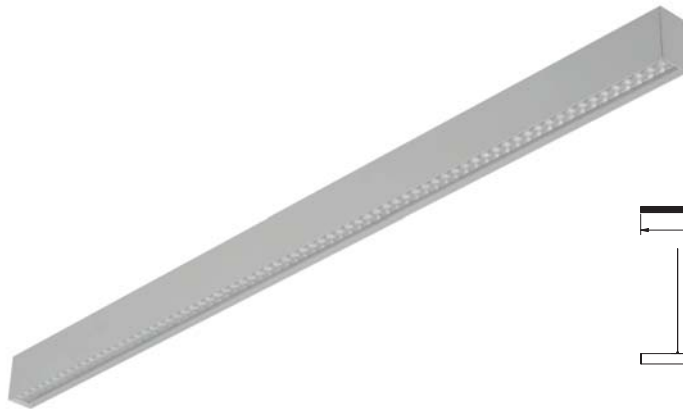

LED



50 W



LD-OME50WNB-10-A	50 W	● 4000 K	4500 lm	biały, white, белый, білий	aluminium + PC aluminum + PC алюминий + PC алюміній + PC	1420 g	5902801245923
LD-OME50WNB-10-C							5902801245992



PL Akcesoria
EN Accessories
RU Аксессуары
UK Аксесуари

OMEGA



LD-OME30WNB-10-L

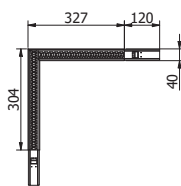

LD-OME30WNB-10-T

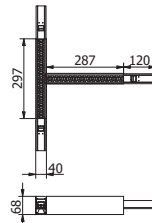

LK-OMEGA-OP

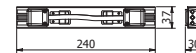

LD-OME30WNB-10-L	30 W	● 4000 K	2700 lm	biały, white, белый, білий	aluminium + PC aluminum + PC алюминий + PC алюміній + PC	940 g	5902801245985
LD-OME30WNB-10-T						1060 g	5902801245831
LK-OMEGA-OP	-	-	-	-	metal, metal, металл, метал	100 g	5902801246012



LED



30 W





PL Oprawa liniowa LED
EN Linear LED fixture
RU Линейный светильник LED
UK Лінійний світильник LED

LED
LED LIGHTING



40 W

3 years
warranty

LUNA



Black

White

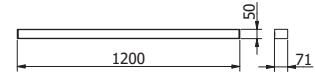

LD-LUN40WNB-10-A	40 W	● 4000 K	3200 lm	biały, white, белый, білий	aluminium + PC aluminium + PC алюминий + PC алюміній + PC	1450 g	5902801245916
LD-LUN40WNB-00-A				czarny, black, черный, чорний			5902801245961



PL Oprawa zwieszana LED
EN LED suspended luminaire
RU Подвесной светильник LED
UK Підвісний світильник LED

LIVIA

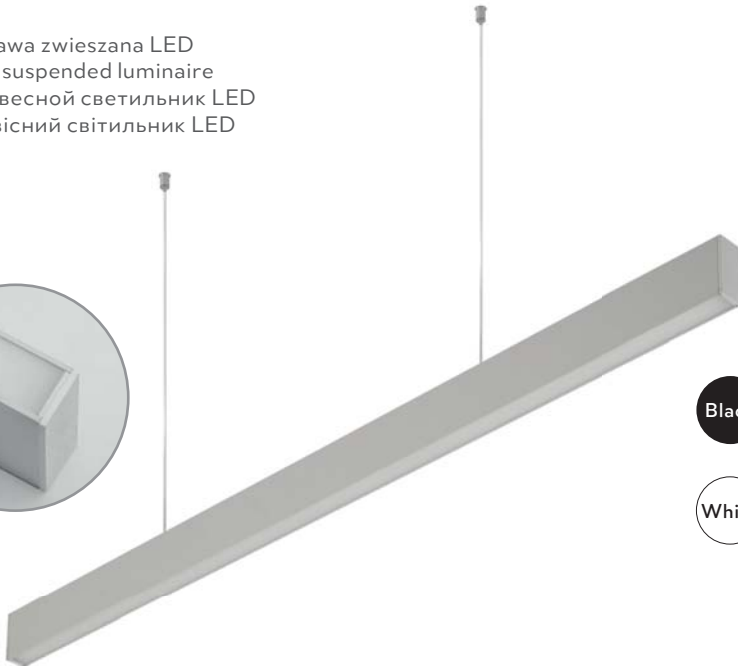

Black

White

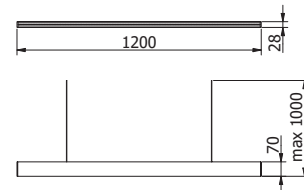

LD-LIV40WNB-10	40 W	● 4000 K	3600 lm	biały, white, белый, білий	aluminium aluminium алюминий алюміній	1300 g	5902801245893
LD-LIV40WNB-00				czarny, black, черный, чорний			5902801243899



LED
LED LIGHTING



40 W

3 years
warranty



PL Oprawa zwieszana LED
EN LED suspended luminaire
RU Подвесной светильник LED
UK Підвісний світильник LED

VILANA

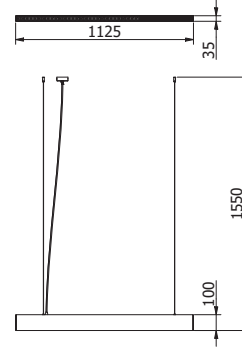
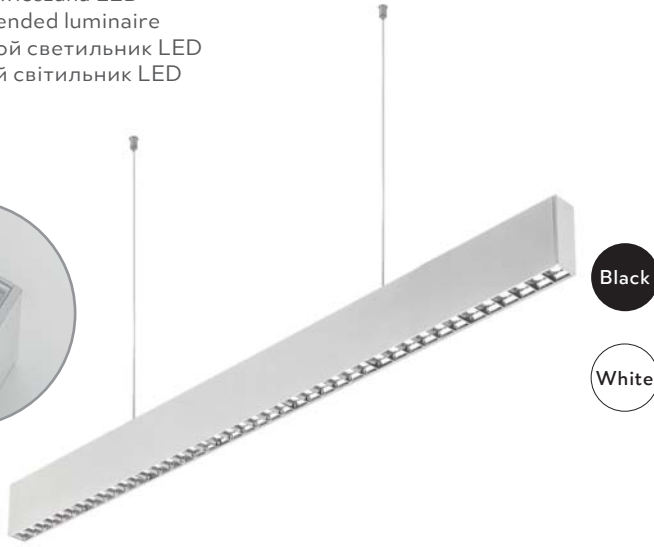

LED
TECHNOLOGY



42 W



12W
30W

5
years
warranty



LD-VIL42WUDB-NB	42 W	● 4000 K	3780 lm	biały, white, белый, білий	aluminium aluminium алюминий алюміній	2100 g	5902801237515
LD-VIL42WUDC-NB				czarny, black, черный, чорний			5902801237546



PL Oprawa zwieszana LED
EN LED suspended luminaire
RU Подвесной светильник LED
UK Підвісний світильник LED

FORTA

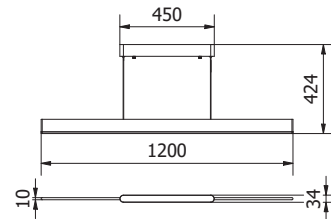

LED
TECHNOLOGY



36 W

3
years
warranty



LD-FRT36WB-NB	36 W	● 4000 K	2900 lm	biały, white, белый, білий	aluminium aluminium алюминий алюміній	3300 g	5902801293313
---------------	------	----------	---------	----------------------------	--	--------	---------------



PL Oprawa LED
EN LED fixture
RU Светодиодный светильник
UK Світлодіодний світильник

LEON



Black

White

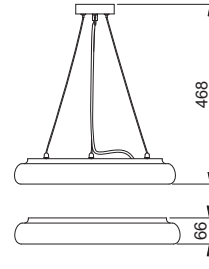
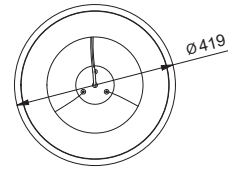

LED
TECHNOLOGIES



35 W

3 years
warranty



LD-LE35WB-NB	35 W	● 4000 K	3200 lm	biały, white, белый, білий	aluminium aluminium алюминий алюміній	2000 g	5902801210693
LD-LE35WC-NB				czarny, black, черный, чорний			5902801210556



PL Oprawa LED
EN LED fixture
RU Светодиодный светильник
UK Світлодіодний світильник

PRIME



Black

White

Grey

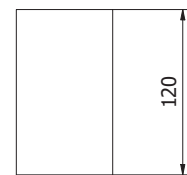
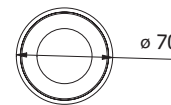

LED
TECHNOLOGIES



10 W

3 years
warranty



LD-PRM10WB-NB	10 W	● 4000 K	1000 lm	biały, white, белый, білий	aluminium aluminium алюминий алюміній	260 g	5902801293344
LD-PRM10WC-NB				czarny, black, черный, чорний			5902801293238
LD-PRM10WS-NB				szary, grey, серый, сірий			5902801293481



PL Oprawa LED
EN LED fixture
RU Светодиодный светильник
UK Світлодіодний світильник



BIANCO



LD-BNC8WKB-NB	8 W	● 4000 K	680 lm	biały, white, белый, білий	320 g	5902801293412
LD-BNC8WKC-NB				czarny, black, черный, чорний		5902801293368



Decorative fixtures

PL Oprawa LED
EN LED fixture
RU Светодиодный светильник
UK Світлодіодний світильник



BIANCO



LD-BNC8WOB-NB	8 W	● 4000 K	680 lm	biały, white, белый, білий	320 g	5902801293351
LD-BNC8WOC-NB				czarny, black, черный, чорний		5902801293450



PL Oprawa sufitowa
EN Ceiling fixture
RU Потолочный светильник
UK Стельовий світильник

TENSA



Black

White

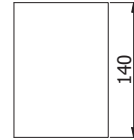
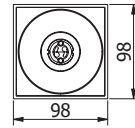

OS-TENGU10KW-10	max 20 W	biały, white, белый, білий	aluminium aluminium алюминий	475 g	5902801274664
OS-TENGU10KW-00		czarny, black, черный, чорний			5902801274763



PL Oprawa sufitowa
EN Ceiling fixture
RU Потолочный светильник
UK Стельовий світильник

TENSA



Black

White

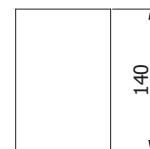
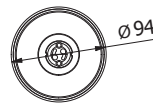

OS-TENGU10-10	max 20 W	biały, white, белый, білий	aluminium aluminium алюминий	425 g	5902801274633
OS-TENGU10-00		czarny, black, черный, чорний			5902801274596



PL Oprawa sufitowa
EN Ceiling fixture
RU Потолочный светильник
UK Стельовий світильник

AERO



Black

White

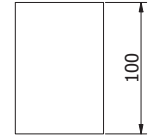
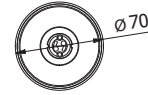

MAX
20 W



OS-AER20W-10	max 2x20 W	biały, white, белый, білий	aluminium aluminium алюминий алюміній	210 g	5902801243752
OS-AER20W-00		czarny, black, черный, чорний			5902801243677



PL Oprawa zwieszana LED
EN LED suspended luminaire
RU Подвесной светильник LED
UK Підвісний світильник LED

LAGOS



Black

White

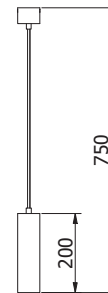

MAX
20 W



OS-LAG20W-10	max 20 W	biały, white, белый, білий	aluminium aluminium алюминий алюміній	400 g	5902801243660
OS-LAG20W-00		czarny, black, черный, чорний			5902801244148



PL Oprawa sufitowa
EN Ceiling fixture
RU Потолочный светильник
UK Стельовий світильник

AVEIRO



Black

White

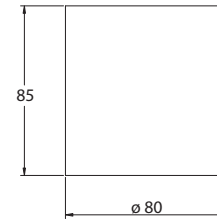
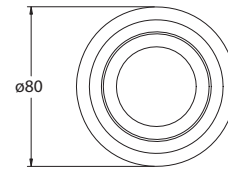

GU10

**MAX
20 W**

3
years
warranty



OS-AV8085OK1-10	max 20 W	biały, white, белый, білий	aluminium aluminium алюминий алюміній	255 g	5902801243783
OS-AV8085OK1-00		czarny, black, черный, чорний			5902801243622



PL Oprawa sufitowa
EN Ceiling fixture
RU Потолочный светильник
UK Стельовий світильник

AVEIRO



Black

White

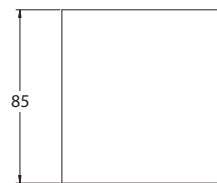
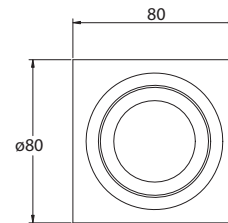

GU10

**MAX
20 W**

3
years
warranty



OS-AV8085KW1-10	max 20 W	biały, white, белый, білий	aluminium aluminium алюминий алюміній	365 g	5902801243646
OS-AV8085KW1-00		czarny, black, черный, чорний			5902801243806



PL Oprawa sufitowa
EN Ceiling fixture
RU Потолочный светильник
UK Стельовий світильник

AVEIRO DUO



Black

White

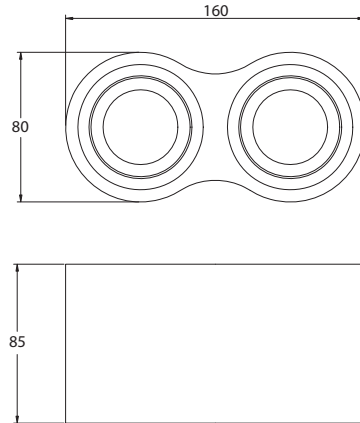

OS-AV80160OK2-10	max 2 x 20 W	biały, white, белый, білий	aluminium aluminium алюминий алюміній	450 g	5902801242830
OS-AV80160OK2-00		czarny, black, черный, чорний			5902801243875



PL Oprawa sufitowa
EN Ceiling fixture
RU Потолочный светильник
UK Стельовий світильник

AVEIRO DUO



Black

White

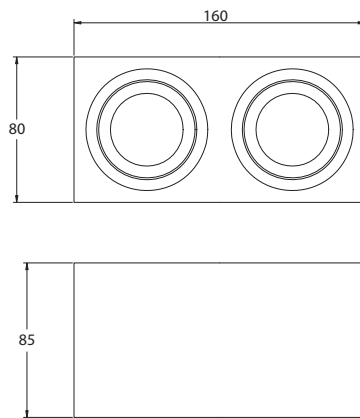

OS-AV80160KW2-10	max 2 x 20 W	biały, white, белый, білий	aluminium aluminium алюминий алюміній	515 g	5902801242748
OS-AV80160KW2-00		czarny, black, черный, чорний			5902801244957







PL Oprawa sufitowa
EN Ceiling light fixture
RU Потолочный светильник
UK Стельовий світильник

Powiązane produkty:
Related products:
Связанные с ними продукты:
Пов'язані продукти:

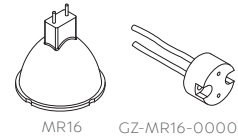

SENSA mini



Black

White



OS-SENM5081OKCZ-00	max 50 W	aluminium, aluminium, алюминий, алюміній	czarny, black, черный, чорний	5901867176769
OS-SENM5081OKB-10			biały, white, белый, білий	5901867176752



Decorative fixtures

PL Oprawa sufitowa
EN Ceiling light fixture
RU Потолочный светильник
UK Стельовий світильник

SENSA mini



Black

White

Powiązane produkty:
Related products:
Связанные с ними продукты:
Пов'язані продукти:

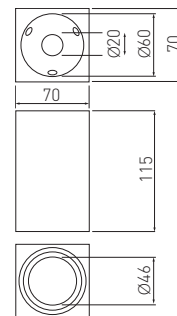
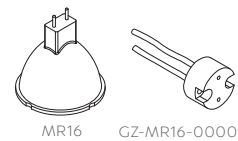

OS-SENM5091KWB-10	max 50 W	aluminium, aluminium, алюминий, алюміній	biały, white, белый, білий	5901867176837
OS-SENM5091KWCZ-00			czarny, black, черный, чорний	5901867176851





PL Oprawa sufitowa
 EN Ceiling light fixture
 RU Потолочный светильник
 UK Стельовий світильник

SENSA



Black

White

Powiązane produkty:
 Related products:
 Связанные с ними продукты:
 Пов'язані продукти::

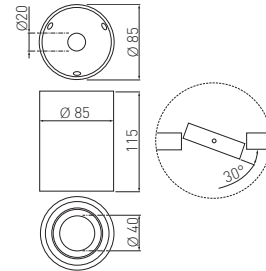
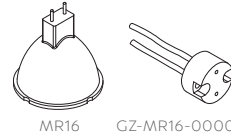

OS-SEN5087OKCZ-00	max 50 W	aluminium, aluminium, алюминий, алюміній	czarny, black, черный, чорний	5901867176813
OS-SEN5087OKB-10			biały, white, белый, білий	5901867176776



PL Oprawa sufitowa
 EN Ceiling light fixture
 RU Потолочный светильник
 UK Стельовий світильник

SENSA

360°



Black

White

Powiązane produkty:
 Related products:
 Связанные с ними продукты:
 Пов'язані продукти::

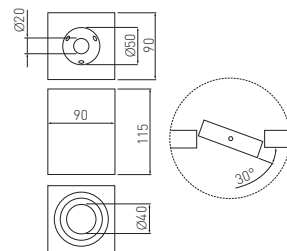
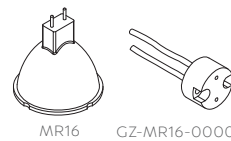

OS-SEN5097KWB-10	max 50 W	aluminium, aluminium, алюминий, алюміній	biały, white, белый, білий	5901867176875
OS-SEN5097KW CZ-00			czarny, black, черный, чорний	5901867176899



PL Oprawa sufitowa
EN Ceiling light fixture
RU Потолочный светильник
UK Стельовий світильник



SENSO DUO

360°



Black

White

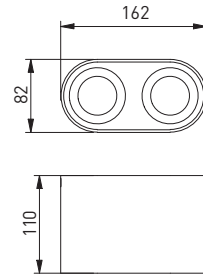

OS-SEND5083OKB-10	max 2 x 50 W	aluminium, aluminium, алюминий, алюміній	biały, white, белый, білий	720 g	5902801129971
OS-SEND5083OKCZ-00			czarny, black, черный, чорний		5902801129933



Decorative fixtures

PL Oprawa sufitowa
EN Ceiling light fixture
RU Плафониера
UK Стельовий світильник



DRAGO

360°



Black

White

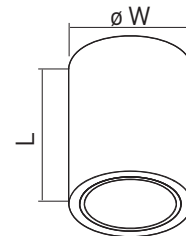

OS-DRAGO14-10	max 60 W	metal metal металл метал	biały, white, белый, білий	148 x ø 133	390 g	5902801230394
OS-DRAGO18-10				180 x ø 172	700 g	5902801230400
OS-DRAGO14-00			czarny, black, черный, чорний	148 x ø 133	390 g	5902801231131
OS-DRAGO18-00				180 x ø 172	700 g	5902801231063





PL Oprawa sufitowa
EN Ceiling light fixture
RU Потолочный светильник
UK Стельовий світильник



BLINK

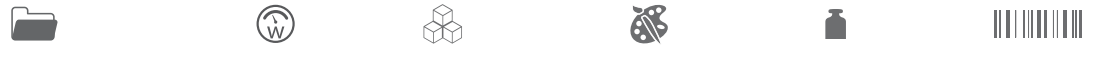
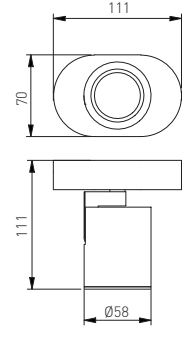

OS-BLN50W1-10	max 20 W	aluminium, aluminium, алюминий, алюміній	biały, white, белый, білий	250 g	5902801240256
OS-BLN50W1-00			czarny, black, черный, чорний		5902801240065



Decorative fixtures



PL Oprawa sufitowa
EN Ceiling light fixture
RU Потолочный светильник
UK Стельовий світильник

BLINK



Black

White

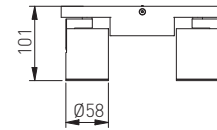
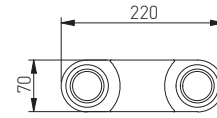

OS-BLN50W2-10	max 2 x 20 W	aluminium, aluminium, алюминий, алюміній	biały, white, белый, білий	490 g	5902801240096
OS-BLN50W2-00			czarny, black, черный, чорний		5902801240263



PL Oprawa sufitowa
EN Ceiling light fixture
RU Потолочный светильник
UK Стельовий світильник

BLINK



Black

White

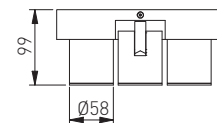
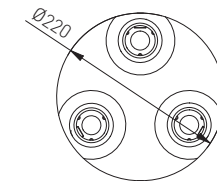

OS-BLN50W3-10	max 3 x 20 W	aluminium, aluminium, алюминий, алюміній	biały, white, белый, білий	920 g	5902801242274
OS-BLN50W3-00			czarny, black, черный, чорний		5902801241888



PL Oprawa sufitowa
EN Ceiling light fixture
RU Потолочный светильник
UK Стельовий світильник

FARGO

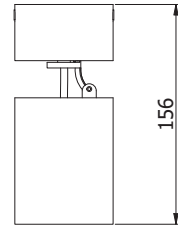
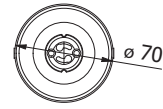

MAX
20 W



OS-FRG20W-10	max 20 W	biały, white, белый, білий	aluminium aluminium алюминий алюміній	280 g	5902801242472
OS-FRG20W-00		czarny, black, черный, чорний			5902801243813



PL Oprawa sufitowa
EN Ceiling light fixture
RU Потолочный светильник
UK Стельовий світильник

FARGO MINI

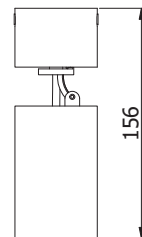
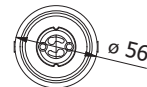

MAX
20 W



OS-FRG20W-10-MINI	max 20 W	biały, white, белый, білий	aluminium aluminium алюминий алюміній	220 g	5902801244100
OS-FRG20W-00-MINI		czarny, black, черный, чорний			5902801243844



PL Oprawa ścienna
EN Wall light fixture
RU Настенный светильник
UK Настінний світильник

SANTO

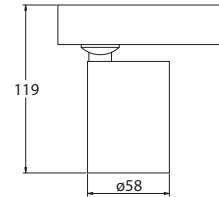
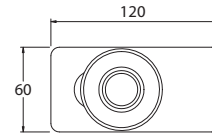

GU10

**MAX
20 W**

3
years
warranty



OS-SAN20WOK1-10	max 20 W	biały, white, белый, білий	aluminium aluminium алюминий алюміній	310 g	5902801244612
OS-SAN20WOK1-00		czarny, black, черный, чорний			5902801244995



PL Oprawa sufitowa
EN Ceiling light fixture
RU Потолочный светильник
UK Стельовий світильник

SANTO

360°

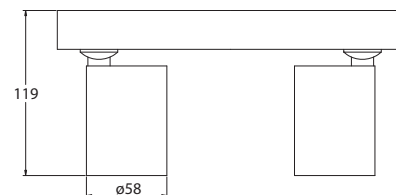
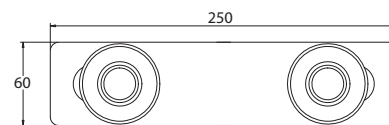

GU10

**MAX
2x20 W**

3
years
warranty



OS-SAN20WOK2-10	max 2 x 20 W	biały, white, белый, білий	aluminium aluminium алюминий алюміній	590 g	5902801244865
OS-SAN20WOK2-00		czarny, black, черный, чорний			5902801244940



PL Oprawa ścienna
EN Wall light fixture
RU Настенный светильник
UK Настінний світильник

RENO

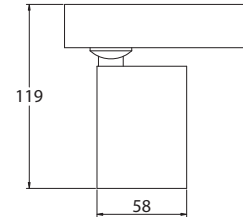
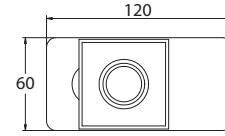

MAX
20 W



Decorative fixtures

OS-REN20WKW1-10	max 20 W	biały, white, белый, білий	aluminium aluminium алюминий алюміній	460 g	5902801244599
OS-REN20WKW1-00		czarny, black, черный, чорний			5902801243974



PL Oprawa sufitowa
EN Ceiling light fixture
RU Потолочный светильник
UK Стельовий світильник

RENO

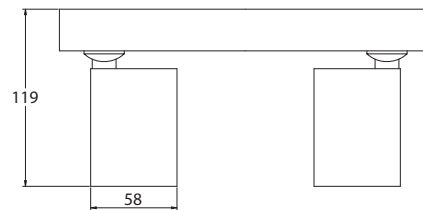
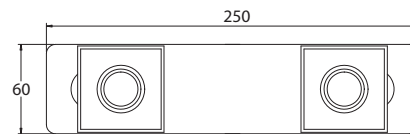

MAX
2x20 W



OS-REN20WKW2-10	max 2 x 20 W	biały, white, белый, білий	aluminium aluminium алюминий алюміній	860 g	5902801244575
OS-REN20WKW2-00		czarny, black, черный, чорний			5902801244636



PL Oprawa sufitowa
EN Ceiling light fixture
RU Потолочный светильник
UK Стельовий світильник

SAKURA



Black

White

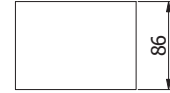
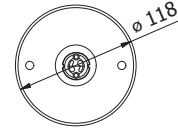

OS-SAKES111-10	max 20 W	biały, white, белый, білий	aluminium aluminium алюминий алюміній	350 g	5902801274350
OS-SAKES111-00		czarny, black, черный, чорний			5902801274565



PL Oprawa sufitowa
EN Ceiling light fixture
RU Потолочный светильник
UK Стельовий світильник

SAKURA

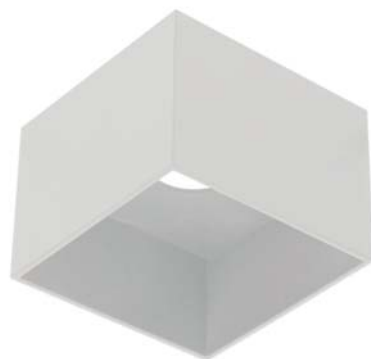

Black

White

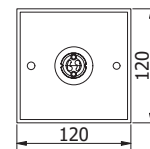

OS-SAKES111KW-10	max 20 W	biały, white, белый, білий	aluminium aluminium алюминий алюміній	500 g	5902801274527
OS-SAKES111KW-00		czarny, black, черный, чорний			5902801274459



PL Oprawa sufitowa natynkowa
EN Surface ceiling fixture
RU Накладной светильник
UK Стельовий світильник поверхневого монтажу



PIREO N



Black

White

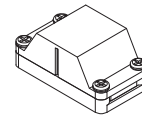
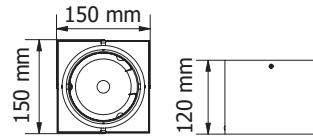

Akcesoria,
Accessories,
Аксессуары,
Аксесуари:
LZ-KOI2KO-10

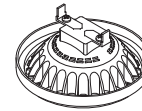

AR111

Powiązane produkty:
Related products:
Связанные с ними продукты:
Пов'язані продукти:.



OP-PIREN1-00	max 50 W	stal steel сталь сталь	biały, white, белый, білий	500 g	5902801248412
OP-PIREN1-20			czarny, black, черный, чорний		5901867191151



PL Oprawa sufitowa natynkowa
EN Surface ceiling fixture
RU Накладной светильник
UK Стельовий світильник поверхневого монтажу



PIREO N



Black

White

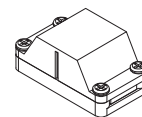
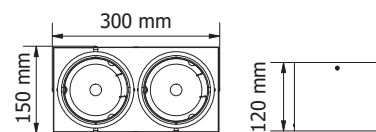

Akcesoria,
Accessories,
Аксессуары,
Аксесуари:
LZ-KOI2KO-10

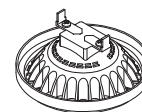

AR111

Powiązane produkty:
Related products:
Связанные с ними продукты:
Пов'язані продукти:.



OP-PIREN2-00	max 2 x 50 W	stal steel сталь сталь	biały, white, белый, білий	900 g	5902801248535
OP-PIREN2-20			czarny, black, черный, чорний		5901867191151



PL Oprawa sufitowa podtynkowa
EN Recessed ceiling fixture
RU Потолочный светильник встраиваемый
UK Стельовий світильник вбудований

PIREO

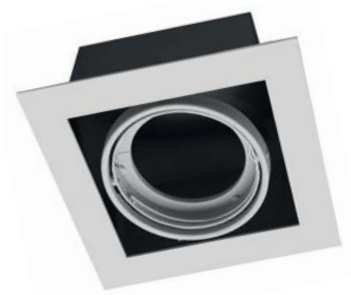

Black

Grey

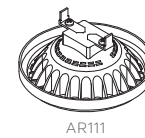
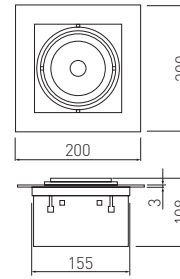

AR111

Powiązane produkty:
Related products:
Связанные с ними продукты:
Пов'язані продукти:



OP-PIREO1-20	max 50 W	stal steel сталь сталь	czarny, black, черный, чорний	500 g	5901867128287
OP-PIREO1-81			szary, grey, серый, сірий		5901867128386



PL Oprawa sufitowa podtynkowa
EN Recessed ceiling fixture
RU Потолочный светильник для скрытой установки
UK Стельовий світильник вбудований

PIREO



Black

Grey

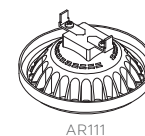
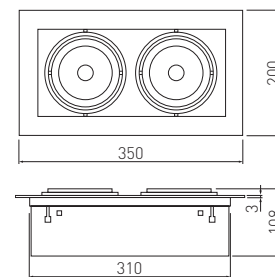

AR111

Powiązane produkty:
Related products:
Связанные с ними продукты:
Пов'язані продукти:



OP-PIREO2-20	max 2 x 50 W	stal steel сталь сталь	czarny, black, черный, чорний	920 g	5901867128300
OP-PIREO2-81			szary, grey, серый, сірий		5901867128409



PL Oprawa ścienna
EN Wall light fixture
RU Настенный светильник
UK Настінний світильник

CAMPIONE



Black

White

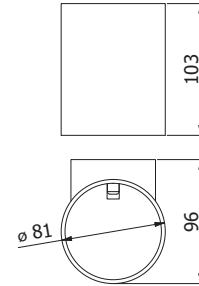

G9

inside

MAX
40 W

3
years
warranty



OS-CAM40WG9OK-10	max 40 W	biały, white, белый, білий	aluminium aluminium алюминий алюміній	255 g	5902801244483
OS-CAM40WG9OK-00		czarny, black, черный, чорний			5902801243868



PL Oprawa ścienna
EN Wall light fixture
RU Настенный светильник
UK Настінний світильник

CAMPIONE



Black

White

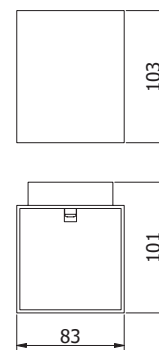

G9

inside

MAX
40 W

3
years
warranty



OS-CAM40WG9KW-10	max 40 W	biały, white, белый, білий	aluminium aluminium алюминий алюміній	280 g	5902801244131
OS-CAM40WG9KW-00		czarny, black, черный, чорний			5902801244506







OPRAWY PUNKTOWE
SPOT LIGHT FIXTURES
ТОЧЕЧНЫЕ СВЕТИЛЬНИКИ
ТОЧКОВІ СВІТИЛЬНИКИ

PL Oprawa sufitowa punktowa
 EN Ceiling spot light fixture
 RU Потолочный точечный светильник
 UK Стельовий точковий світильник

PARMA

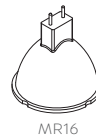

MR16

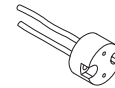

GZ-MR16-0000

Powiązane produkty:
 Related products:
 Связанные с ними продукты:
 Пов'язані продукти:.



OP-PAST1-01	max 50 W	stal steel сталь сталь	chrom, chrome, хром, хром	40 g	5908231384195
OP-PAST1-02			inox, inox, inox, інкс		5908231384232
OP-PAST1-10			biały, white, белый, білий		5908231384171
OP-PAST1-21			czarny chrom, black chrome, черный хром, чорний хром		5908231384188
OP-PAST1-30			patyna, weathered, патина, патина		5908231384201

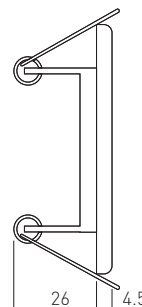
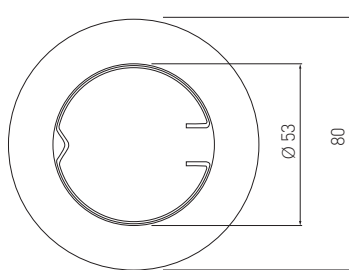

PL Oprawa sufitowa punktowa
EN Ceiling spot light fixture
RU Потолочный точечный светильник
UK Стельовий точковий світильник

PARMA

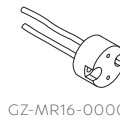
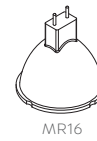

Powiązane produkty:
Related products:
Связанные с ними продукты:
Пов'язані продукти::



OP-PAST2-01	max 50 W	stal, steel, сталь, сталь	chrom, chrome, хром, хром	50 g	5901867101594
OP-PAST2-02			inox, inox, inox, інюкс		5901867101587
OP-PAST2-10			biały, white, белый, білий		5901867101693
OP-PAST2-21			czarny chrom, black chrome, черный хром, чорний хром		5901867101600
OP-PAST2-30			patyna, weathered, патина, патина		5901867101570

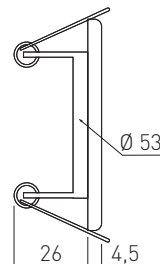
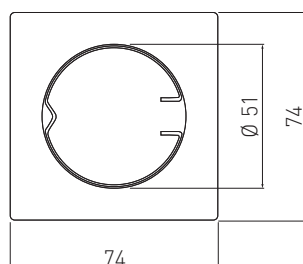

PL Oprawa sufitowa punktowa
 EN Ceiling spot light fixture
 RU Потолочный точечный светильник
 UK Стельовий точковий світильник

PARMA II



OP-PADST1-10

OP-PADST1-01

OP-PADST1-52

OP-PADST1-61

OP-PADST1-21

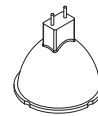

MR16

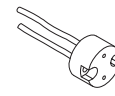

GZ-MR16-0000

Powiązane produkty:
 Related products:
 Связанные с ними продукты:
 Пов'язані продукти::



OP-PADST1-10	max 50 W	stal, steel, сталь, сталь	biały, white, белый, білий	35 g	5908231384195
OP-PADST1-01			chrom, chrome, хром, хром		5908231384232
OP-PADST1-52			satyna, satin, сатин, сатин		5908231384171
OP-PADST1-61			stare złoto, antique gold, старое золото, старе золото		5908231384188
OP-PADST1-21			czarny chrom, black chrome, черный хром, чорний хром		5908231384201

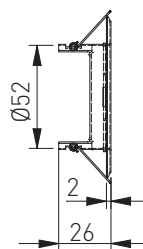
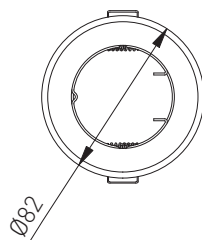

PL Oprawa sufitowa punktowa
 EN Ceiling spot light fixture
 RU Потолочный точечный светильник
 UK Стельовий точковий світильник

PARMA II



OP-PADRK1-10

OP-PADRK1-01

OP-PADRK1-52



OP-PADRK1-61

OP-PADRK1-21

Decorative fixtures

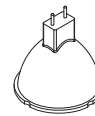

MR16

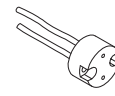

GZ-MR16-0000

Powiązane produkty:
 Related products:
 Связанные с ними продукты:
 Пов'язані продукти::



OP-PADRK1-10	max 50 W	stal, steel, сталь, сталь	biały, white, белый, білий	60 g	5908231384195
OP-PADRK1-01			chrom, chrome, хром, хром		5908231384232
OP-PADRK1-52			satyna, satin, сатин, сатин		5908231384171
OP-PADRK1-61			stare złoto, antique gold, старое золото, старе золото		5908231384188
OP-PADRK1-21			czarny chrom, black chrome, черный хром, чорний хром		5908231384201

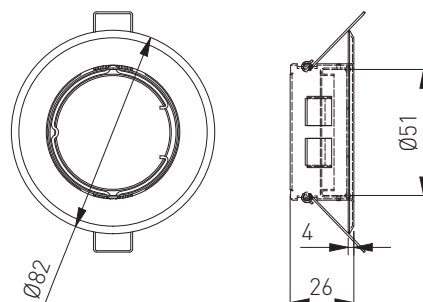

PL Oprawa sufitowa punktowa
 EN Ceiling spot light fixture
 RU Потолочный точечный светильник
 UK Стельовий точковий світильник

PORTO

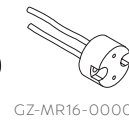
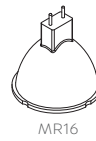

Powiązane produkty:
 Related products:
 Связанные с ними продукты:
 Пов'язані продукти:

OP-PROD3-01	max 50 W	aluminium, aluminium, алюміній, алюміній	chrom, chrome, хром, хром	40 g	5908231384225
OP-PROD3-02			inox, inox, inox, інокс		5908231384249
OP-PROD3-21			czarny chrom, black chrome, черный хром, чорний хром		5908231384256
OP-PROD3-30			patyna, weathered, патина, патина		5908231384263

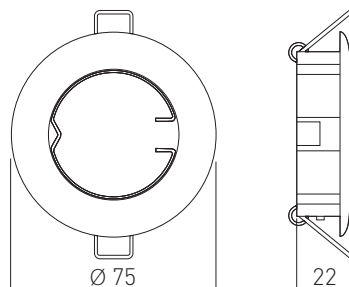

PL Oprawa sufitowa punktowa
 EN Ceiling spot light fixture
 RU Потолочный точечный светильник
 UK Стельовий точковий світильник

PORTO



Decorative fixtures

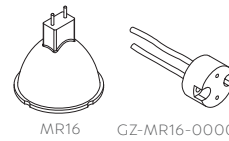

Powiązane produkty:
 Related products:
 Связанные с ними продукты:
 Пов'язані продукти::

OP-PROD4-01	max 50 W	aluminium, aluminium, алюминий, алюміній	chrom, chrome, хром, хром	50 g	5901867101617
OP-PROD4-02			inox, inox, inox, інюкс		5901867101631
OP-PROD4-21			czarny chrom, black chrome, черный хром, чорний хром		5901867101624
OP-PROD4-30			patyna, weathered, патина, патина		5901867101648

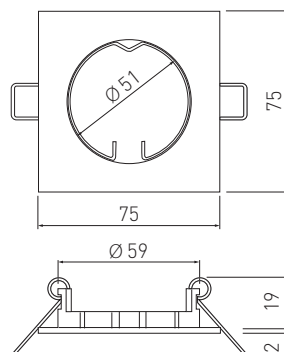

PL Oprawa sufitowa punktowa uchylna
 EN Tilt-down ceiling fixture
 RU Потолочный точечный светильник с изменением наклона
 UK Стельовий точковий світильник поворотний

PORTO K

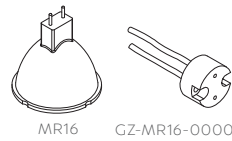

Powiązane produkty:
 Related products:
 Связанные с ними продукты:
 Пов'язані продукти::

OP-PRAN5-01	max 50 W	aluminium, aluminium, алюминий, алюміній	chrom, chrome, хром, хром	80 g	5908231384270
OP-PRAN5-02			inox, inox, inox, інюкс		5908231384287
OP-PRAN5-21			czarny chrom, black chrome, черный хром, чорний хром		5908231384294
OP-PRAN5-30			patyna, weathered, патина, патина		5908231384300

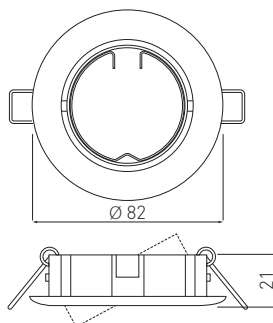

PL Oprawa sufitowa punktowa uchylna
 EN Tilt-down ceiling fixture
 RU Потолочный точечный светильник с изменением наклона
 UK Стельовий точковий світильник поворотний

PORTO K

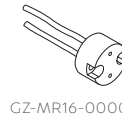
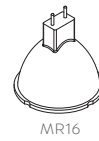

Powiązane produkty:
 Related products:
 Связанные с ними продукты:
 Пов'язані продукти:.



OP-PRAN6-01	max 50 W	aluminium aluminium алюминий алюміній	chrom, chrome, хром, хром	60 g	5901867101655
OP-PRAN6-02			inox, inox, inox, інокс		5901867101686
OP-PRAN6-21			czarny chrom, black chrome, черный хром, чорний хром		5901867101679
OP-PRAN6-30			patyna, weathered, патина, патина		5901867101662

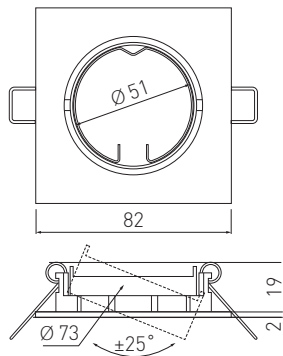



PL Oprawa sufitowa punktowa
EN Ceiling spot light fixture
RU Потолочный точечный светильник
UK Стельовий точковий світильник

Powiązane produkty:
Related products:
Связанные с ними продукты:
Пов'язані продукти:

BRILLANTE



Black

White

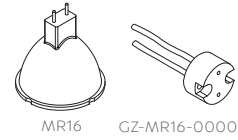

MR16 GZ-MR16-0000

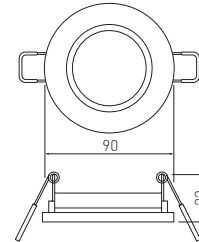

OP-OPROKR-10	max 50 W	szkło, glass, стекло, скло	biały, white, белый, білий	130 g	5901867109699
OP-OPROKR-21			czarny, black, черный, чорний		5901867109705



PL Oprawa sufitowa punktowa
EN Ceiling spot light fixture
RU Потолочный точечный светильник
UK Стельовий точковий світильник

Powiązane produkty:
Related products:
Связанные с ними продукты:
Пов'язані продукти:

BRILLANTE



Black

White

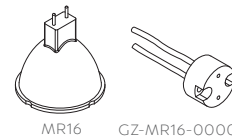

MR16 GZ-MR16-0000

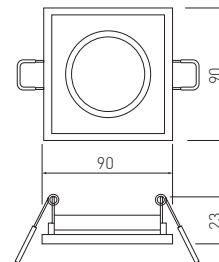

OP-OPRKWT-10	max 50 W	szkło, glass, стекло, скло	biały, white, белый, білий	130 g	5901867109675
OP-OPRKWT-21			czarny, black, черный, чорний		5901867109682





PL Oprawa sufitowa punktowa uchylna
 EN Tilt-down ceiling fixture
 RU Потолочный точечный светильник с изменением наклона
 UK Стельовий точковий світильник поворотний

Powiązane produkty:
 Related products:
 Связанные с ними продукты:
 Пов'язані продукти::

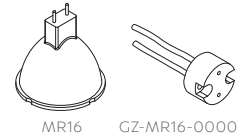

MORENA



Black
 Silver

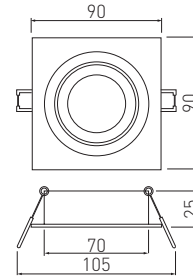

OP-OPRKW1-20	max 50 W	aluminium, aluminium, алюминий, алюміній.	czarny, black, черный, чорний	50 g	5901867127853
OP-OPRKW1-80			srebrny, silver, серебряный, срібний		5901867127839



PL Oprawa sufitowa punktowa uchylna
 EN Tilt-down ceiling fixture
 RU Потолочный точечный светильник с изменением наклона
 UK Стельовий точковий світильник поворотний

Powiązane produkty:
 Related products:
 Связанные с ними продукты:
 Пов'язані продукти::

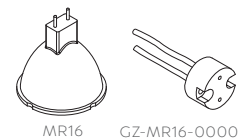

MORENA



Black
 Silver

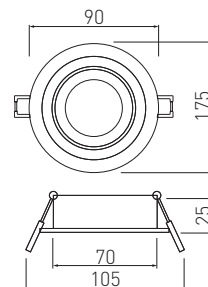

OP-OPROK1-20	max 50 W	aluminium, aluminium, алюминий, алюміній.	czarny, black, черный, чорний	50 g	5901867127815
OP-OPROK1-80			srebrny, silver, серебряный, срібний		5901867127792





PL Oprawa sufitowa punktowa uchylna
 EN Tilt-down ceiling fixture
 RU Потолочный точечный светильник с изменением наклона
 UK Стельовий точковий світильник поворотний

Powiązane produkty:
 Related products:
 Связанные с ними продукты:
 Пов'язані продукти:

SALTO

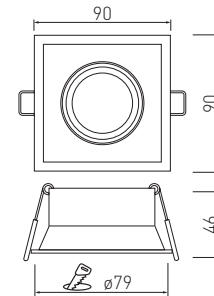
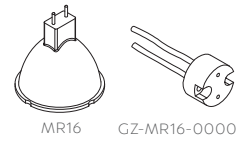

OP-SALKW-10	max 50 W	aluminium, aluminium, алюминий, алюміній.	biały, white, белый, білий	98 g	5901867197580



PL Oprawa sufitowa punktowa uchylna
 EN Tilt-down ceiling fixture
 RU Потолочный точечный светильник с изменением наклона
 UK Стельовий точковий світильник поворотний

Powiązane produkty:
 Related products:
 Связанные с ними продукты:
 Пов'язані продукти:

SALTO

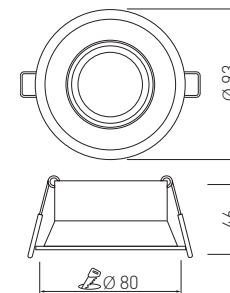
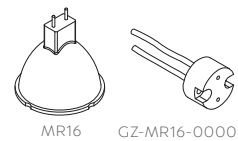

OP-SALOK-10	max 50 W	aluminium, aluminium, алюминий, алюміній	biały, white, белый, білий	98 g	5901867197573



Decorative fixtures





PL Oprawa sufitowa punktowa
EN Ceiling spot light fixture
RU Потолочный точечный светильник
UK Стельовий точковий світильник

Powiązane produkty:
Related products:
Связанные с ними продукты:
Пов'язані продукти:

PALACE II



Black
White

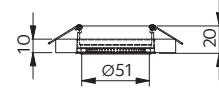
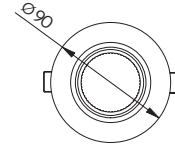
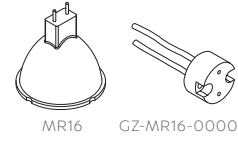

OP-PALACEDOK-10	max 50 W	szkło, glass, стекло, скло	biały, white, белый, білий	125 g	5902801130038
OP-PALACEDOK-20			czarny, black, черный, чорний		5902801130083



PL Oprawa sufitowa punktowa
EN Ceiling spot light fixture
RU Потолочный точечный светильник
UK Стельовий точковий світильник

Powiązane produkty:
Related products:
Связанные с ними продукты:
Пов'язані продукти:

PALACE II



Black
White

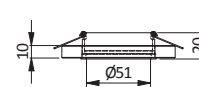
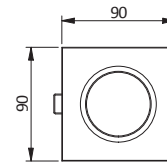
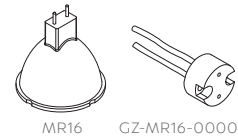

OP-PALACEDKW-10	max 50 W	szkło, glass, стекло, скло	biały, white, белый, білий	165 g	5902801130052
OP-PALACEDKW-20			czarny, black, черный, чорний		5902801130069





PL Oprawa sufitowa punktowa
EN Ceiling spot light fixture
RU Потолочный точечный светильник
UK Стельовий точковий світильник

Powiązane produkty:
Related products:
Связанные с ними продукты:
Пов'язані продукти:

PALACE



OP-PALACEOK-10



OP-PALACEOK-20

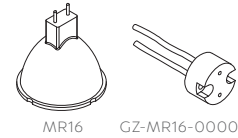

MR16 GZ-MR16-0000

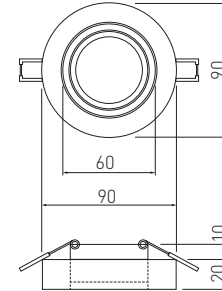

OP-PALACEOK-10	max 50 W	szkło, glass, стекло, скло	biały, white, белый, білий	210 g	5901867128034
OP-PALACEOK-20			czarny, black, черный, чорний		5901867128058



PL Oprawa sufitowa punktowa
EN Ceiling spot light fixture
RU Потолочный точечный светильник
UK Стельовий точковий світильник

Powiązane produkty:
Related products:
Связанные с ними продукты:
Пов'язані продукти:

PALACE



OP-PALACEKW-10

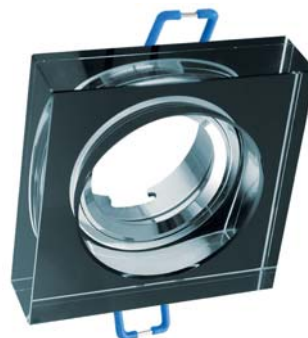

OP-PALACEKW-20

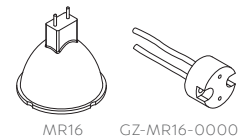

MR16 GZ-MR16-0000

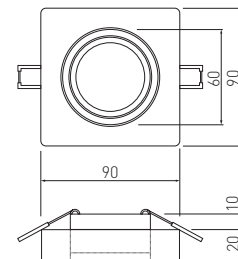

OP-PALACEKW-10	max 50 W	szkło, glass, стекло, скло	biały, white, белый, білий	210 g	5901867128072
OP-PALACEKW-20			czarny, black, черный, чорний		5901867128096



PL Oprawa sufitowa punktowa
EN Ceiling spot light fixture
RU Потолочный точечный светильник
UK Стельовий точковий світильник

ALESSIO



OP-ALSOK-10



OP-ALSOK-52



OP-ALSOK-00

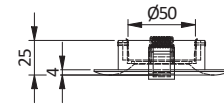
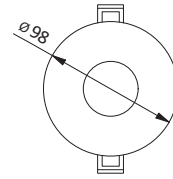

OP-ALSOK-10	max 50 W	aluminium, aluminium, алюминий, алюміній.	biały, white, белый, білий	100 g	5902801242250
OP-ALSOK-00			czarny, black, черный, чорний		5902801242618
OP-ALSOK-52			satyna, satin, сатин, сатин		5902801242687



Decorative fixtures

PL Oprawa sufitowa punktowa
EN Ceiling spot light fixture
RU Потолочный точечный светильник
UK Стельовий точковий світильник

ALESSIO



OP-ALSKW-10



OP-ALSKW-52



OP-ALSKW-00

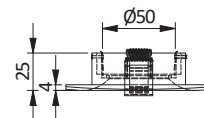
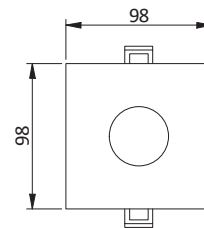

OP-ALSKW-10	max 50 W	aluminium, aluminium, алюминий, алюміній.	biały, white, белый, білий	130 g	5902801243479
OP-ALSKW-00			czarny, black, черный, чорний		5902801242007
OP-ALSKW-52			satyna, satin, сатин, сатин		5902801243585





PL Oprawa sufitowa punktowa
EN Ceiling spot light fixture
RU Потолочный точечный светильник
UK Стельовий точковий світильник

Powiązane produkty:
Related products:
Связанные с ними продукты:
Пов'язані продукти:

AURORA



OP-AUROKB-10



OP-AUROKS-52



OP-AUROKC-00

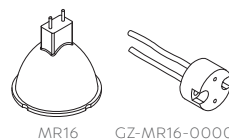

MR16 GZ-MR16-0000

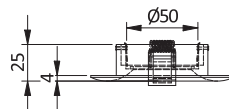
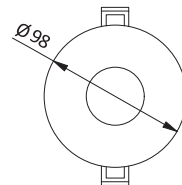

OP-AUROKB-10	max 50 W	aluminium, aluminium, алюминий, алюміній.	biały, white, белый, білий	100 g	5902801238819
OP-AUROKS-52			satyna, satin, сатин, сатин		5902801239731
OP-AUROKC-00			czarny, black, черный, чорний		5902801267895



PL Oprawa sufitowa punktowa
EN Ceiling spot light fixture
RU Потолочный точечный светильник
UK Стельовий точковий світильник

Powiązane produkty:
Related products:
Связанные с ними продукты:
Пов'язані продукти:

AURORA



OP-AURKWB-10



OP-AURKWS-52



OP-AURKWC-00

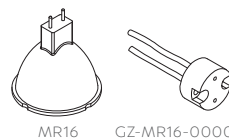

MR16 GZ-MR16-0000

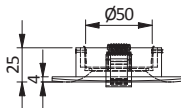
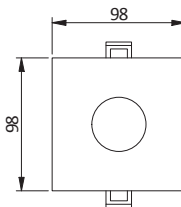

OP-AURKWB-10	max 50 W	aluminium, aluminium, алюминий, алюміній.	biały, white, белый, білий	130 g	5902801239991
OP-AURKWS-52			satyna, satin, сатин, сатин		5902801240034
OP-AURKWC-00			czarny, black, черный, чорний		5902801267901



PL Oprawa schodowa LED
 EN Staircase LED fixture
 RU Лестничный светодиодный светильник
 UK Світильник для сходів

LED
 TECHNOLOGY
 inside
 0,8 W

3 years
 warranty

ESCADA

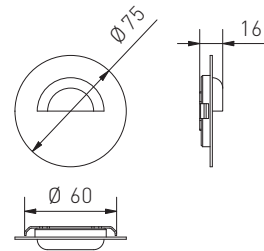

LD-ESOA084-51	0,8 W	● 4000 K	70 lm	inox, inox, шлифованная сталь, інокс.	5902801211119
---------------	-------	----------	-------	---	---------------



Decorative fixtures

PL Oprawa schodowa LED
 EN Staircase LED fixture
 RU Лестничный светодиодный светильник
 UK Світильник для сходів

LED
 TECHNOLOGY
 inside
 0,8 W

3 years
 warranty

ESCADA

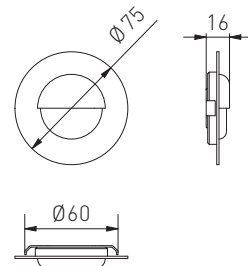

LD-ESOB084-51	0,8 W	● 4000 K	70 lm	inox, inox, шлифованная сталь, інокс.	5902801210990
---------------	-------	----------	-------	---	---------------



PL Oprawa schodowa LED
 EN Staircase LED fixture
 RU Лестничный светодиодный светильник
 UK Світильник для сходів

LED
 inside
 0,8 W
 3 years warranty

ESCADA

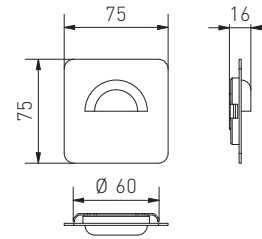
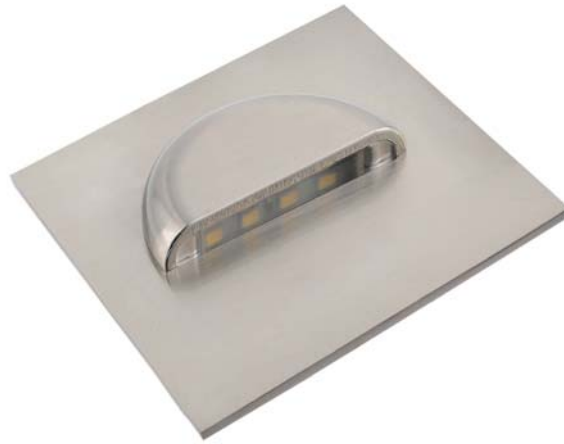

LD-ESKA084-51	0,8 W	● 4000 K	70 lm	inox, inox, шлифованная сталь, інокс.	5902801211270

PL Oprawa schodowa LED
 EN Staircase LED fixture
 RU Лестничный светодиодный светильник
 UK Світильник для сходів

ESCADA

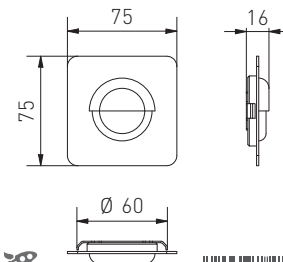

LED
 inside
 0,8 W
 3 years warranty

LD-ESKB084-51	0,8 W	● 4000 K	70 lm	inox, inox, шлифованная сталь, інокс.	5902801211201

Decorative fixtures



OPRAWY OGRODOWE I ELEWACYJNE
GARDEN AND WALL FIXTURES
САДОВЫЕ И ФАСАДНЫЕ СВЕТИЛЬНИКИ
САДОВІ ТА ФАСАДНІ СВІТИЛЬНИКИ

PL Oprawa elewacyjna
EN Façade fixture
RU Фасадный светильник
UK Фасадний світильник

MILAN



OS-MILA00A-00



OS-MILA00U-00

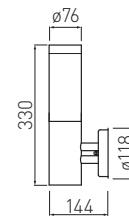

OS-MILA00A-00



OS-MILA00U-00



OS-MILA00A-00	max 40 W	stal nierdzewna + PC; stainless steel + PC; нержавеющая сталь + ПК; нержавіюча сталь + PC	inox, inox, інох, інокс	502 g	5901867199218
OS-MILA00U-00				358 g	5901867199195



PL Oprawa ogrodowa
EN Garden luminaire
RU Садовый светильник
UK Садовий світильник

MILAN



OS-MILA45P-00



OS-MILA10P-00

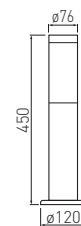

OS-MILA45P-00

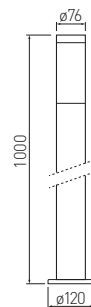

OS-MILA10P-00



OS-MILA10P-00	max 40 W	stal nierdzewna + PC; stainless steel + PC; нержавеющая сталь + ПК; нержавіюча сталь + PC	inox, inox, інох, інокс	876 g	5901867199256
OS-MILA45P-00				463 g	5901867199232





PL Oprawa elewacyjna
EN Façade fixture
RU Фасадный светильник
UK Фасадний світильник

GRANDE

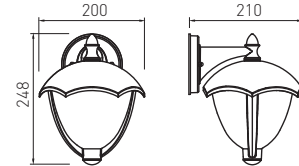

OS-GRA0DA-00	max 60 W	aluminium + PC; aluminium + PC; алюминий + PC; алюміній + PC	czarny, black, черный, чорний	627 g	5901867199133



Decorative fixtures

PL Oprawa elewacyjna
EN Façade fixture
RU Фасадный светильник
UK Фасадний світильник



GRANDE

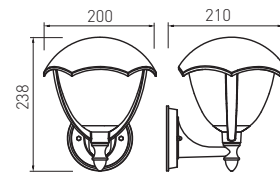

OS-GRA0UA-00	max 60 W	aluminium + PC; aluminium + PC; алюминий + PC; алюміній + PC	czarny, black, черный, чорний	627 g	5901867199157





PL Oprawa ogrodowa
EN Garden luminaire
RU Садовый светильник
UK Садовий світильник

GRANDE



Decorative fixtures

OS-GRA00P-00	max 60 W	aluminium + PC; aluminium + PC; алюминий + PC; алюміній + PC	czarny, black, черный, чорний	1020 g	5901867199119

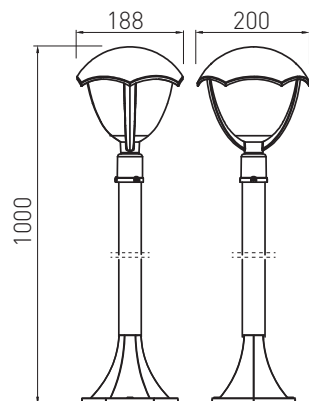



PL Oprawa elewacyjna
EN Façade fixture
RU Фасадный светильник
UK Фасадний світильник

TOSKANA

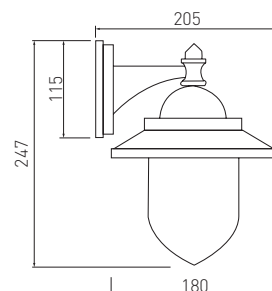

Decorative fixtures

OS-TOS0DA-00	max 60 W	aluminium + PC; aluminium + PC; алюминий + PC; алюміній + PC	627 g	5901867199171



PL Oprawa elewacyjna
EN Façade fixture
RU Фасадный светильник
UK Фасадний світильник



ASTRIT



Grey

Black

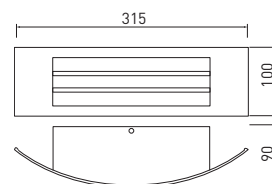

OS-ASTRITE27-20	max 14 W	tworzywo, plastic, пластмасса, пластик	czarny, black, черный, чорний	450 g	5901867190826
OS-ASTRITE27-80			szary, grey, серый, сірий	450 g	5901867190802





PL Oprawa elewacyjna
EN Façade fixture
RU Фасадный светильник
UK Фасадний світильник

MARINA

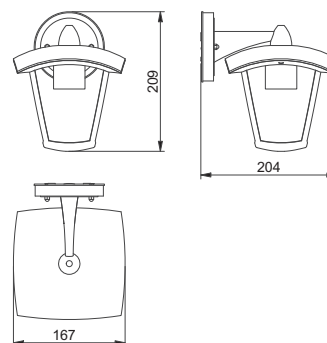

Decorative fixtures

OS-MARINADA-00	max 20 W	aluminium + PC; aluminium + PC; алюминий + PC; алюміній + PC	czarny, black, черный, чорний	750 g	5902801205583



PL Oprawa elewacyjna
EN Façade fixture
RU Фасадный светильник
UK Фасадний світильник

MARINA

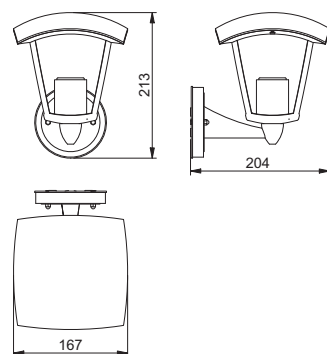

OS-MARINAUA-00	max 20 W	aluminium + PC; aluminium + PC; алюминий + PC; алюміній + PC	czarny, black, черный, чорний	750 g	5902801205637



PL Oprawa ogrodowa
EN Garden luminaire
RU Садовый светильник
UK Садовий світильник

MARINA

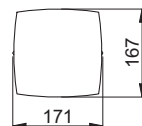
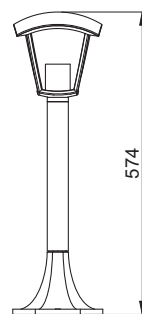

OS-MARINAP-00	max 20 W	aluminium + PC; aluminium + PC; алюминий + PC;	czarny, black, черный, чорний	750 g	5902801205798



PL Oprawa ogrodowa
EN Garden luminaire
RU Садовый светильник
UK Садовий світильник

MARINA



OS-MARINAP3-00



OS-TMG30CM-00

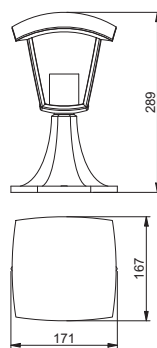

OS-MARINAP3-00



OS-TMG30CM-00



OS-MARINAP3-00	max 20 W	aluminium + PC; aluminium + PC; алюминий + PC;	czarny, black, черный, чорний	750 g	5902801205804
OS-TMG30CM-00				500 g	5902801224645



PL Oprawa elewacyjna
EN Façade fixture
RU Фасадный светильник
UK Фасадний світильник

MARINA

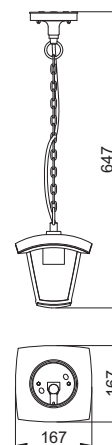

OS-MARINAH-00	max 20 W	aluminium + szkło; aluminium + glass; алюминий + стекло; алюміній + скло.	czarny, black, черный, чорний	750 g	5902801205743
---------------	----------	--	--	-------	---------------



PL Oprawa elewacyjna
EN Façade fixture
RU Фасадный светильник
UK Фасадний світильник

VENTANA



OS-MARINAP3-00



OS-TMG30CM-00

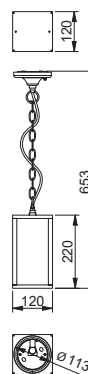

OS-MARINAP3-00

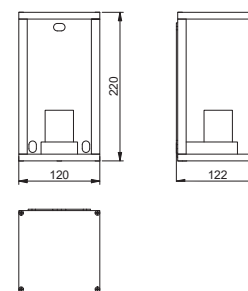

OS-TMG30CM-00



OS-VENTANAH-00	max 20 W	aluminium + szkło; aluminium + glass; алюминий + стекло; алюміній + скло.	czarny, black, черный, чорний	1312g	5902801225055
OS-VENTANAUA-00				1140g	5902801282423





PL Oprawa elewacyjna
EN Façade fixture
RU Фасадный светильник
UK Фасадний світильник



VALLA

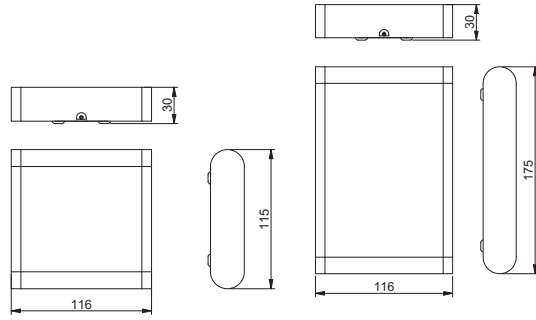

LD-VALLA8W-40

LD-VALLA12W-40



LD-VALLA8W-40	8 W	aluminium + szkło; aluminium + glass; алюминий + стекло; алюміній + скло.	czarny, black, черный, чорний	359 g	5902801205613
LD-VALLA12W-40	12 W			555 g	5902801203299

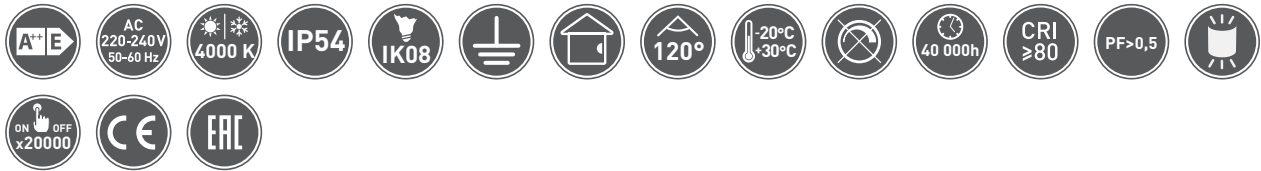

Decorative fixtures

PL Oprawa elewacyjna
EN Façade fixture
RU Фасадный светильник
UK Фасадний світильник

PARIS



Black

White

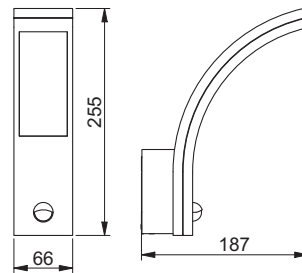

LD-PAR10W40-00	PC	biały, white, белый, білий	450	5902801282065
LD-PAR10W40-10		czarny, black, черный, чорний		5902801282072





PL Oprawa elewacyjna
EN Façade fixture
RU Фасадный светильник
UK Фасадний світильник



NESSA



Grey

Black

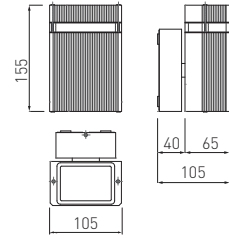

INFO



LD-NESSAGU10J-80	max 50 W	stop aluminium + szkło hartowane, aluminium alloy + tempered glass, сплав алюминия + закаленное стекло, алюміній + гартоване скло.	szary, grey, серый, сірий	jednokierunkowa, unidirectional, однонаправленный, одностороння	850 g	5901867122230
LD-NESSAGU10J-20			czarny, black, черный, чорний			5901867122254



PL Oprawa elewacyjna
EN Façade fixture
RU Фасадный светильник
UK Фасадний світильник



NESSA



Grey

Black

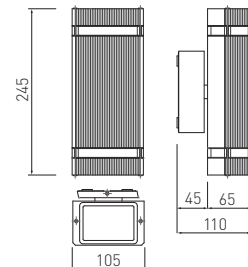

INFO



LD-NESSAGU10D-80	max 2 x 50 W	stop aluminium + szkło hartowane, aluminium alloy + tempered glass, сплав алюминия + закаленное стекло, алюміній + гартоване скло.	szary, grey, серый, сірий	dwukierunkowa, bidirectional, двунаправленный, двостороння	1100 g	5901867122193
LD-NESSAGU10D-20			czarny, black, черный, чорний			5901867122216



PL Oprawa elewacyjna
EN Façade fixture
RU Фасадный светильник
UK Фасадний світильник

SILVA



Grey

Black

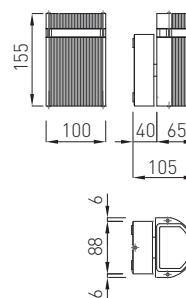

				INFO		
LD-SILVAGU10J-80	max 50 W	stop aluminium + szkło hartowane, aluminium alloy + tempered glass, сплав алюминия + закаленное стекло, алюміній + гартоване скло.	szary, grey, серый, сірий	jednokierunkowa, unidirectional, односторонний, одностороння	800 g	5901867122117
LD-SILVAGU10J-20			czarny, black, черный, чорний			5901867122131



PL Oprawa elewacyjna
EN Façade fixture
RU Фасадный светильник
UK Фасадний світильник

SILVA



Grey

Black

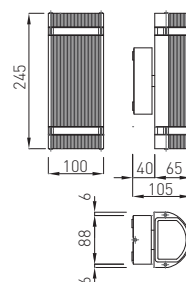

				INFO		
LD-SILVAGU10D-80	max 2 x 50 W	stop aluminium + szkło hartowane, aluminium alloy + tempered glass, сплав алюминия + закаленное стекло, алюміній + гартоване скло.	szary, grey, серый, сірий	dwukierunkowa, bidirectional, двусторонний, двустороння	1100 g	5901867122155
LD-SILVAGU10D-20			czarny, black, черный, чорний			5901867122179



PL Oprawa elewacyjna
EN Façade fixture
RU Фасадный светильник
UK Фасадний світильник

TIAGO



Inox

Black

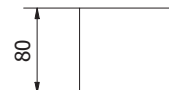
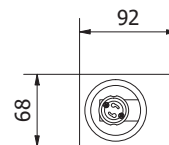

LD-TIAGOGU10J-20KW	max 35 W	aluminium + szkło hartowane, aluminium + tempered glass, алюминий + закаленное стекло, алюміній + гартоване скло.	czarny, black, черный, чорний	275g	5902801211102
LD-TIAGOGU10D-20KW			inox, brushed steel, шлифованная сталь, inox.		5902801203305



PL Oprawa elewacyjna
EN Façade fixture
RU Фасадный светильник
UK Фасадний світильник

TIAGO



Inox

Black

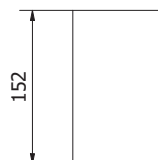
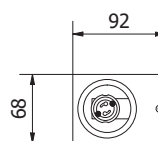

LD-TIAGOGU10J-01KW	2 x max 35 W	aluminium + szkło hartowane, aluminium + tempered glass, алюминий + закаленное стекло, алюміній + гартоване скло.	czarny, black, черный, чорний	668g	5902801212352
LD-TIAGOGU10D-01KW			inox, brushed steel, inox		5902801203329





PL Oprawa elewacyjna
EN Façade fixture
RU Фасадный светильник
UK Фасадний світильник

TIAGO



Inox

Black

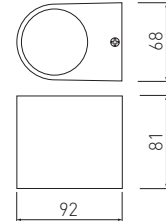

INFO



LD-TIAGOGU10J-20	1 x max 35 W	stop aluminium + szkło hartowane, aluminium alloy + tempered glass, сплав алюминия + закаленное стекло, алюміній + гартоване скло.	czarny, black, черный, чорний	jednokierunkowa, unidirectional, однонаправленный, одностороння	300 g	5901867162144
LD-TIAGOGU10J-01			inox, inox, inox, інокс			5902801255984



PL Oprawa elewacyjna
EN Façade fixture
RU Фасадный светильник
UK Фасадний світильник

TIAGO



Inox

Black

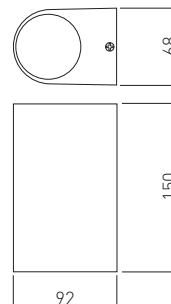

INFO



LD-TIAGOGU10D-20	2 x max 35 W	stop aluminium + szkło hartowane, aluminium alloy + tempered glass, сплав алюминия + закаленное стекло, алюміній + гартоване скло.	czarny, black, черный, чорний	dwukierunkowa, bidirectional, двунаправленный, двостороння	470 g	5901867162151
LD-TIAGOGU10D-01			inox, inox, inox, інокс			5902801256042



PL Oprawa elewacyjna
EN Façade fixture
RU Фасадный светильник
UK Фасадний світильник

BALEO



LD-BA2E27-00



LD-BA2GU10-0M

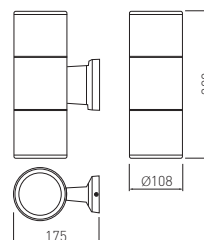

LD-BA2E27-00

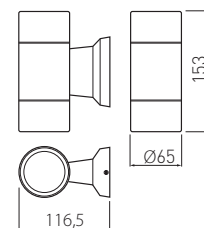

LD-BA2GU10-0M



INFO



LD-BA2E27-00	2 x max 40 W	E27	stop aluminium + szkło hartowane, aluminium alloy + tempered glass, сплав алюминия + закаленное стекло, алюміній + гартоване скло.	szary, grey, серый, сірий	dwukierunkowa, bidirectional, двунаправленный, двостороння	900 g	5901867136930
LD-BA2GU10-0M	2 x max 10 W	GU10				400 g	5901867136893



PL Oprawa elewacyjna
EN Façade fixture
RU Фасадный светильник
UK Фасадний світильник

BALEO



LD-BALE27-00



LD-BALGU10-0S

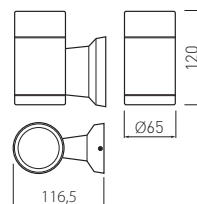

LD-BALE27-00

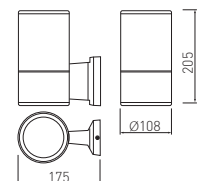

LD-BALGU10-0S



INFO



LD-BALGU10-0S	1 x max 10 W	GU10	stop aluminium + szkło hartowane, aluminium alloy + tempered glass, сплав алюминия + закаленное стекло, алюміній + гартоване скло.	szary, grey, серый, сірий	jednokierunkowa, unidirectional, однонаправленный, одностороння	300 g	5901867136879
LD-BALE27-00	1 x max 40 W	E27				600 g	5901867136916





GIRLANDA



Decorative fixtures



AE-GR610-10	max. 10 x 10W	tworzywo, plastic, пластмасса, пластик	czarny, black, черный, чорний	1812 g	5902801281242
-------------	---------------	---	--	--------	---------------

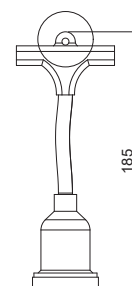
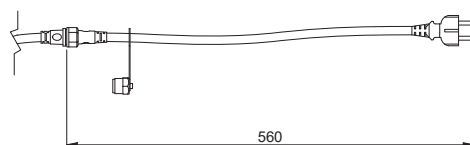
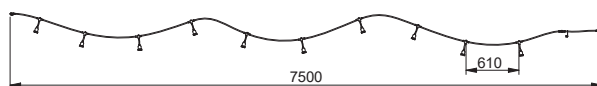



PL Oprawa ogrodowa
EN Garden luminaire
RU Садовый светильник
UK Садовий світильник

DIEGO



Grey

Black

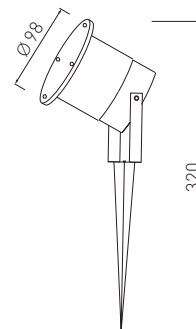

OS-DIEGOGU10-20	max 35 W	aluminium, aluminium, алюминий, алюміній	czarny, black, черный, чорний	330 g	5901867185716
OS-DIEGOGU10-80			szary, grey, серый, сірий		5902801256493



PL Oprawa ogrodowa
EN Garden luminaire
RU Садовый светильник
UK Садовий світильник

MARMO

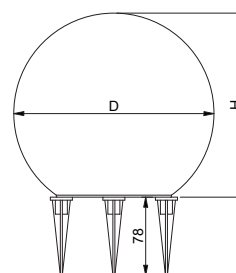

OS-MARMO25-00	max 35 W	PE	ø 250 x 230	812 g	5902801211294
OS-MARMO28-00			ø 280 x 250	950 g	5902801224706
OS-MARMO38-00			ø 380 x 350	1700 g	5902801224683





PL Oprawa dogruntowa
EN In-ground light fixture
RU Тротуарно-наездной светильник
UK Ґрунтовий світильник

ALFA



ON-ALFAOGU10-06



ON-ALFAKGU10-06

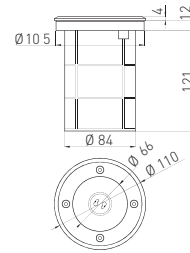

ON-ALFAOGU10-06

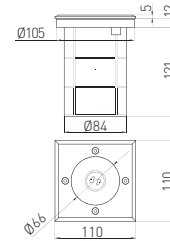

ON-ALFAKGU10-06



ON-ALFAOGU10-06	max 50 W	pierścień - stal nierdzewna, korpus - aluminium, puszka montażowa - PC, ring - stainless steel, body - aluminum, assembly box - PC, кольцо - нержавеющей сталь, корпус - алюминий, монтажная чашка - поликарбонат, кільце - нержавіюча сталь, корпус - алюміній, кріпильна коробка - PC	500 g	5901867109934
ON-ALFAKGU10-06			700 g	5901867109958



PL Oprawa wbudowana podłogowa
EN Recessed floor light fixture
RU Напольный встраиваемый светильник
UK Підлоговий вбудований світильник

ALFA MINI

360°



ON-ALFAOGU10-06



ON-ALFAKGU10-06

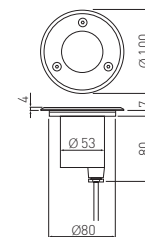

ON-ALFAOGU10-06

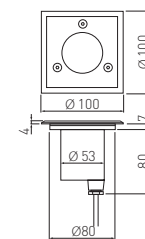

ON-ALFAKGU10-06



ON-ALFAOGU10-06-MINI	max 10 W	pierścień - stal nierdzewna; obudowa - aluminium, ring - stainless steel; enclosure - aluminium, кольцо - нержавеющей сталь; корпус - алюминий, кільце - нержавіюча сталь; корпус - алюміній,	370 g	5901867119889
ON-ALFAKGU10-06-MINI				5901867119896



- PL Pokrywka jednokierunkowa i dwukierunkowa do oprawy najazdowej
- EN Unidirectional & bidirectional diffuser shroud for in-ground light fixtures
- RU Крышка однонаправленная и двунаправленная для наездного светильника
- UK Одностороння і двостороння кришка для тротуарного світильника

ALFA-O



ON-ALFAO-C1W



ON-ALFAO-C2W



INFO



ON-ALFAO-C1W	ON-ALFAOGU10-06	pokrywka jednokierunkowa, unidirectional diffuser shroud, однонаправленная крышка дифузор односторонний	stal nierdzewna, stainless steel,	5901867122360
ON-ALFAO-C2W	ON-ALFAKGU10-06	pokrywka dwukierunkowa, bidirectional diffuser shroud, двунаправленная крышка, дифузор двосторонний	нержавеющая сталь, нержавіюча сталь	5901867122384





LAMPKI
DESK LAMPS
НАСТОЛЬНЫЕ ЛАМПЫ
ЛАМПИ НАСТІЛЬНІ

PL Lampka biurkowa LED
EN Desktop LED lamp
RU Настольная светодиодная лампа
UK Настільна світлодіодна лампа

GALACTIC LED

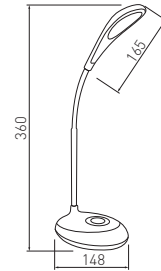

LB-GAL3WRU-10	3 W	120 lm	● 4000 K	tworzywo, plastic, пластмасса, пластик	biały, white, белый, білий	314 g	5902801010392



PL Lampka biurkowa LED
EN Desktop LED lamp
RU Настольная светодиодная лампа
UK Настільна світлодіодна лампа

GALACTIC LED

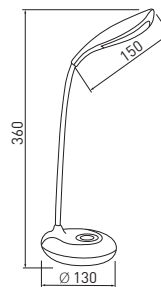

LB-GAL5WRU-10	5 W	240 lm	● 4000 K	tworzywo, plastic, пластмасса, пластик	biały, white, белый, білий	554 g	5902801010408



Decorative fixtures

PL Lampka biurkowa LED
EN Desktop LED lamp
RU Настольная светодиодная лампа
UK Настільна світлодіодна лампа

GALACTIC LED

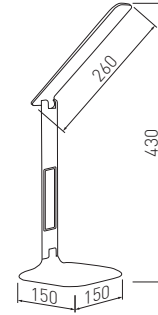

LB-GAL5WM0-10	5 W	240 lm	<ul style="list-style-type: none"> ● 3000 K ● 4000 K ● 6400 K 	tworzywo, plastic, пластмасса, пластик	biały, white, белый, білий	732 g	5902801010514
---------------	-----	--------	--	--	----------------------------	-------	---------------



PL Lampa podłogowa
EN Floor lamp
RU Торшер
UK Підлогова лампа

BENFICA 2

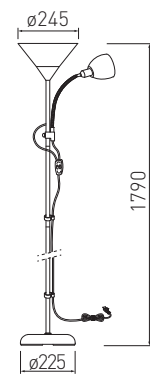

LP-BENFICA2-80	E27 - max 60 W E14 - max 40 W	tworzywo + metal, plastic + metal, пластик + металл, пластик + метал	szary, grey, серый, сірий	3000 g	5908231398123
LP-BENFICA2-00			czarny, black, черный, чорний		5902801298233
LP-BENFICA2-10			biały, white, белый, білий		5902801297809









SYSTEMY SZYNOWE
TRACK SYSTEMS
ТРЕКОВЫЕ СИСТЕМЫ ОСВЕЩЕНИЯ
ТРЕКОВІ СИСТЕМИ ОСВІТЛЕННЯ

Reflektory LED	
Spot lights LED	
Светодиодные лампы	
Світлодіодні трекові світильники	235
Szynoprzewody	
Track systems	
Шинопровод	
Шинопровід	240





REFLEKTORY LED
LED TRACK LIGHT FIXTURES
СВЕТОДИОДНЫЕ ТРЕКОВЫЕ СВЕТИЛЬНИКИ
СВІТЛОДІОДНІ ТРЕКОВІ СВІТИЛЬНИКИ

360°



XLD-Z3OP20SZ1-00	MAX 3x20 W	biały, white, белый, білий	aluminium aluminium алюміній алюміній	1100 g	5902801285042
XLD-Z3OP20SZ1-10		czarny, black, черный, чорний			5902801241772

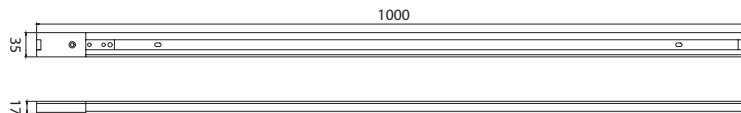
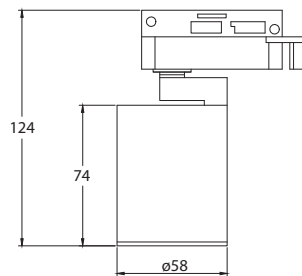
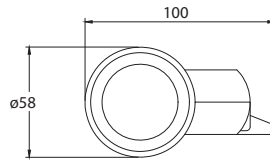

PL Reflektor LED ZOOM Line
 EN ZOOM Line LED track light fixture
 RU Светодиодный трековый светильник ZOOM Line
 UK Світлодіодний трековий світильник ZOOM Line

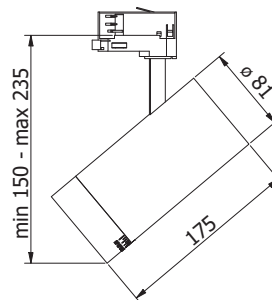

ZLD-30W1538ZLN-NB0	30 W	4000 K	3000 lm	biały, white, белый, білий	aluminium aluminium алюминий алюміній	15-38°	940 g	5902801237522		
ZLD-30W1538ZLN-NB1				czarny, black, черный, чорний				5902801245374		



PL Reflektor LED do szynoprzewodu, ze zmiennym kątem światła
 EN LED track light fixture with adjustable beam angle
 RU Трековый светодиодный светильник, с изменяемым углом освещения
 UK Трековий світлодіодний світильник, із змінним кутом освітлення

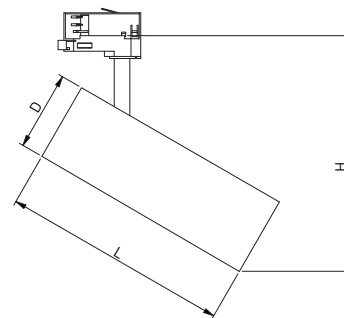

	L	D	H min	H max
TLD-12W38LN-NB0	155	ø 55	130	210
TLD-12W38LN-NB1				
TLD-20W38LN-NB0	185	ø 66	145	230
TLD-20W38LN-NB1				
TLD-30W38LN-NB0	220	ø 77	153	270
TLD-30W38LN-NB1				

TLD-12W38LN-NB0	12 W	4000 K	PF>0,5	1100 lm	biały, white, белый, білий	aluminium aluminium алюминий алюміній	38°	370 g	5902801278563		
TLD-12W38LN-NB1					czarny, black, черный, чорний				5902801278570		
TLD-20W38LN-NB0	20 W	4000 K	PF>0,9	1800 lm	biały, white, белый, білий	aluminium aluminium алюминий алюміній	38°	560 g	5902801278495		
TLD-20W38LN-NB1					czarny, black, черный, чорний				5902801278631		
TLD-30W38LN-NB0	30 W	4000 K	PF>0,9	2700 lm	biały, white, белый, білий	aluminium aluminium алюминий алюміній	38°	710 g	5902801278594		
TLD-30W38LN-NB1					czarny, black, черный, чорний				5902801278617		



PL Reflektor LED X-Line
 EN X-Line LED track light fixture
 RU Светодиодный трековый светильник X-Line
 UK Світлодіодний трековий світильник X-Line



XLD-1524XLN-CB0	15 W	● 3000 K	1094 lm	biały, white, белый, білий	24°	0,6 kg	5901867199799
XLD-1540XLN-CB0					40°		5901867199805
XLD-1560XLN-CB0					60°		5901867199812
XLD-1524XLN-NB0		● 4000 K			24°		5901867199829
XLD-1540XLN-NB0					40°		5901867199836
XLD-1560XLN-NB0					60°		5901867199843
XLD-3024XLN-CB0	30 W	● 3000 K	2052 lm		24°	1,2 kg	5901867199850
XLD-3040XLN-CB0					40°		5901867199867
XLD-3060XLN-CB0					60°		5901867199874
XLD-3024XLN-NB0		● 4000 K			24°		5901867199881
XLD-3040XLN-NB0					40°		5901867199898
XLD-3060XLN-NB0					60°		5901867199904
XLD-4024XLN-CB0	40 W	● 3000 K	3245 lm	24°	1,5 kg	5901867199911	
XLD-4040XLN-CB0				40°		5901867199928	
XLD-4060XLN-CB0				60°		5901867199935	
XLD-4024XLN-NB0		● 4000 K		24°		5901867199942	
XLD-4040XLN-NB0				40°		5901867199959	
XLD-4060XLN-NB0				60°		5901867199966	

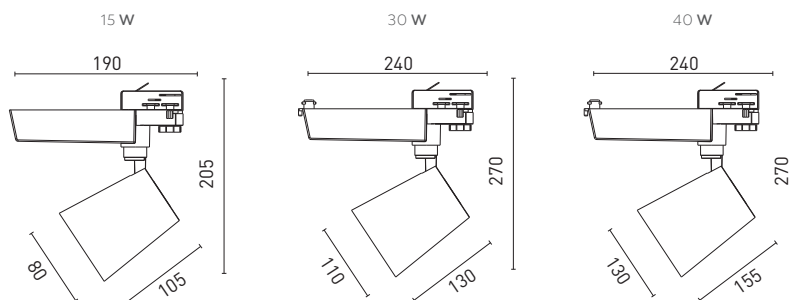

PL Reflektor LED X-Line
 EN X-Line LED track light fixture
 RU Светодиодный трековый светильник X-Line
 UK Світлодіодний трековий світильник X-Line



XLD-1524XLN-CB1	15 W	● 3000 K	1094 lm	24°	0,6 kg	5901867199973
XLD-1540XLN-CB1						5901867199980
XLD-1560XLN-CB1						5902801000010
XLD-1524XLN-NB1		● 4000 K				5902801000027
XLD-1540XLN-NB1						5902801000034
XLD-1560XLN-NB1						5902801000041
XLD-3024XLN-CB1	30 W	● 3000 K	2052 lm	24°	1,2 kg	5902801000058
XLD-3040XLN-CB1						5902801000065
XLD-3060XLN-CB1						5902801000072
XLD-3024XLN-NB1		● 4000 K				5902801000089
XLD-3040XLN-NB1						5902801000096
XLD-3060XLN-NB1						5902801000102
XLD-4024XLN-CB1	40 W	● 3000 K	3245 lm	24°	1,5 kg	5902801000119
XLD-4040XLN-CB1						5902801000126
XLD-4060XLN-CB1						5902801000133
XLD-4024XLN-NB1		● 4000 K				5902801000140
XLD-4040XLN-NB1						5902801000157
XLD-4060XLN-NB1						5902801000164

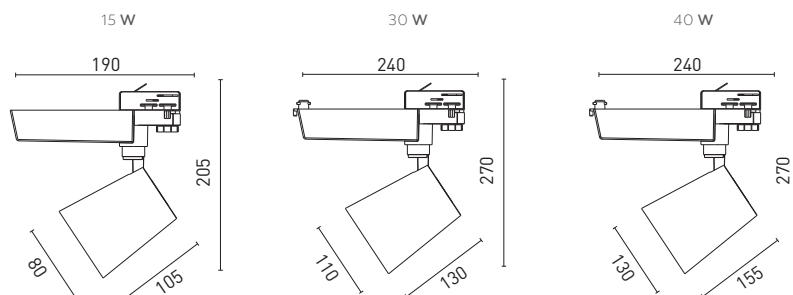



SZYNOPRZEWODY
TRACK SYSTEMS
ШИНОПРОВОД
ШИНОПРОВІД



PL Szynoprzewód 3-fazowy
EN 3-circuit track
RU Шинопровод 3-фазовый
UK Шинопровід 3-фазовий

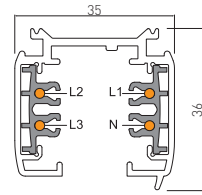

XTR-RA3FZ1B-00	biały, white, белый, білий	1 m	5901867193131
XTR-RA3FZ1C-10	czarny, black, черный, чорний	1 m	5901867193155
XTR-RA3FZ2B-00	biały, white, белый, білий	2 m	5901867193162
XTR-RA3FZ2C-10	czarny, black, черный, чорний	2 m	5901867193179



PL Zakończenie szynoprzewodu
EN End cap
RU Заглушка шинопровода
UK Заглушка шинопроводу

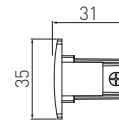

XAE-ZKUNCB-00	biały, white, белый, білий	5901867193346
XAE-ZKUNCC-10	czarny, black, черный, чорний	5901867193353

PL Końcówka zasilająca
EN End cap power connector
RU Наконечник подвода питания
UK Кінцівка з можливістю живлення

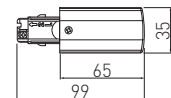

XAE-KZASLB-00	biały, white, белый, білий	5901867193308
XAE-KZASLC-10	czarny, black, черный, чорний	5901867193315



PL Końcówka zasilająca
EN End cap power connector
RU Наконечник подвода питания
UK Кінцівка з можливістю живлення

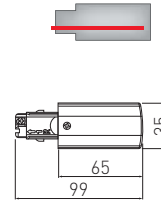

XAE-KZASPB-00	biały, white, белый, білий	5901867193339
XAE-KZASPC-10	czarny, black, черный, чорний	5901867193322



PL Łącznik „L” regulowany
EN "L"-shape power connector
RU Соединитель угловой 90°
UK З'єднувач кутювий 90° регульований

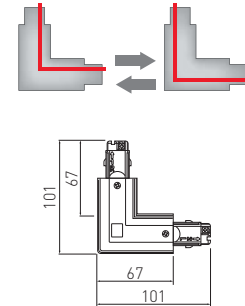

XAE-LKLRZWB-00	biały, white, белый, білий	5901867193544
XAE-LKLRZWC-10	czarny, black, черный, чорний	5901867193551



PL Łącznik „L”
EN "L"-shape power connector
RU Соединитель угловой 90°
UK З'єднувач кутювий 90° з можливістю живлення

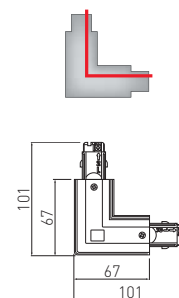

XAE-LKLPWB-00	biały, white, белый, білий	5901867193407
XAE-LKLPWC-10	czarny, black, черный, чорний	5901867193414





PL Łącznik „L”
EN "L"-shape power connector
RU Соединитель угловой 90°
UK З'єднувач кутовий 90°
з можливістю живлення

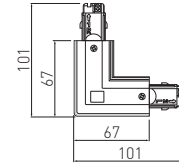

XAE-LKLLZB-00	biały, white, белый, білий	5901867193421
XAE-LKLLZC-10	czarny, black, черный, чорний	5901867193438



PL Łącznik „T”
EN "T"-shape power connector
RU Соединитель угловой „T”
UK З'єднувач кутовий "T"
з можливістю живлення

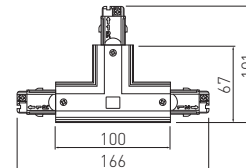
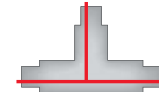

XAE-LKTZPB-00	biały, white, белый, білий	5901867193469
XAE-LKTZPC-10	czarny, black, черный, чорний	5901867193476



PL Łącznik „T”
EN "T"-shape power connector
RU Соединитель угловой „T”
UK З'єднувач кутовий "T"
з можливістю живлення

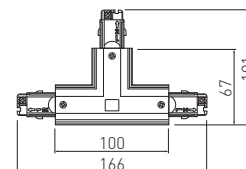
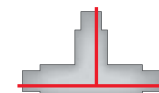

XAE-LKTZLB-00	biały, white, белый, білий	5901867193483
XAE-LKTZLC-10	czarny, black, черный, чорний	5901867193490





PL Łącznik „T”
EN "T"-shape power connector
RU Соединитель угловой „T”
UK З'єднувач кутовий "Т"
з можливістю живлення

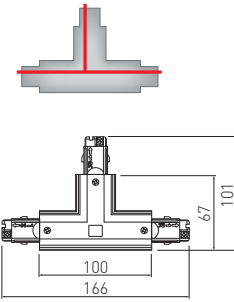

XAE-LKTWPB-00	biały, white, белый, білий	5902801001284
XAE-LKTWPC-10	czarny, black, черный, чорний	5902801001291



PL Łącznik „T”
EN "T"-shape power connector
RU Соединитель угловой „T”
UK З'єднувач кутовий "Т"
з можливістю живлення

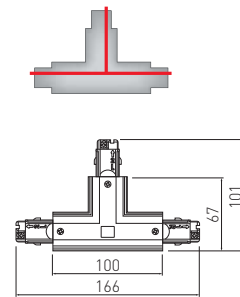

XAE-LKTWLB-00	biały, white, белый, білий	5902801001307
XAE-LKTWLC-10	czarny, black, черный, чорний	5902801001314



PL Łącznik „X”
EN "X"-shape power connector
RU Соединитель угловой „X”
UK З'єднувач кутовий "Х"
з можливістю живлення

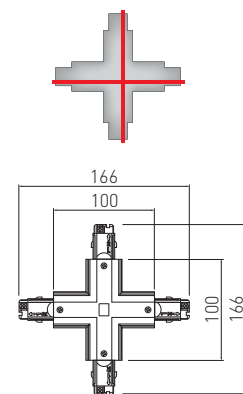

XAE-LKXUB-00	biały, white, белый, білий	5901867193445
XAE-LKXUC-10	czarny, black, черный, чорний	5901867193452





PL Łącznik „T” regulowany
EN "T"-shape power connector
RU Соединитель угловой „Т”
UK З'єднувач кутовий "Т" регульований

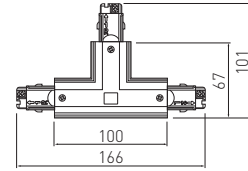
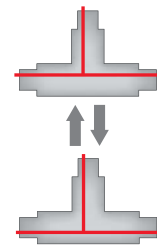

XAE-LKTRZWPB-00	biały, white, белый, білий	5901867193568
XAE-LKTRZWPC-10	czarny, black, черный, чорний	5901867193575



PL Łącznik „T” regulowany
EN "T"-shape power connector
RU Соединитель угловой „Т”
UK З'єднувач кутовий "Т" регульований

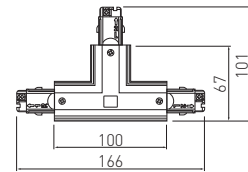
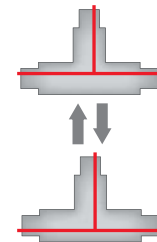

XAE-LKTRZWLB-00	biały, white, белый, білий	5901867193582
XAE-LKTRZWLC-10	czarny, black, черный, чорний	5901867193599



PL Łącznik prosty
EN Power connector
RU Соединитель электрический
UK З'єднувач електричний

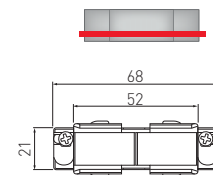

XAE-LKELB-00	biały, white, белый, білий	5901867193360
XAE-LKELC-10	czarny, black, черный, чорний	5901867193377





PL Łącznik prosty
EN Power connector
RU Соединитель электрический
UK З'єднувач електричний
з можливістю живлення

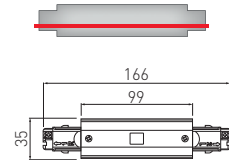

XAE-LELZB-00	biały, white, белый, білий	5901867193384
XAE-LELZC-10	czarny, black, черный, чорний	5901867193391



PL Łącznik regulowany
EN Adjustable power connector
RU Соединитель регулируемый
UK З'єднувач електричний
регульований

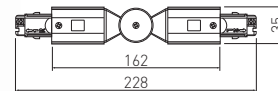
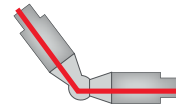

XAE-LKRUB-00	biały, white, белый, білий	5901867193520
XAE-LKRUC-10	czarny, black, черный, чорний	5901867193537



PL Łącznik elastyczny
EN Flexible power connector
RU Соединитель гибкий
UK З'єднувач електричний гнучкий

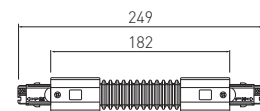
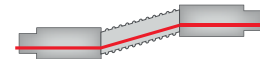

XAE-LELUB-00	biały, white, белый, білий	5901867193506
XAE-LELUC-10	czarny, black, черный, чорний	5901867193513





- PL Mocowanie sufitowe
- EN Suspension kit
- RU Набор для подвешивания
- UK Стельове кріплення



XAE-MSUNB-00	biały, white, белый, білий	5901867193766
XAE-MSUNC-10	czarny, black, черный, чорний	5901867193773

- PL Zestaw mocowanie sufitowe E-Z Click z linką
- EN Ceiling mount suspension kit with wire
- RU Крепление потолочное E-Z Click
- UK Набір стельових кріплень E-Z Click

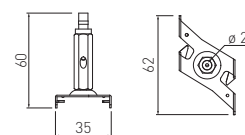
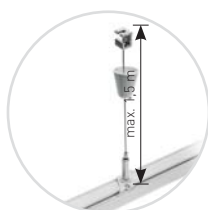

XAE-ZZWECLB-00	biały, white, белый, білий	5901867193605
XAE-ZZWECLC-10	czarny, black, черный, чорний	5901867193612

- PL Zestaw mocowanie sufitowe 120 mm z linką
- EN Ceiling mount suspension kit with wire
- RU Крепление потолочное усиленное
- UK Посиліне стельове кріплення

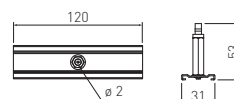

XAE-ZZWL120B-00	biały, white, белый, білий	5901867193667
XAE-ZZWL120C-10	czarny, black, черный, чорний	5901867193674

Track systems

PL Łącznik mechaniczny 182 mm
 EN Suspension clamp for track connection
 RU Подвесной зажим для подключения дорожки
 UK З'єднувач механічний 182 мм



XAE-LMIZB-00	biały, white, белый, білий	5901867193742
XAE-LMIZC-10	czarny, black, черный, чорний	5901867193759

PL Mocowanie sufitowe E-Z Click T25
 EN E-Z Click T25 ceiling mounting kit
 RU Крепление потолочное E-Z Click
 UK Стельове кріплення E-Z Click T25



XAE-MSEZB-00	biały, white, белый, білий	5901867193629
XAE-MSEZC-10	czarny, black, черный, чорний	5901867193636

PL Mocowanie sufitowe 120 mm T25
 EN Reinforced ceiling mounting kit
 RU Крепление потолочное усиленное
 UK Стельове кріплення посилене



XAE-MS120B-00	biały, white, белый, білий	5901867193704
XAE-MS120C-10	czarny, black, черный, чорний	5901867193711





- PL Baza do montażu natynkowego
- EN Fixed monopint track adapter
- RU База для поверхностного монтажа
- UK База для поверхневого монтажу

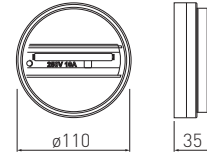

XAE-BNADB-00	biały, white, белый, білий	5901867193780
XAE-BNADC-10	czarny, black, черный, чорний	5901867193797

- PL Haczyk do zawieszenia
- EN Suspension hook
- RU Крючок для подвески
- UK Гачок для підвіски

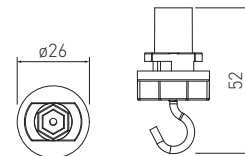

XAE-HMKB-00	biały, white, белый, білий	5901867193728
XAE-HMKC-10	czarny, black, черный, чорний	5901867193735

- PL Gniazdo SCHUKO
- EN SCHUKO outlet
- RU Гнездо SCHUKO
- UK Розетка SCHUKO

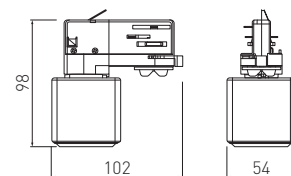

XAE-GNSCH-00	biały, white, белый, білий	5901867193803
--------------	----------------------------	---------------



Zakończenie szynoprzewodu
End cap
Заглушка шинпровода
Заглушка шинпровода

Łącznik „X”
"X"-shape power connector
Соединитель угловой „X”
З'єднувач кутовий "X"
з можливістю живлення

Łącznik „T”
"T"-shape power connector
Соединитель угловой „T”
З'єднувач кутовий "T"
з можливістю живлення

Łącznik „L”
"L"-shape power connector
Соединитель угловой 90°
З'єднувач кутовий 90°
з можливістю живлення

Łącznik prosty
Power connector
Соединитель электрический
З'єднувач електричний

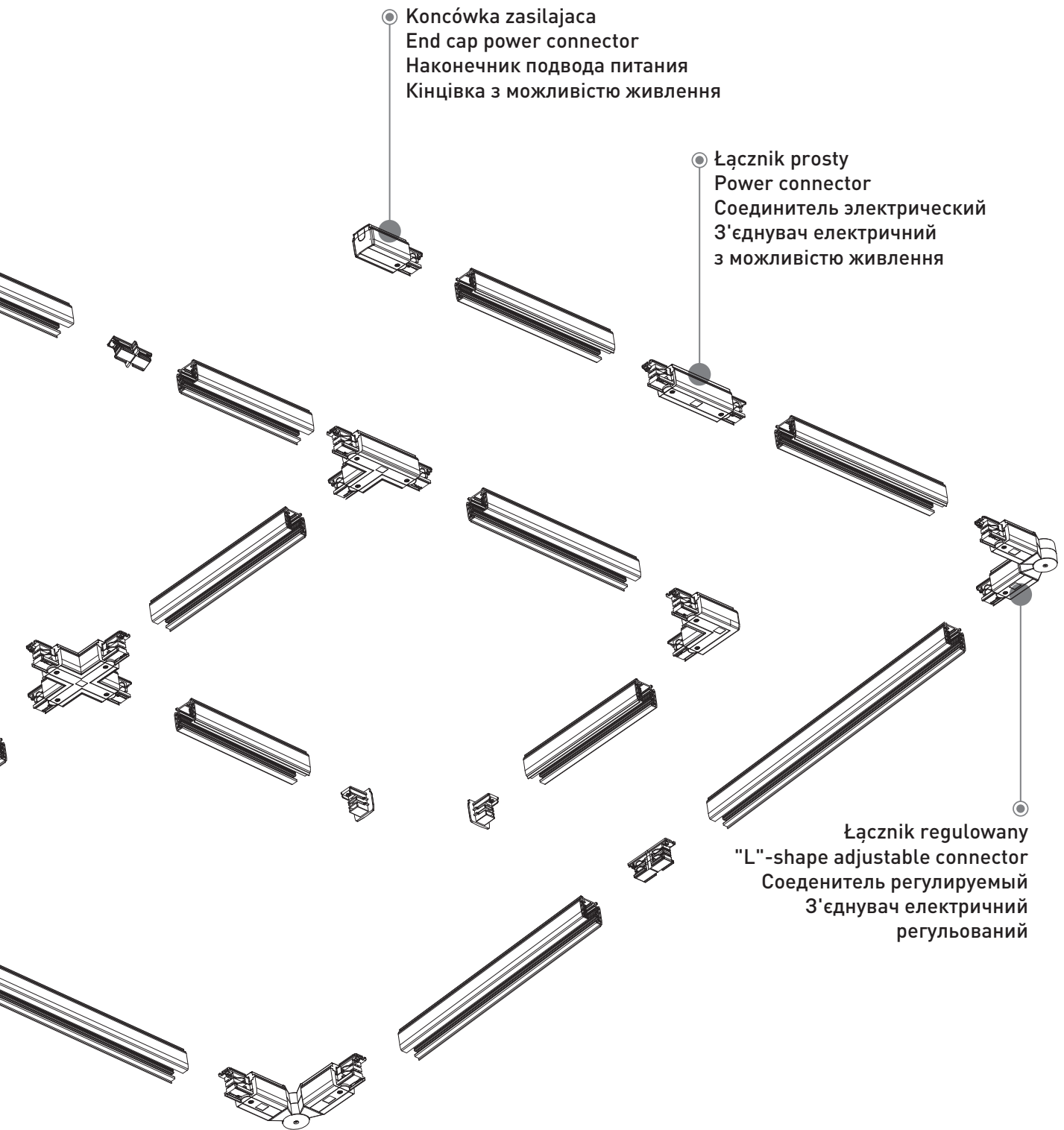

● **Koncówka zasilajaca**
End cap power connector
Наконечник подвода питания
Кінцівка з можливістю живлення

● **Łącznik prosty**
Power connector
Соединитель электрический
З'єднувач електричний
з можливістю живлення

● **Łącznik regulowany**
"L"-shape adjustable connector
Соединитель регулируемый
З'єднувач електричний
регульований

PL Schemat łączenia
EN Connection diagram
RU Схема подключения
UK Схема підключення

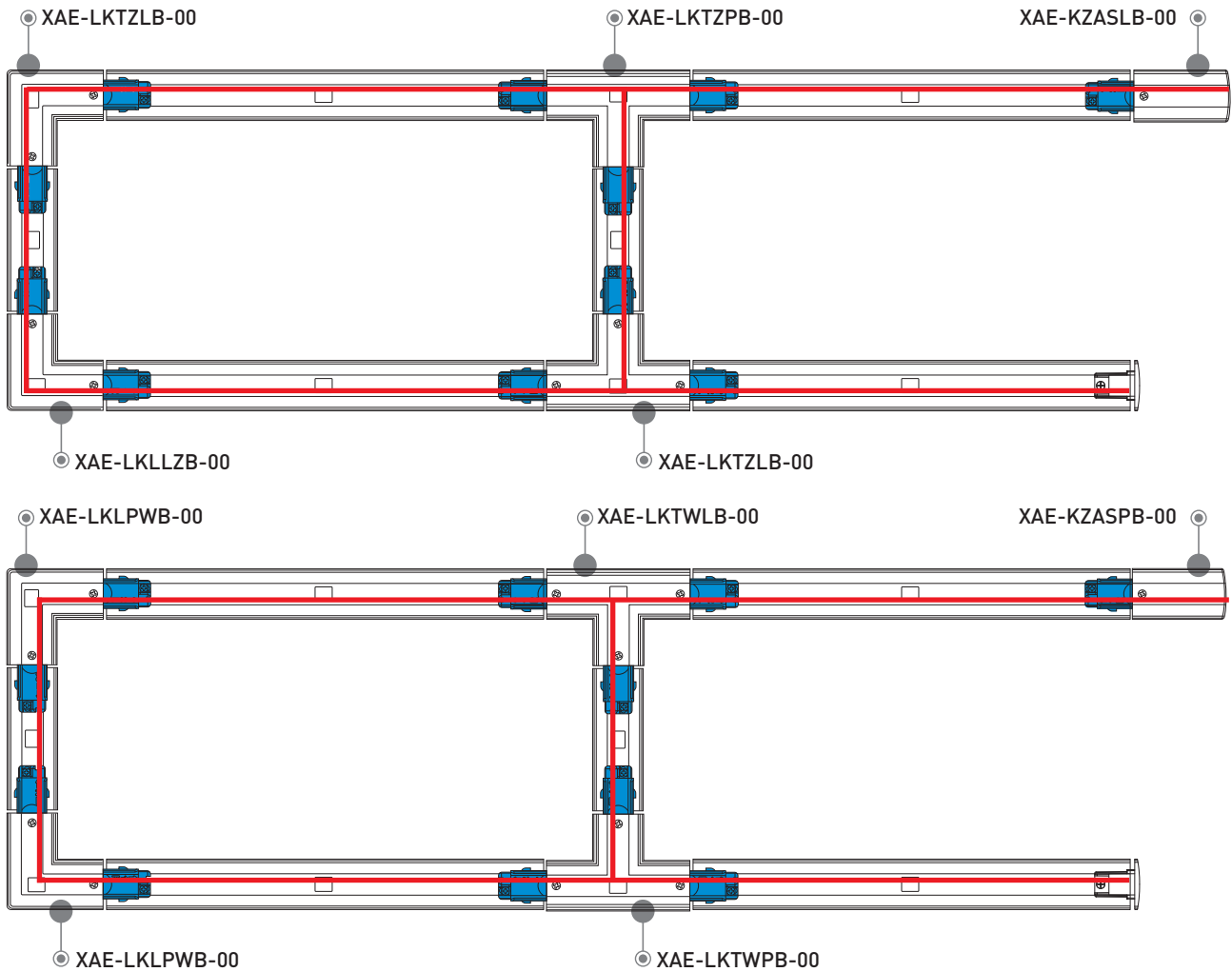

Szynoprzewód jest asymetryczny - przy doborze elementów należy zwrócić uwagę na ciągłość toru N.

Track is asymmetrical - while choosing the parts please make sure that the track N is continuous.

Шинопровод асимметричен - При выборе элементов, обратите внимание на непрерывность трека N.

Шинопрвід є асиметричним - при підборі елементів належить звернути увагу на неперервність треку N

Na rysunkach, tor N jest zaznaczony czerwoną linią.

The track N is marked with a red line on drawing.

На чертежах, трек N отмечен красной линией.

На схемі трек N позначений червоною лінією





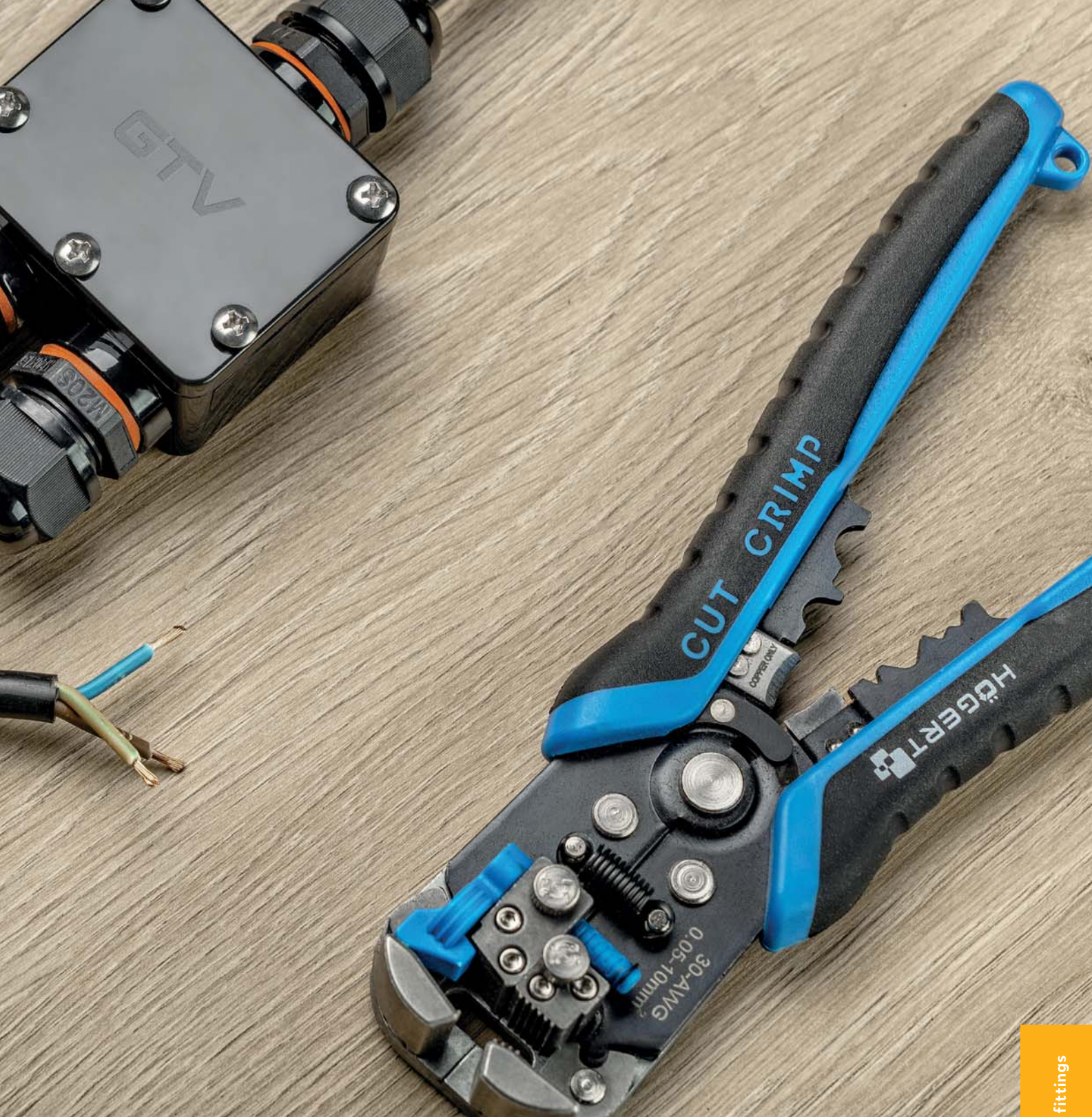

OSPRZĘT ELEKTROINSTALACYJNY
INSTALLATION FITTINGS
ЭЛЕКТРОУСТАНОВОЧНЫЕ ИЗДЕЛИЯ
ЕЛЕКТРОМОНТАЖНІ ВИРОБИ

Osprzęt elektroinstalacyjny
Installation fittings
Электроустановочные изделия
Електромонтажні вироби 255





PL Czujnik ruchu
EN Motion detector
RU Датчик движения
UK Датчик руху



CR-1



CR-CR1000-10



CR-CR1000-00

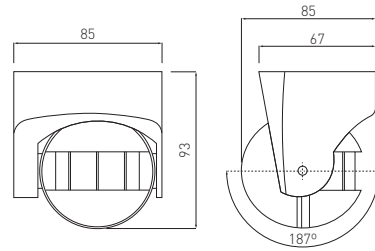

CR-CR1000-10	tworzywo, plastic, пластмасса, пластик	czarny, black, черный, чорний	160 g	5908231308184
CR-CR1000-00		biały, white, белый, білий		5908231308160



PL Czujnik ruchu
EN Motion detector
RU Датчик движения
UK Датчик руху



CR-2



CR-CR2000-10



CR-CR2000-00

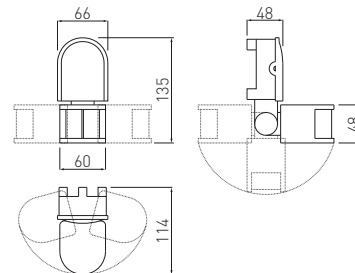

CR-CR2000-10	tworzywo, plastic, пластмасса, пластик	czarny, black, черный, чорний	180 g	5908231308238
CR-CR2000-00		biały, white, белый, білий		5908231308207



Installation fittings

PL Czujnik ruchu
EN Motion detector
RU Датчик движения
UK Датчик руху

CR-3

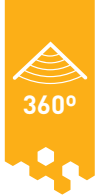
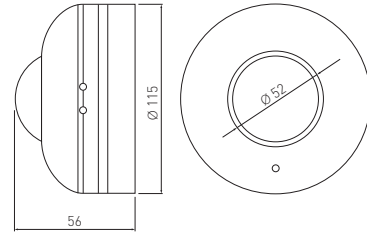

CR-CR3000-00	tworzywo, plastic, пластмасса, пластик	biały, white, белый, білий	170 g	5908231308146
--------------	--	----------------------------	-------	---------------



PL Czujnik ruchu
EN Motion detector
RU Датчик движения
UK Датчик руху

CR-3 MINI

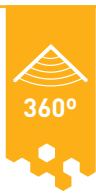
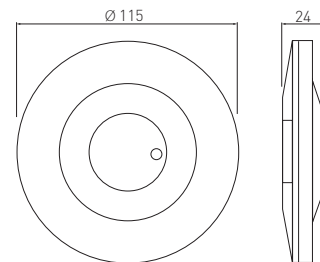

CR-CR3M00-00	tworzywo, plastic, пластмасса, пластик	biały, white, белый, білий	100 g	5901867146076
--------------	--	----------------------------	-------	---------------



PL Czujnik ruchu
EN Motion detector
RU Датчик движения
UK Датчик руху

CR-4

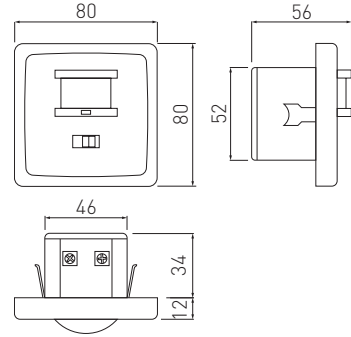

CR-CR4L00-00	tworzywo, plastic, пластмасса, пластик	biały, white, белый, білий	100 g	5908231308122
--------------	--	----------------------------	-------	---------------



PL Czujnik ruchu
EN Motion detector
RU Датчик движения
UK Датчик руху

CR-5

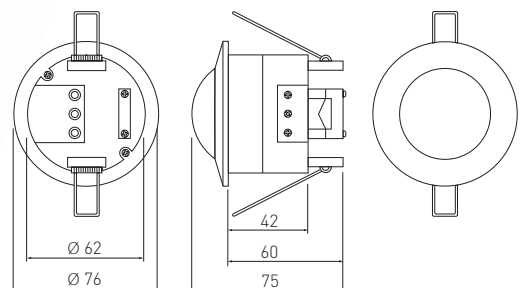

CR-CR5000-00	tworzywo, plastic, пластмасса, пластик	biały, white, белый, білий	100 g	5908231308115
--------------	--	----------------------------	-------	---------------



PL Czujnik ruchu wpuszczany
EN Recessed motion detector
RU Датчик движения скрытый
UK Вбудований датчик руху

CR-5 MINI

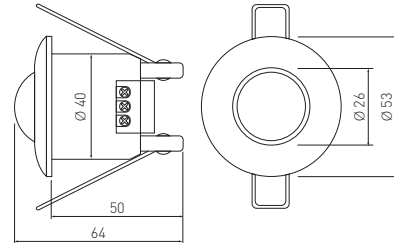

CR-CR5M00-00	tworzywo, plastic, пластмасса, пластик	biały, white, белый, білий	50 g	5901867108890
--------------	--	----------------------------	------	---------------



PL Czujnik ruchu na podczerwień
EN Infrared motion sensor
RU Датчик движения инфракрасный
UK Сенсор руху із зовнішнім інфрачервоним сенсором

CR-6

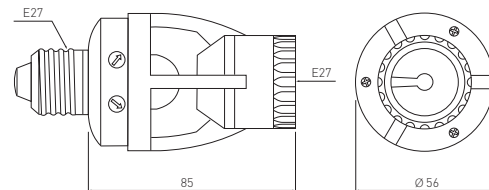

CR-CR6000-00	tworzywo, plastic, пластмасса, пластик	biały, white, белый, білий	80 g	5901867103437
--------------	--	----------------------------	------	---------------



PL Czujnik ruchu z zewnętrznym sensorem na podczerwień
 EN Motion detector with external IR sensor
 RU Датчик движения с наружным сенсором инфракрасный
 UK Сенсор руху із зовнішнім інфрачервоним сенсором



CR-7

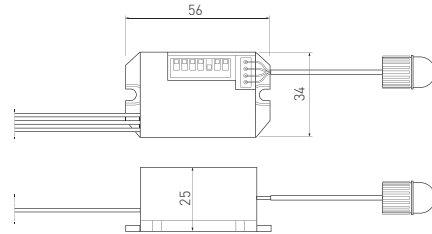

CR-CR7000-00	tworzywo, plastic, пластмасса, пластик	biały, white, белый, білий	170 g	5901867103444



PL Czujnik ruchu
 EN Motion detector
 RU Датчик движения
 UK Датчик руху



CR-8

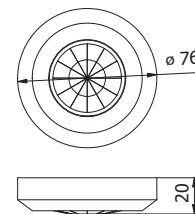

Installation fittings

CR-CR8000-00	tworzywo, plastic, пластмасса, пластик	biały, white, белый, білий	50 g	5902801294969



PL Czujnik ruchu
EN Motion detector
RU Датчик движения
UK Датчик руху

CR-9



CR-CR9000-00

CR-CR9000-10

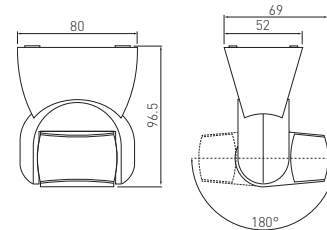

CR-CR9000-00	tworzywo, plastic, пластмасса, пластик	biały, white, белый, білий	5901867108906
CR-CR9000-10		czarny, black, черный, чорний	5901867138507



PL Czujnik ruchu
EN Motion detector
RU Датчик движения
UK Датчик руху

CR-9 mini



CR-CR9M00-00

CR-CR9M00-10

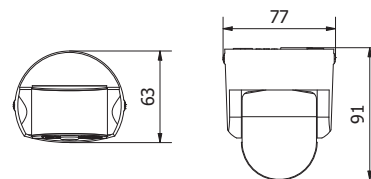

CR-CR9M00-00	PC	biały, white, белый, білий	120 g	5902801294433
CR-CR9M00-10		czarny, black, черный, чорний		5902801294518



Installation fittings

PL Czujnik ruchu
EN Motion and presence detector
RU Датчик движения и присутствия
UK Датчик руху та наявності

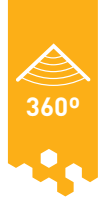

CO-1

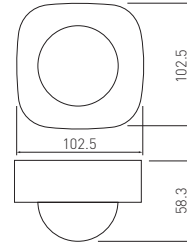

CR-CO1000-00	tworzywo, plastic, пластмасса, пластик	biały, white, белый, білий	140 g	5901867146090
--------------	--	----------------------------	-------	---------------



PL Czujnik ruchu i obecności
EN Motion detector
RU Датчик движения
UK Датчик руху



CR-11

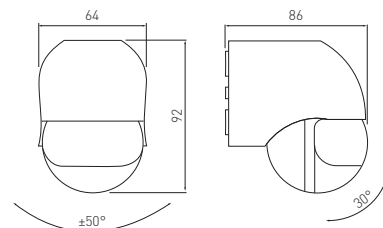

CR-CR1100-00	tworzywo, plastic, пластмасса, пластик	biały, white, белый, білий	160 g	5901867108913
--------------	--	----------------------------	-------	---------------



PL Czujnik ruchu
EN Motion detector
RU Датчик движения
UK Датчик руху

CR-13



Montaż narożny,
Corner mounting,
Угловой монтаж,
Кутювий монтаж.

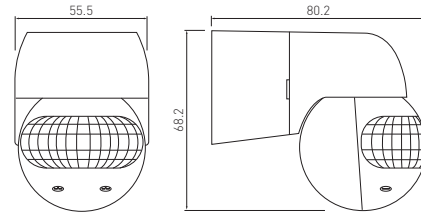

CR-CR13000-00	tworzywo, plastic, пластмасса, пластик	biały, white, белый, білий	120 g	5901867188274



PL Czujnik ruchu
EN Motion detector
RU Датчик движения
UK Датчик руху

CR-14

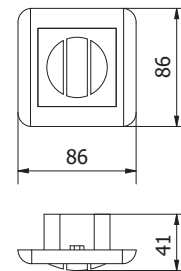

CR-CR1400-00	tworzywo, plastic, пластмасса, пластик	biały, white, белый, білий	82 g	5902801294174



Installation fittings

PL Czujnik ruchu
EN Motion detector
RU Датчик движения
UK Датчик руху

CR-15

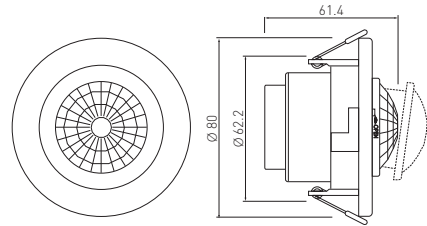

CR-CR15000-00	tworzywo, plastic, пластмасса, пластик	biały, white, белый, білий	90 g	5901867188212
---------------	--	----------------------------	------	---------------



PL Czujnik ruchu
EN Motion detector
RU Датчик движения
UK Датчик руху

CR-16

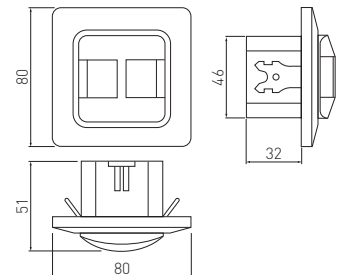

CR-CR16000-00	tworzywo, plastic, пластмасса, пластик	biały, white, белый, білий	88 g	5902801002533
---------------	--	----------------------------	------	---------------



PL Czujnik ruchu
EN Motion detector
RU Датчик движения
UK Датчик руху

CR-17

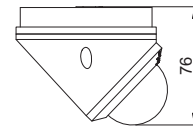
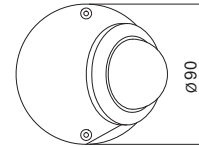

CR-CR17000-00	tworzywo, plastic, пластмасса, пластик	biały, white, белый, білий	55 g	5902801282102
---------------	--	----------------------------	------	---------------



PL Czujnik ruchu
EN Motion detector
RU Датчик движения
UK Датчик руху

CR-18

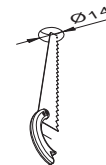
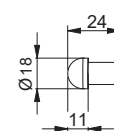
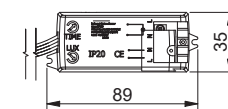
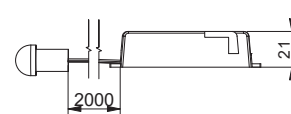

CR-CR18000-00	PC	biały, white, белый, білий	55 g	5902801282058
---------------	----	----------------------------	------	---------------



Installation fittings

PL Czujnik ruchu
EN Motion detector
RU Датчик движения
UK Датчик руху

CR-19

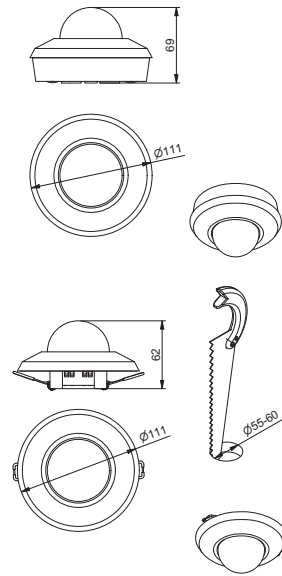

CR-CR19000-00	PC	biały, white, белый, білий	170 g	5902801282140



PL Czujnik ruchu mikrofalowy
EN Microwave motion sensor
RU Микроволновой датчик движения
UK Мікрохвильовий датчик руху

CM-1

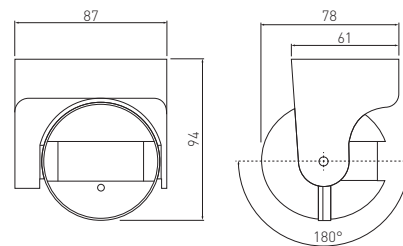

AE-CM1000-00	tworzywo, plastic, пластмасса, пластик	biały, white, белый, білий	160 g	5901867108876



PL Czujnik ruchu mikrofalowy
 EN Microwave motion sensor
 RU Микроволновой датчик движения
 UK Мікрохвильовий датчик руху

CM-3

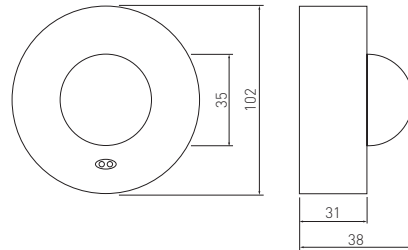

AE-CM3000-00	tworzywo, plastic, пластмасса, пластик	biały, white, белый, білий	170 g	5908231339997



PL Czujnik ruchu mikrofalowy
 EN Microwave motion sensor
 RU Микроволновой датчик движения
 UK Мікрохвильовий датчик руху

CM-3 MINI

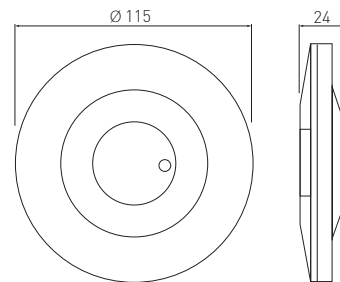

AE-CM3M00-00	tworzywo, plastic, пластмасса, пластик	biały, white, белый, білий	110 g	5901867188250



PL Czujnik ruchu mikrofalowy
EN Microwave motion sensor
RU Микроволновой датчик движения
UK Мікрохвильовий датчик руху



CM-4

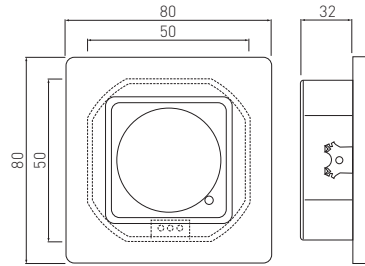

AE-CM4000-00	tworzywo, plastic, пластмасса, пластик	biały, white, белый, білий	90 g	5901867188236
--------------	--	----------------------------	------	---------------



PL Czujnik ruchu mikrofalowy
EN Microwave motion sensor
RU Микроволновой датчик движения
UK Мікрохвильовий датчик руху



CM-5

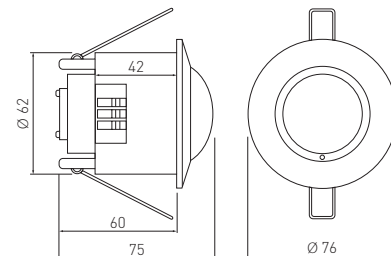

AE-CM5000-00	tworzywo, plastic, пластмасса, пластик	biały, white, белый, білий	100 g	5901867108883
--------------	--	----------------------------	-------	---------------



PL Czujnik ruchu mikrofalowy
EN Microwave motion sensor
RU Микроволновой датчик движения
UK Мікрохвильовий датчик руху

CM-9



AE-CM9000-00



AE-CM9000-10

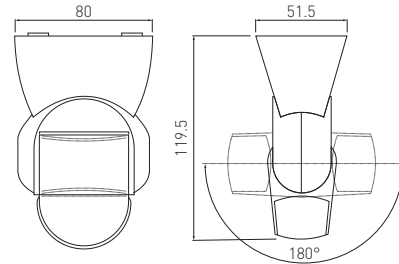

AE-CM9000-00	tworzywo, plastic, пластмасса, пластик	biały, white, белый, білий	161 g	5901867196972
AE-CM9000-10		czarny, black, черный, чорний		5901867196996



PL Czujnik ruchu mikrofalowy
EN Microwave motion sensor
RU Микроволновой датчик движения
UK Мікрохвильовий датчик руху

CM-15

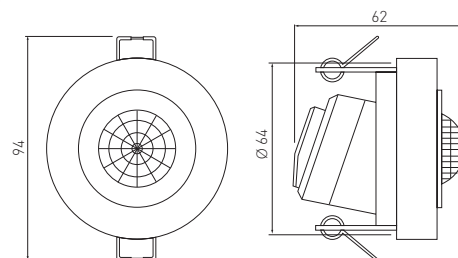

AE-CM1500-00	tworzywo, plastic, пластмасса, пластик	biały, white, белый, білий	103 g	5902801002519



Installation fittings

PL Czujnik ruchu mikrofalowy
 EN Microwave motion sensor
 RU Микроволновой датчик движения
 UK Мікрохвильовий датчик руху



SRC812-MINI

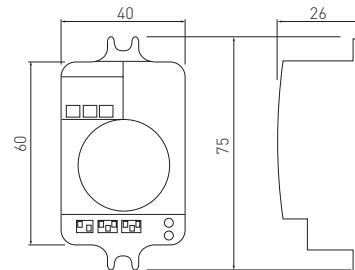

AE-SRC812-MIN	tworzywo, plastic, пластмасса, пластик	biały, white, белый, білий	40 g	5901867124326



PL Czujnik ruchu mikrofalowy
 EN Microwave motion sensor
 RU Микроволновой датчик движения
 UK Мікрохвильовий датчик руху



CR-16

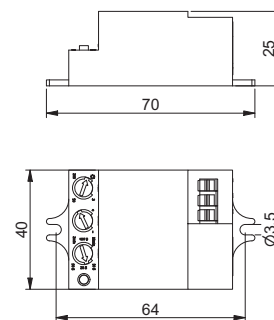

AE-SRC812-MIN2	PC	biały, white, белый, білий	40 g	5902801282133



Installation fittings

PL Czujnik ruchu mikrofalowy
EN Microwave motion sensor
RU Микроволновой датчик движения
UK Мікрохвильовий датчик руху

SRC812

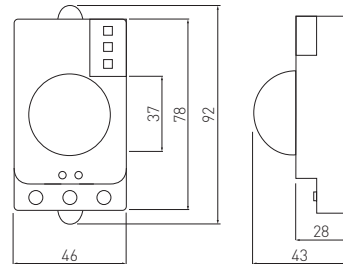

AE-SRC812-00	tworzywo, plastic, пластмасса, пластик	biały, white, белый, білий	70 g	5908231303738
--------------	--	----------------------------	------	---------------



PL Czujnik zmierzchowy
EN Twilight sensor
RU Датчик сумерек
UK Датчик сутінків

CZ-1

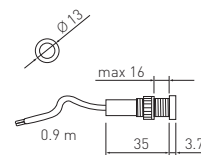
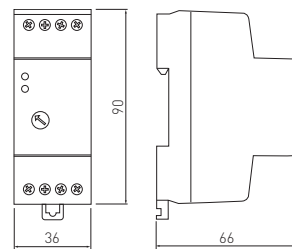

CZ-CZ1000-00	tworzywo, plastic, пластмасса, пластик	biały, white, белый, білий	130 g	5901867108920
--------------	--	----------------------------	-------	---------------



Installation fittings

PL Czujnik zmierzchowy
EN Twilight sensor
RU Датчик сумерек
UK Датчик сутінків

CZ-2

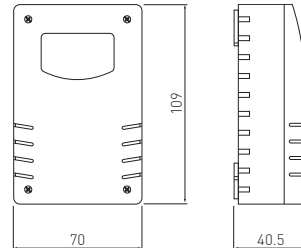

CZ-CZ2000-00	tworzywo, plastic, пластмасса, пластик	biały, white, белый, білий	50 g	5901867108937
--------------	--	----------------------------	------	---------------



PL Gniazdko elektryczne z USB
EN Power socket with USB
RU Электрическая розетка с USB
UK Електрична розетка з USB

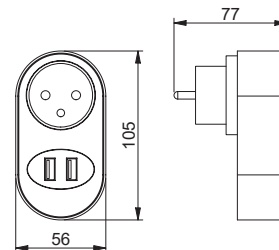

AE-GSF2USB-10	french, 2xUSB	PC	biały, white, белый, білий	100 g	5902801202490
AE-GSS2USB-10	schuko, 2xUSB				5902801202254



- PL Programator czasowy mechaniczny 24 h
- EN 24h programmable timer
- RU Временной механический программатор 24 ч.
- UK Механічний програматор часу 24 години



PC-MECH24-00



PC-MECH24-SC

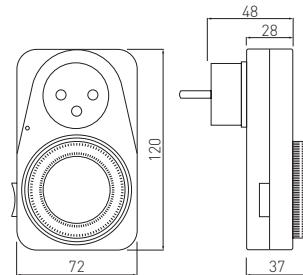

PC-MECH24-00	tworzywo, plastic, пластмасса, пластик	biały, white, белый, білий	140 g	5908231327215
PC-MECH24-SC				5908231351104



- PL Programator czasowy elektroniczny 7 dniowy 24 h
- EN 24 h, 7 day electronic programmable timer
- RU Временной электронный программатор
- UK Електронний програматор на 7 днів 24 години



PC-ELE724-00



PC-ELE724-SC

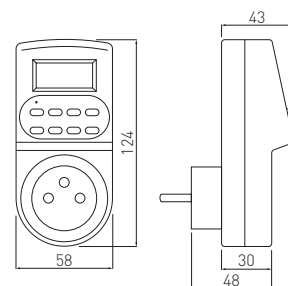

PC-ELE724-00	tworzywo, plastic, пластмасса, пластик	biały, white, белый, білий	150 g	5908231327208
PC-ELE724-SC				5908231351128



PL Przedłużacz domowy
EN Extension cord
RU Удлинитель для офиса
UK Домашній подовжувач



Folder	Length (m)	Number of outlets	Cable type	Barcode
AE-PS3G3M-00	3 m	3	H05VV-F 3x1.5 mm ²	5908231301192
AE-PS3G5M-00	5 m			5908231301208
AE-PS4G3M-00	3 m	4		5908231301215
AE-PS4G5M-00	5 m			5908231301222
AE-PS5G3M-00	3 m	5		5908231301239
AE-PS5G5M-00	5 m			5908231301246



PL Przedłużacz domowy
EN Extension cord
RU Удлинитель для офиса
UK Домашній подовжувач



Folder	Length (m)	Number of outlets	Cable type	Barcode
AE-PF3G1M-00	1,5 m	3	H05VV-F 3G1.0 mm ²	5901867170057
AE-PF3G3M-00	3 m			5901867170033
AE-PF3G5M-00	5 m			5901867170040
AE-PF5G3M-00	3 m	5		5901867170064
AE-PF5G5M-00	5 m			5901867170071



- PL Przedłużacz bębnowy (schuko)
 EN Extension cord reel (schuko socket)
 RU Удлинитель барабанный (гнездо schuko)
 UK Барабанный подовжувач (schuko)



AE-SBEBEN-30	30 m	4	3 x 1,5 mm ²	tworzywo + stal plastic + steel	czarny, black, черный, чорний	5908231322722
AE-SBEBEN-50	50 m					5908231322739



- PL Przedłużacz bębnowy z wyłącznikiem termicznym
 EN Extension cord reel with a thermal switch
 RU Удлинитель барабанный с тепловым выключателем
 UK Барабанный подовжувач з термічним вимикачем



AE-PFBEBEN-20	20 m	4	3 x 1 mm ²	tworzywo + stal plastic + steel	czarny, black, черный, чорний	5901867170088
AE-PFBEBEN-40	40 m					5901867170095



PL Przedłużacz ogrodowy
EN Garden extension cord
RU Удлинитель садовый
UK Садовий подовжувач

10 A

3 years warranty



AE-POGRODUN-10	10 m	2 x 1,0 mm ²	pomarańczowy, orange, оранжевый, помаранчевий.	5901867163387
AE-POGRODUN-20	20 m			5901867163394
AE-POGRODUN-30	30 m			5901867163400



PL Gniazdo do lamp
EN Lamp base socket
RU Разъем для ламп
UK Гніздо для ламп

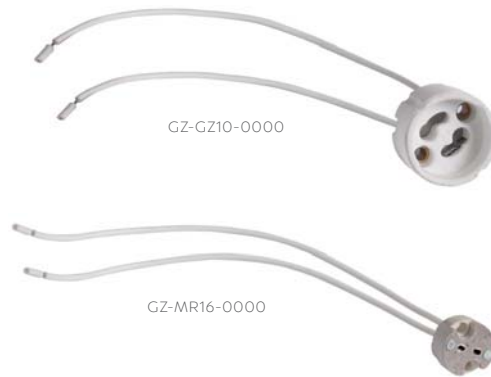

GZ-GZ10-0000	biały, white, белый, білий	5908231305756
GZ-MR16-0000*		5908231331656





PL Gniazdo do lamp
EN Lamp base socket
RU Разъем для ламп
UK Гніздо для ламп



GZ-G90000-00

biały, white, белый, білий

5902801222665



PL Rozgałęziacz z uziemieniem
EN Outlet junction with PE
RU Разветвитель с заземлением
UK Відгалужувач із заземленням



INFO



AE-RU0121-00

1 na 2 + 1, 2+1-way, 1 na 2 + 1.1 na 2 + 1

5908231301260



PL Rozgałęziacz z uziemieniem
EN Outlet junction with PE
RU Разветвитель с заземлением
UK Відгалужувач із заземленням



INFO



AE-RU0102-00

1 na 2, 2-way, 1 na 2, 1 na 2

5908231301253



PL Rozgałęziacz z uziemieniem
EN Outlet junction with PE
RU Разветвитель с заземлением
UK Відгалужувач із заземленням



AE-SC0102-00

biały, white, белый, білий

5908231360847



PL Rozgałęziacz z uziemieniem
EN Outlet junction with PE
RU Разветвитель с заземлением
UK Відгалужувач із заземленням



INFO



AE-SC0103-00

1 na 3 (schuko), 3-way (schuko)
1 на 3 (schuko), 1 на 3 (schuko)

5908231360854



PL Wtyczka płaska kątowa
EN Plane angular plug
RU Плоский угловой штекер
UK Вилка плоска кутова



INFO



AE-VA1UNI-00*

biały, white, белый, білий

5901867171887



PL Rozgałęziacz z uziemieniem
EN Outlet junction with PE
RU Разветвитель с заземлением
UK Відгалужувач із заземленням



INFO



AE-RU0103-00

1 na 3, 3-way, 1 на 3, 1 на 3

5908231301277



PL Oprawka ceramiczna
EN Ceramic lamp holder
RU Патрон керамический
UK Керамічний патрон

MAX
100 W



AE-OCEF27-00

biały, white, белый, білий

5908231302120



PL Oprawka ceramiczna
EN Ceramic lamp holder
RU Патрон керамический
UK Керамічний патрон

MAX
100 W



AE-OCEE14-00

biały, white, белый, білий

5908231302090



PL Oprawka ceramiczna
EN Ceramic lamp holder
RU Патрон керамический
UK Керамічний патрон

MAX
100 W

E27



AE-OCEE27-00

biały, white, белый, білий

5908231302106



PL Oprawka ceramiczna
EN Ceramic lamp holder
RU Патрон керамический
UK Керамічний патрон

MAX
100 W

E27



AE-OCHT27-00

złoty, gold, золото, золото

5908231302113



PL Oprawka
EN Lamp holder
RU Патрон
UK Патрон

MAX
100 W

E27



AE-OPE27K-00

biały, white, белый, білий

5901867143341



PL Oprawka
EN Lamp holder
RU Патрон
UK Керамічний патрон

MAX
100 W

E27



AE-OPE27P-00

biały, white, белый, білий

5901867143327



PL Gniazdo do lamp E27
EN Lamp socket E27
RU Гнездо для ламп E27
UK Гніздо для ламп E27



MAX
60 W

E27



GZ-E27000-10

czarny, black, черный, чорний

5902801292620

GZ-E27000-00

biały, white, белый, білий

5902801256226



PL Przejściówka
EN Adapter
RU Переходник
UK Перехідник



MAX
50 W

Installation fittings



INFO



AE-E14GU10-00

E14, GU10

biały, white, белый, білий

5908231391797



PL Przejściówka
EN Adapter
RU Переходник
UK Перехідник



INFO



AE-E14E27-00	E14, E27	biały, white, белый, білий	5901867112156
--------------	----------	----------------------------	---------------



PL Przejściówka
EN Adapter
RU Переходник
UK Перехідник



INFO



AE-E27E14-00	E27, E14	biały, white, белый, білий	5908231391780
--------------	----------	----------------------------	---------------



PL Przejściówka
EN Adapter
RU Переходник
UK Перехідник



INFO



AE-27GU10-00	E27, GU10	biały, white, белый, білий	5908231391803
--------------	-----------	----------------------------	---------------



PL Przejściówka
EN Adapter
RU Переходник
UK Перехідник



INFO



AE-GU10E27-00	GU10, E27	biały, white, белый, білий	5908231302540
---------------	-----------	----------------------------	---------------



PL Przejściówka
EN Adapter
RU Переходник
UK Перехідник



INFO



AE-E40E27-00	E40, E27	biały, white, белый, білий	5901867124227
--------------	----------	----------------------------	---------------



PL Obręcz mocująca E14, E27
EN Ring for E14, E27 sockets
RU Кольцо для патронов E14, E27
UK Кільце для патронів E14, E27



INFO



AE-E27RING-10	E27	biały, white, белый, білий	590186712421
AE-E14RING-10	E14		5901867124227





PL Wodoszczelny łącznik do przewodów elektrycznych
 EN Waterproof connector for electrical wiring
 RU Водонепроницаемый коннектор для электрических проводов
 UK Водонепроникний конектор для електричних проводів



WZL-2	tworzywo, plastic, пластмасса, пластик	czarny, black, черный, чорний	5901867122070
-------	--	-------------------------------	---------------



PL Wodoszczelny trójnik, łącznik do przewodów elektrycznych
 EN Waterproof "T"-shape connector for electrical wiring
 RU Водонепроницаемый тройник и соединитель для электрических проводов
 UK Водонепроникний трійник, конектор для електричних проводів



WZL-3	tworzywo, plastic, пластмасса, пластик	czarny, black, черный, чорний	5901867122094
-------	--	-------------------------------	---------------



PL Wodoszczelny trójnik, łącznik do przewodów elektrycznych
 EN Waterproof electrical wiring tee and connector
 RU Водонепроницаемый тройник и соединитель для электрических проводов
 UK Водонепроникний трійник, конектор для електричних проводів



WZL-4	tworzywo, plastic, пластмасса, пластик	czarny, black, черный, чорний	5902801016189
-------	--	-------------------------------	---------------





- PL Kostka z osłonką izolacyjną do opraw
- EN Connection block with insulation sleeve for fixtures
- RU Клемная колодка с крышкой для светильников
- UK Клемник з ізоляційним екраном для світильників



LZ-KOI2KO-10	czarny, black, черный, чорний	5901867199027
--------------	-------------------------------	---------------



- PL Złączki zaciskowe - elastyczne
- EN Flexible connection terminals
- RU Зажимные муфты - гибкие
- UK Обтискний конектор, еластичний

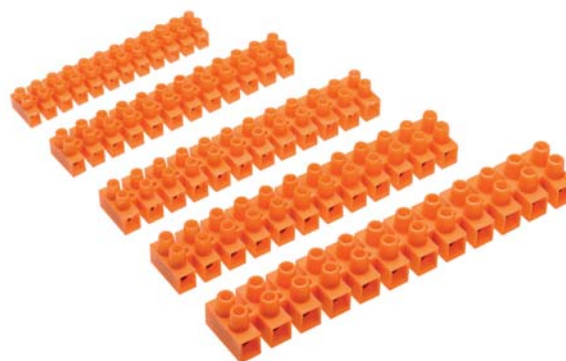

LZ-25MM00-00	24 A	polietylen, polietylen, полиэтилен, поліетилен	16 g	10	5908231331922
LZ-40MM00-00	32 A		26 g		5908231331939
LZ-60MM00-00	41 A		32 g		5908231331946
LZ-100MM0-00	57 A		46 g		5908231331892
LZ-160MM0-00	76 A		65 g		5908231331908
LZ-250MM0-00	101 A		96 g		5908231331915



Installation fittings



- PL Osłona sufitowa na kostkę elektryczną
 EN Ceiling cover for connection block
 RU Потолочная крышка для клеммной колодки
 UK Стельовий екран для електричного клемника



White

Black

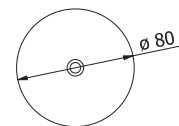

AE-MA8025-10	aluminium, aluminium, алюміній, алюміній	biały, white, белый, білий	90 g	5902801285066
AE-MA8025-00	aluminium, aluminium, алюміній, алюміній	czarny, black, черный, чорний	90 g	5902801285899



- PL Osłona sufitowa na kostkę elektryczną
 EN Ceiling cover for connection block
 RU Потолочная крышка для клеммной колодки
 UK Стельовий екран для електричного клемника



White

Black

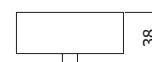
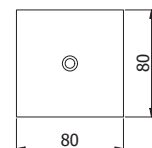

AE-MAS80X80-10	tworzywo, plastic, пластмасса, пластик.	biały, white, белый, білий	90 g	5902801245091
AE-MAS80X80-00	tworzywo, plastic, пластмасса, пластик.	czarny, black, черный, чорний	90 g	5902801244742





- PL Osłona sufitowa na kostkę elektryczną
- EN Ceiling cover for connection block
- RU Потолочная крышка для клеммной колодки
- UK Стельовий екран для електричного клемника



AE-CANOPY-10	biały, white, белый, білий	5901867124234
--------------	----------------------------	---------------

- PL Statyw do opraw halogenowych i ledowych
- EN Halogen / LED fixture stand
- RU Штатив для галогенных и светодиодных светильников
- UK Штатив для галогенних і світлодіодних світильників

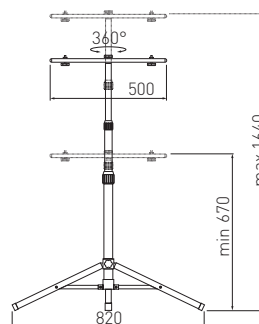

OH-ST2500-23	stal, steel, сталь, сталь	żółty, yellow, желтый, жовтий	2000 g	5908231360663
--------------	---------------------------	-------------------------------	--------	---------------





PL Kabel z wtyczką i włącznikiem, 2 m
 EN Cables with plug and switch, 2 m
 RU Кабели с вилкой и выключателем 2 м
 UK Кабель живлення 2 м з вилкою і вимикачем



LD-KABE2M-00	2 m	5908231335265
LD-KABE2M-10		5902801004018



PL Kabel z wtyczką
 EN Cables with plug
 RU Кабель с вилкой
 UK Кабель з вилкою



KB-W310HUG-20	1,5 m	5908231385871
KB-W313HUG-20	3 m	5902801003899



PL Zapłonnik
 EN Starter
 RU Стартер
 DE Стартер



INFO



OS-STA422-00	4-22 W, 230 V AC	5908231332578
OS-STA465-00	4-65 W, 230 V AC	5908231332585



PL Statecznik elektroniczny
EN Electric driver
RU Электронный балласт
UK Електронний пусковий пристрій

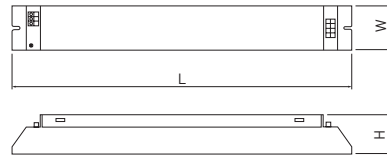

Folder	W	Weight	LxWxH	Barcode
OS-SEL236-ZHQ	2 x 36 W / T8	70 g	210 x 28 x 30 mm	5902801038174
OS-SEL418-ZHQ	4 x 18 W / T8	78 g		5902801038167



PL Statecznik elektroniczny
EN Electric driver
RU Электронный балласт
UK Електронний пусковий пристрій

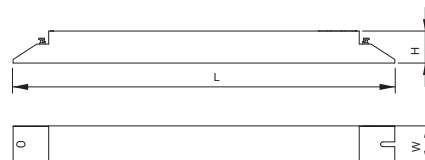

Folder	W	Weight	Material	LxWxH	Barcode
OS-NSEL258-00	2 x 58 W / T8	280 g	metal metal металл метал	322 x 31 x 27 mm	5902801281327
OS-NSEL236-00	2 x 36 W / T8	250 g			5902801281273
OS-NSEL218-00	2 x 18 W / T8	190 g			5902801281280
OS-NSEL158-00	58 W / T8	250 g		271 x 27 x 27 mm	5902801281266
OS-NSEL136-00	36 W / T8	200 g			5902801281655
OS-NSEL118-00	18 W / T8	180 g			5902801281879



PL Zasilacz DALI
EN DALI power supply unit
RU Блоки питания DALI
UK Блок живлення DALI

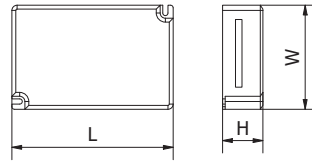

	CC	U OUTPUT	LxWxH mm		
BK-PUL030A-0700AD	250-700 mA	3-42V	104 x 68 x 31	170 g	5902801299377
BK-PUL042A-0700BD	250-700 mA	3-84V	104 x 68 x 21		5902801299483
BK-PUL042A-1100AD	600-1100 mA	3-42V	104 x 68 x 21		5902801299452
BK-PUL060A-2000AD	800-2000 mA	3-42V	124 x 80 x 31		5902801270758

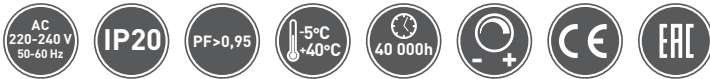

PL Zasilacz DALI
EN DALI power supply unit
RU Блоки питания DALI
UK Блок живлення DALI



	CC	U OUTPUT	LxWxH mm		
BK-BHL050-1000BZ	550-1000 mA	3-54V	355 x 30 x 21	300 g	5902801270741
BK-BHL060-1300BZ	850-1300 mA		285 x 30 x 21		5902801299537





PL Moduł awaryjny do paneli LED
 EN LED panel emergency module
 RU Аварийный модуль для светодиодной панели
 UK Аварійний модуль для світлодіодної панелі



					
OA-MALEDPAN-00	3 h	PC	biały, white, белый, білий	525 g	5902801285400

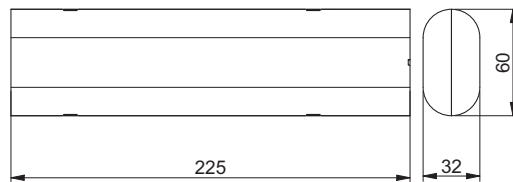

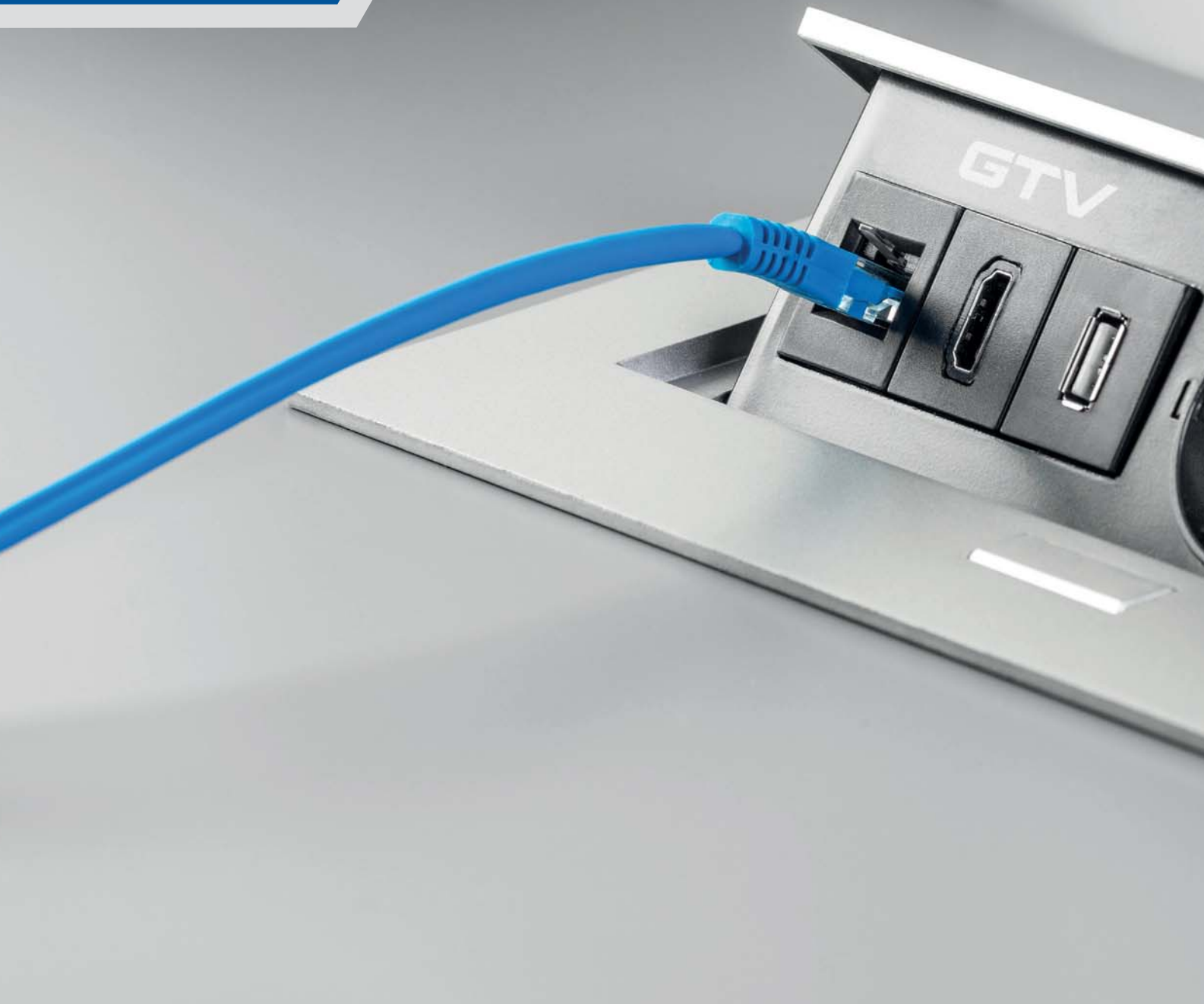



OŚWIETLENIE MEBLOWE / PROFILE LED

FURNITURE LIGHTING / LED PROFILES

ОСВЕЩЕНИЕ МЕБЕЛИ / ПРОФИЛИ ДЛЯ СВЕТОДИОДНЫХ ЛЕНТ

ОСВІТЛЕННЯ МЕБЛІВ / ПРОФІЛЬ ДЛЯ СВІТЛОДІОДНОЇ СТРИЧКИ

Taśmy LED / Profile LED LED strips / LED profiles Светодиодные ленты / Профили LED Стрічки LED / Профілі LED	297
Oprawy LED LED fixtures Светодиодные светильники Світлодіодні світильники	322
Aksesoria Accessories Аксессуары Аksesуари	342
Przedłużacze Power sockets Удлинитель Подовжувачн	370



ТАЅМУ LED / PROFILE LED
LED STRIPS / LED PROFILES
СВЕТОДИОДНЫЕ ЛЕНТЫ / ПРОФИЛИ LED
СТРІЧКИ LED / ПРОФІЛІ LED

PL Taśma LED FLASH
EN LED strip FLASH
RU Светодиодная лента FLASH
UK Світлодіодна стрічка FLASH



LD-3528-300-20-ZB	12 VDC 24 W	300 lm/m	● 6500 K	20	120°	8	60/m	5	5901867152053	
LD-3528-300-20-NE4P			● 4000 K						5902801224911	
LD-3528-300-20-CB			● 3200 K						5901867152022	
LD-3528-300-65-ZB		280 lm/m	● 6500 K	65					5901867152114	
LD-3528-300-65-CB			● 3200 K						5901867152084	
LD-3528-300-20-NI		-	niebieski / blue / синий / синій.						5901867198983	
LD-3528-600-20-ZB	12 VDC 48 W	550 lm/m	● 6500 K	20		120/m	2,5	5901867152251		
LD-3528-600-20-CB			● 3200 K					5901867152312		
LD-3528-600-65-ZB		520 lm/m	● 6500 K	65				5901867152374		
LD-3528-600-65-CB			● 3200 K					5901867152343		
LD-2835-300-20-ZB	12 VDC 30 W	750 lm/m	● 6500 K	20		120°	8	60/m	5	5901867152640
LD-2835-300-20-NE4P			● 4000 K							5902801224980
LD-2835-300-20-CB			● 3200 K		5901867152619					
LD-2835-300-65-ZB		700 lm/m	● 6500 K	65	5901867152701					
LD-2835-300-65-CB			● 3200 K		5901867152671					
LD-2835-300-20-ZBN			850 lm/m		● 6500 K					20
LD-2835-300-20-NE4N	● 4000 K	5902801285738								
LD-2835-300-20-CBN	● 3200 K	5902801285585								
LD-2835-300-65-ZBN	730 lm/m	● 6500 K		65	5902801285707					
LD-2835-300-65-NE4N		● 4000 K			5902801295386					
LD-2835-300-65-CBN		● 3200 K	5902801294785							
LD-2835-600-20-ZB	12 VDC 60 W	1600 lm/m	● 6500 K	20	10		120/m	2,5	5902801231933	
LD-2835-600-20-NE4			● 4000 K			5902801268700				
LD-2835-600-20-CB			● 3200 K			5902801231537				
LD-2835-600-65-ZB		1350 lm/m	● 6500 K	65		5902801231605				
LD-2835-600-65-CB			● 3200 K			5902801231360				





LD-2835-600-20-ZB	12 VDC 60 W	1600 lm/m	● 6500 K	20	120°	10	120/m	2,5	5902801231933	
LD-2835-600-20-NE4			● 4000 K						5902801268700	
LD-2835-600-20-CB			● 3200 K						5902801231537	
LD-2835-600-65-ZB		● 6500 K	5902801231605							
LD-2835-600-65-CB	● 3200 K	5902801231360								
LD-2835-600-5MM-20-ZB	12 VDC 33 W	750 lm/m	● 6500 K	20		5		8	5	5902801285448
LD-2835-600-5MM-20-NE4			● 4000 K							5902801285547
LD-2835-600-5MM-20-CB			● 3200 K							5902801285486
LD-2835-60-60-20-CCT	12 VDC 30 W	700 lm/m	● 3200 K ● 6500 K							5902801260292
LD-5050-300-20-ZB	12 VDC 72 W	900 lm/m	● 6500 K	65		10		60/m	5	5901867152497
LD-5050-300-20-CB			● 3200 K		5901867152466					
LD-5050-300-65-ZB		850 lm/m	● 6500 K		5901867152558					
LD-5050-300-65-CB			● 3200 K		5901867152527					
LD-5630-300-20-ZB	12 VDC 80 W	1750 lm/m	● 6500 K	20	10		60/m	5	5901867152763	
LD-5630-300-20-CB			● 3200 K						5901867152732	
LD-5630-300-65-ZB		1700 lm/m	● 6500 K						5901867152824	
LD-5630-300-65-CB			● 3200 K						5901867152794	
LD-3014-1200-20-ZB	12 VDC 53 W	1300 lm/m	● 6500 K	20		120°	240/m	1,25	5902801231766	
LD-3014-1200-20-NE4			● 4000 K						5902801232077	
LD-3014-1200-20-CB			● 3200 K						5902801267154	
LD-RGB-150-20	12 VDC 36 W	450 lm/m	● RGB	65			30/m	10	5901867152404	
LD-RGB-150-65					5901867152435					



PL Taśma LED FLASH
EN LED strip FLASH
RU Светодиодная лента FLASH
UK Світлодіодна стрічка FLASH



LD-2835-24V-300-20-CB	24 VDC 48 W	1100 lm/m	● 3200 K	20	120°	8 mm	60/m	10	5902801245633			
LD-2835-24V-300-20-ZB			● 6500 K						5902801245664			
LD-2835-24V-300-20-NE4			● 4000 K						5902801245787			
LD-2835-24V-600-20-CB	24 VDC 78 W	1900 lm/m	● 3200 K						10 mm	120/m	5	5902801245855
LD-2835-24V-600-20-ZB			● 6500 K									5902801245701
LD-2835-24V-600-20-NE4			● 4000 K									5902801245640



PL Taśma LED FLASH 50 m
EN LED strip FLASH 50 m
RU Светодиодная лента FLASH 50 m
UK Світлодіодна стрічка FLASH 50 m



LD-2835-300-20-ZB-50	12 VDC 6 W/m	750 lm/m	● 6500 K	20	120°	8 mm	60/m	5	5901867195142		
LD-2835-300-20-NE4P-50			● 4000 K						5902801225000		
LD-2835-300-20-CB-50			● 3200 K						5901867195128		
LD-3528-300-20-ZB-50	12 VDC 4,8 W/m	300 lm/m	● 6500 K						3200 K	5901867172099	
LD-3528-300-20-NE4P-50			● 4000 K								5902801252150
LD-3528-300-20-CB-50			● 3200 K								5901867172082



PL Profil GLAX liniowy
EN GLAX linear profile
RU Профиль GLAX линейный
UK Профіль GLAX лінійний

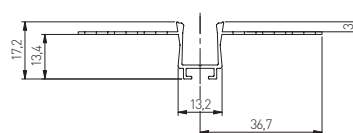
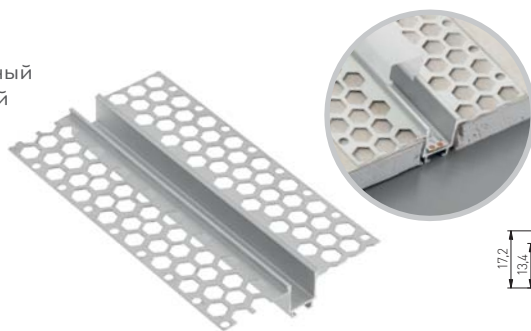

Code	Length (m)	Description	Material	Material	Barcode
PA-GLAXGKL3M-00	3	profil, profile, профиль, профіль		aluminium, aluminium, алюминий, алюміній	5902801206832
PA-CPGLAXL-00	-	łącznik liniowy, straight connector, линейный соединитель, з'єднувач, лінійний	srebrny, silver, серебристый, срібний	stal nierdzewna, stainless steel, нержавеющей сталь, нержавіюча сталь.	5902801295430
PA-CPGLAXAH-00	-	łącznik poziomy, horizontal connector, горизонтальный соединитель, з'єднувач, горизонтальний			5902801295300
PA-CPGLAXAV-00	-	łącznik pionowy, vertical connector, вертикальный соединитель, з'єднувач, вертикальный			5902801295317
PA-OSMLGLAXM3M-00	3	osłonka, cover, крышка, кришка	mleczna, frosted, молочная, молочный	PC	5902801024047
PA-OSMLGLAXMK3M-00	3	osłonka kwadratowa, square cover, крышка квадратная, крышка квадратна			5902801273926
PA-OSMLGLAXMO3M-00	3	osłonka okrągła, round cover, крышка круглая, крышка круга			5902801274152
PA-OSMLGLAXT3M-00	3	osłonka trójkątna, triangular cover, крышка треугольная, крышка трикутна			5902801274084

Ostonki / Covers / Крышки / Кришки:

Akcesoria / Accessories / Аксессуары / Аксесуари:



PL Profil GLAX ścienny
EN GLAX wall profile
RU Профиль GLAX настенный
UK Профіль GLAX настінний

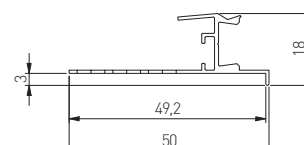

Code	Length (m)	Description	Material	Material	Barcode
PA-GLAXGKS3M-00	3	profil, profile, профиль, профіль		aluminium, aluminium, алюминий, алюміній	5902801206702
PA-CPGLAXL-00	-	łącznik liniowy, straight connector, линейный соединитель, з'єднувач, лінійний	srebrny, silver, серебристый, срібний	stal nierdzewna, stainless steel, нержавеющей сталь, нержавіюча сталь.	5902801295430
PA-CPGLAXAH-00	-	łącznik poziomy, horizontal connector, горизонтальный соединитель, з'єднувач, горизонтальний			5902801295300
PA-CPGLAXAV-00	-	łącznik pionowy, vertical connector, вертикальный соединитель, з'єднувач, вертикальный			5902801295317
PA-OSMLGLAXM3M-00	3	osłonka, cover, крышка, кришка	mleczna, frosted, молочная, молочный	PC	5902801024047
PA-OSMLGLAXMK3M-00	3	osłonka kwadratowa, square cover, крышка квадратная, крышка квадратна			5902801273926
PA-OSMLGLAXMO3M-00	3	osłonka okrągła, round cover, крышка круглая, крышка круга			5902801274152
PA-OSMLGLAXT3M-00	3	osłonka trójkątna, triangular cover, крышка треугольная, крышка трикутна			5902801274084

Ostonki / Covers / Крышки / Кришки:

Akcesoria / Accessories / Аксессуары / Аксесуари:



PL Profil GLAX sufitowy
EN GLAX ceiling profile
RU Профиль GLAX потолочный
UK Профіль GLAX стельовий

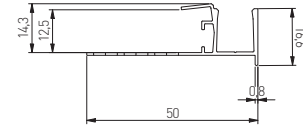
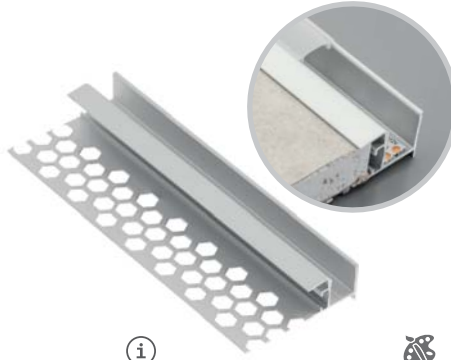

PA-GLAXGKW3M-00	3	profil, profile, профиль, профіль	srebrny, silver, серебристый, срібний	aluminium, aluminium, алюминий, алюміній	5902801206702
PA-CPGLAXL-00	-	łącznik liniowy, straight connector, линейный соединитель, з'єднувач, лінійний			5902801295430
PA-CPGLAXAH-00	-	łącznik poziomy, horizontal connector, горизонтальный соединитель, з'єднувач, горизонтальный			5902801295300
PA-CPGLAXAV-00	-	łącznik pionowy, vertical connector, вертикальный соединитель, з'єднувач, вертикальный			5902801295317
PA-OSMLGLAXM3M-00	3	osłonka, cover, крышка, кришка	mleczna, frosted, молочная, молочний	PC	5902801024047
PA-OSMLGLAXMK3M-00	3	osłonka kwadratowa, square covere, крышка квадратная, кришка квадратна			5902801273926
PA-OSMLGLAXMO3M-00	3	osłonka okrągła, round cover, крышка круглая, кришка кругла			5902801274152
PA-OSMLGLAXT3M-00	3	osłonka trójkątna, triangular cover, крышка треугольная, кришка трикутна			5902801274084

Ostonki / Covers / Крышки / Кришки:

Aksesoria / Accessories / Аксессуары / Аксесуари:



PA-OSMLGLAXM3M-00 PA-OSMLGLAXMK3M-00 PA-OSMLGLAXMO3M-00 PA-OSMLGLAXT3M-00

PA-CPGLAXL-00 PA-CPGLAXAH-00 PA-CPGLAXAV-00

PL Profil GLAX kątowy, wewnętrzny
EN GLAX internal angle profile
RU Профиль GLAX угловой внутренний
UK Профіль GLAX кутовий, внутрішній

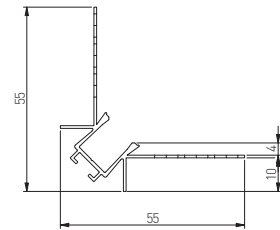

PA-GLAXGKW3M-00	3	profil, profile, профиль, профіль	srebrny, silver, серебристый, срібний	aluminium, aluminium, алюминий, алюміній	5902801207006
PA-CPGLAXL-00	-	łącznik liniowy, straight connector, линейный соединитель, з'єднувач, лінійний			5902801295430
PA-CPGLAXAH-00	-	łącznik poziomy, horizontal connector, горизонтальный соединитель, з'єднувач, горизонтальный			5902801295300
PA-CPGLAXAV-00	-	łącznik pionowy, vertical connector, вертикальный соединитель, з'єднувач, вертикальный			5902801295317
PA-OSMLGLAXM3M-00	3	osłonka, cover, крышка, кришка	mleczna, frosted, молочная, молочний	PC	5902801024047
PA-OSMLGLAXMK3M-00	3	osłonka kwadratowa, square covere, крышка квадратная, кришка квадратна			5902801273926
PA-OSMLGLAXMO3M-00	3	osłonka okrągła, round cover, крышка круглая, кришка кругла			5902801274152
PA-OSMLGLAXT3M-00	3	osłonka trójkątna, triangular cover, крышка треугольная, кришка трикутна			5902801274084

Ostonki / Covers / Крышки / Кришки:

Aksesoria / Accessories / Аксессуары / Аксесуари:



PA-OSMLGLAXM3M-00 PA-OSMLGLAXMK3M-00 PA-OSMLGLAXMO3M-00 PA-OSMLGLAXT3M-00

PA-CPGLAXL-00 PA-CPGLAXAH-00 PA-CPGLAXAV-00

PL Profil GLAX kątowy, zewnętrzny
EN GLAX external angle profile
RU Профиль GLAX угловой внешний
UK Профіль GLAX кутовий, зовнішній

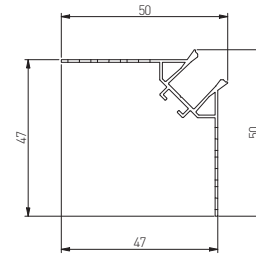
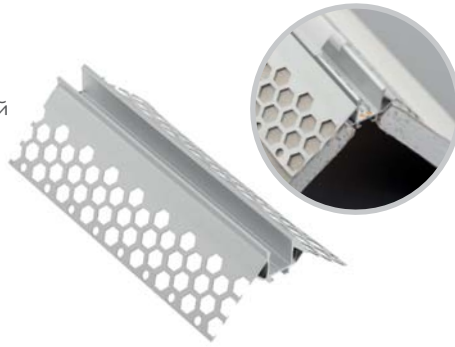

PA-GLAXGKZK3M-00	3	profil, profile, профиль, профіль	srebrny, silver, серебристый, срібний	aluminium, aluminium, алюминий, алюміній	5902801207105
PA-CPGLAXL-00	-	łącznik liniowy, straight connector, лінійний з'єднувач, з'єднувач, лінійний		stal nierdzewna, stainless steel, нержавеющей сталь, нержавіюча сталь.	5902801295430
PA-CPGLAXAH-00	-	łącznik poziomy, horizontal connector, горизонтальный з'єднувач, з'єднувач, горизонтальный		5902801295300	
PA-CPGLAXAV-00	-	łącznik pionowy, connector vertical, вертикальный з'єднувач, з'єднувач, вертикальный		5902801295317	
PA-OSMLGLAXM3M-00	3	osłonka, cover, крышка, кришка	mleczna, frosted, молочная, молочний	PC	5902801024047
PA-OSMLGLAXMK3M-00	3	osłonka kwadratowa, square cover, крышка квадратная, кришка квадратна			5902801273926
PA-OSMLGLAXMO3M-00	3	osłonka okrągła, round cover, крышка круглая, кришка кругла			5902801274152
PA-OSMLGLAXT3M-00	3	osłonka trójkątna, triangular cover, крышка треугольная, кришка трикутна			5902801274084

Oslonki / Covers / Крышки / Кришки:

Aksesoria / Accessories / Аксессуары / Аксессуары:



PA-OSMLGLAXM3M-00 PA-OSMLGLAXMK3M-00 PA-OSMLGLAXMO3M-00 PA-OSMLGLAXT3M-00



PA-CPGLAXL-00 PA-CPGLAXAH-00 PA-CPGLAXAV-00



PL Profil GLAX nakładany, mikro
EN GLAX profile surface mounted, micro
RU Профиль GLAX накладной, микро
UK Профіль GLAX накладний, мікро

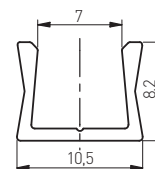
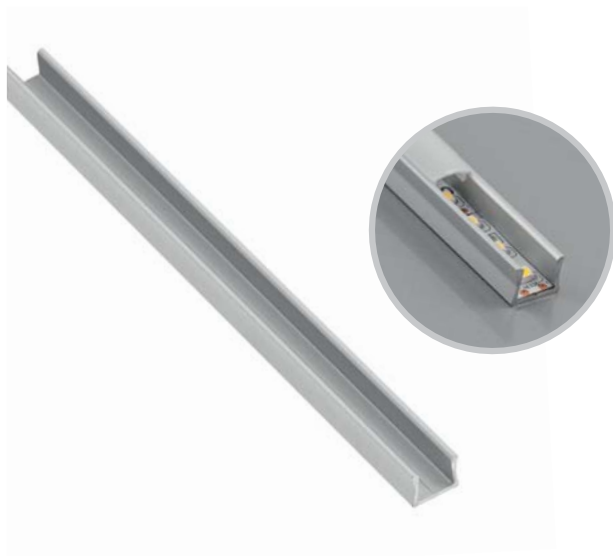

Wąska linia światła,
Brak punktów świetlnych przy użyciu
dedykowanej taśmy LED o szerokości 5 mm
Narrow line of light.
No visible points of light due to dedicated 5mm LED strip
Узкая линия света.
Отсутствуют пункты свечения при использовании
специальной ленты LED шириной 5 мм
Вузька лінія світла,
Відсутність світлових точок при використанні
призначеної стрічки LED шириною 5 мм

PA-GLAXMICNK-AL	2	profil, profile, профиль, профіль	srebrny, silver, серебристый, срібний	aluminium, aluminium, алюминий, алюміній	5902801281549
PA-GLAXMICNK3M-AL	3				5902801281495
PA-OSMLGLAXMIC-00	2	osłonka mikro, cover micro, крышка микро, мікрокришка	mleczna, frosted, молочная, молочний	PC	5902801292804
PA-OSMLGLAXMIC3M-00	3				5902801292873
PA-ZASGLAXMICNK-00	-	zaślepka, end cap, заглушка, кінцевий ковпачок	szary, gray, серый, сірий	ABS	5902801200274
PA-SPRGLAXMIC-00	-	uchwyt, mounting clip, держатель, ручка,	srebrny, silver, серебристый, срібний	Stal nierdzewna, stainless steel, нержавеющей сталь, нержавіюча сталь.	5902801244711

Ostonki / Covers / Крышки / Кришки:



PA-OSMLGLAXMIC-00

Zaślepki / End caps / Заглушки / Кінцеві ковпачки:



PA-ZASGLAXMICNK-00

Uchwyt, mounting clip, держатель, кліпса монтажна,



PA-SPRGLAXMIC-00



PL Profil GLAX nakładany mini
EN GLAX profile mini surface mounted
RU Профиль GLAX накладной мини
UK Профіль GLAX накладний, mini

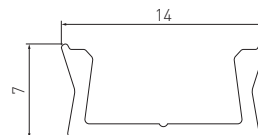

Taśma LED max 10 mm szerokości
LED strip width max 10 mm
Ширина светодиодной ленты не более 10 мм
Стрічка LED максимум 10 мм шириною

Product Code	Quantity	Description	Color	Material	Barcode
PA-GLAXMNK-AL	2	profil, profile, профиль, профіль	srebrny, silver, серебристый, срібний	aluminium, aluminium, алюминий, алюміній	5902801010316
PA-GLAXMNK-AL-20M			czarny, black, черный, чорний		5902801256660
PA-GLAXMNK-AL-10			biały, white, белый, білий		5902801256684
PA-GLAXMNK-AL-90			szampan, champagne, шампань, шампань		5902801256738
PA-GLAXMNK3M-AL	3	profil, profile, профиль, профіль	srebrny, silver, серебристый, срібний	aluminium, aluminium, алюминий, алюміній	5902801010781
PA-GLAXMNK3M-AL-20M			czarny, black, черный, чорний		5902801255854
PA-GLAXMNK3M-AL-10			biały, white, белый, білий		5902801255779
PA-OSMLGLAXM-00	2	osłonka mini, cover mini, крышка мини, мінікришка	mleczna, frosted, молочная, молочний	PC	5902801024023
PA-OSMLGLAXM3M-00	3		transparentna, transparent, прозрачная, прозорий		5902801024047
PA-OSTRGLAXM-00	2		transparentna, transparent, прозрачная, прозорий		5902801024030
PA-OSTRGLAXM3M-00	3		transparentna, transparent, прозрачная, прозорий		5902801024054
PA-OSMLGLAXMK-00	2	osłonka kwadratowa, square cover, крышка квадратная, кришка квадратна	mleczna, frosted, молочная, молочний	PC	5902801040511
PA-OSMLGLAXMO-00		osłonka okrągła, round cover, крышка круглая, кришка круглая	mleczna, frosted, молочная, молочний		5902801222702
PA-ZASGLAXMNK-00	-	zaślepka standard, standard end cap, заглушка стандартная, кінцевий ковпачок стандартний	szary, gray, серый, сірий	ABS	5902801024061
PA-ZASGLAXMNK-10			biały, white, белый, білий		5902801241536
PA-ZASGLAXMNK-90			szampan, champagne, шампань, шампань		5902801245084
PA-ZASGLAXMNK-20M			czarny mat, black matt, чёрный матовый, чорний матовый		5902801245268
PA-ZASGLAXMKNK-00	-	zaślepka kwadratowa, square end cap, заглушка квадратная, кінцевий ковпачок квадратный	szary, gray, серый, сірий	ABS	5902801222962
PA-ZASGLAXMNKO-00	-	zaślepka okrągła, round end cap, заглушка круглая, кінцевий ковпачок круглый	szary, gray, серый, сірий		5902801222986
PA-SPRGLAXM-00	-	uchwyt, mounting clip, держатель, ручка,	srebrny, silver, серебристый, срібний	stal nierdzewna, stainless steel, нержавеющей сталь, нержавіюча сталь.	5902801244711

Ostonki / Covers / Крышки / Кришки:



PA-OSMLGLAXM-00 PA-OSMLGLAXM3M-00 PA-OSTRGLAXM-00 PA-OSTRGLAXM3M-00 PA-OSMLGLAXMO-00 PA-OSMLGLAXMK-00

Zaślepki / End caps / Заглушки / Кінцеві ковпачки:



PA-ZASGLAXMNK-00 PA-ZASGLAXMKNK-00 PA-ZASGLAXMNKO-00 PA-SPRGLAXM-00

Uchwyt, mounting clip, держатель, кліпса монтажна,

PL Profil GLAX nakładany
EN GLAX profile surface mounted
RU Профиль GLAX накладной
UK Профіль GLAX накладний

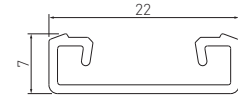

PA-GLAXNK-AL	2	profil, profile, профиль, профіль	srebrny, silver, серебристый, срібний	aluminium, aluminium, алюминий, алюміній	5901867127037	
PA-GLAXNK3M-AL	3				5901867196606	
PA-OSMLGLAXM-00	2	oslonka mini, cover mini, крышка мини, мінікришка	mleczna, frosted, молочная, молочний	PC	5902801024023	
PA-OSMLGLAXM3M-00	3				5902801024047	
PA-OSTRGLAXM-00	2				transparentna, transparent, прозрачная, прозорий	5902801024030
PA-OSTRGLAXM3M-00	3					5902801024054
PA-ZASGLAXNK-00	-	zaślepka, end cap, заглушка, кінцевий ковпачок	szary, gray, серый, сірий	ABS	5901867136411	

Ostonki / Covers / Крышки / Кришки:

Zaślepki / End caps / Заглушки / Кінцеві ковпачки:



PA-OSMLGLAX-00
PA-OSMLGLAX3M-00



PA-OSTRGLAX-00
PA-OSTRGLAX3M-00



PA-ZASGLAXNK-00



PL Profil GLAX nakładany mini, wysoki
 EN Profile GLAX surface mounted mini, high
 RU Профиль GLAX накладной мини, высокий
 UK Профіль GLAX накладний, міні, високий

Brak widocznych punktów świetlnych
 Taśma LED max 10 mm szerokości
 No visible points of light
 LED strip width max 10 mm
 Нет видимых точек света
 Ширина светодиодной ленты не более 10 мм
 Відсутність видимих світлових точок
 Стрічка LED максимум 10 мм шириною.

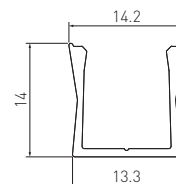

PA-GLAXMNKW-AL					5902801027468	
PA-GLAXMNKW-AL-20M		2	profil, profile, профиль, профіль	srebrny, silver, серебристый, срібний	aluminium, aluminium, алюміній, алюміній	5902801256929
PA-GLAXMNKW-AL-10	biały, white, белый, білий			5902801256851		
PA-GLAXMNKW-AL-90	szampan, champagne, шампань, шампань			5902801256813		
PA-OSMLGLAXM-00	2			osłonka mini, cover mini, крышка мини, мінікришка		mleczna, frosted, молочная, молочный
PA-OSTRGLAXM-00		transparentna, transparent, прозрачная, прозорий	5902801024030			
PA-ZASGLAXMKNW-00		-	zaślepka, end cap, заглушка, кінцевий ковпачок	szary, gray, серый, сірий	ABS	5902801223181
PA-ZASGLAXMKNW-10	biały, white, белый, білий			5902801241857		
PA-ZASGLAXMKNW-90	szampan, champagne, шампань, шампань			5902801241543		
PA-ZASGLAXMKNW-20M	czarny mat, black matt, чёрный матовый, чорний матовий			5902801241802		
PA-SPRGLAXM-00		-	uchwyt, mounting clip, держатель, ручка,	srebrny, silver, серебристый, срібний	stal nierdzewna, stainless steel, нержавеющая сталь, нержавіюча сталь.	5902801244711

Ostonki / Covers / Крышки / Кришки:

Zaślepka / End cap / Заглушка / кінцевий
ковпачок:

Uchwyt / mounting clip / держатель / ручка



PA-OSMLGLAXM-00

PA-OSTRGLAXM-00



PA-ZASGLAXMKNW-00



PA-SPRGLAXM-00

PL Profil GLAX wpuszczany, mikro
EN GLAX profile recessed, micro
RU Профиль GLAX врезной, микро
UK Профіль GLAX врізний, мікро

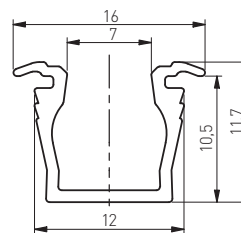

Wąska linia światła,
Brak punktów świetlnych przy użyciu
dedykowanej taśmy LED o szerokości 5 mm
Narrow line of light.
No visible points of light due to dedicated
5mm LED strip
Узкая линия света.
Відсутність видимих світлових точок
Стрічка LED 5 мм шириною.

PA-GLAXMIC-AL	2	profil, profile, профиль, профіль	srebrny, silver, сребристый, срібний	aluminium, aluminium, алюминий, алюміній	5902801281600
PA-GLAXMIC3M-AL	3				5902801281839
PA-OSMLGLAXMIC-00	2	osłonka mikro, cover micro, крышка микро, мікрокришка	mleczna, frosted, молочная, молочний	PC	5902801292804
PA-OSMLGLAXMIC3M-00	3				5902801292873
PA-ZASGLAXMIC-00	-	zaślepka, end cap, заглушка, кінцевий ковпачок	szary, gray, серый, сірий	ABS	5902801200205

Ostonki / Covers / Крышки / Кришки:



PA-OSMLGLAXMIC-00

Zaślepka / End cap / Заглушка / кінцевий ковпачок:



PA-ZASGLAXMIC-00

PL Profil GLAX wpuszczany
EN Profile GLAX recessed
RU Профиль LED GLAX врезной
UK Профіль GLAX врізний

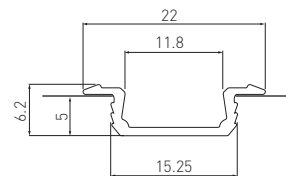

PA-GLAX-AL	2	profil, profile, профиль, профіль	srebrny, silver, серебристый, срібний	aluminium, aluminium, алюминий, алюміній	5901867111975
PA-GLAX-AL-20M			czarny, black, черный, чорний		5902801256431
PA-GLAX-AL-10			biały, white, белый, білий		5902801256691
PA-GLAX-AL-90			szampan, champagne, шампань, шампань		5902801256639
PA-GLAX3M-AL			3		srebrny, silver, серебристый, срібний
PA-OSMLGLAX-00	2	osłonka, cover, крышка, кришка	mleczna, frosted, молочная, молочний	PC	5901867111999
PA-OSMLGLAX3M-00	3		transparentna, transparent, прозрачная, прозорий		5901867197610
PA-OSTRGLAX-00	2		transparentna, transparent, прозрачная, прозорий		5901867112002
PA-OSTRGLAX3M-00	3		transparentna, transparent, прозрачная, прозорий		5901867197627
PA-ZASGLAX-00	-	zaślepka, end cap, заглушка, кінцевий ковпачок	szary, gray, серый, сірий	ABS	5901867111982
PA-ZASGLAX-10			biały, white, белый, білий		5902801245145
PA-ZASGLAX-90			szampan, champagne, шампань, шампань		5902801245169
PA-ZASGLAX-20M			czarny mat, black matt, чёрный матовый, чорний матовий		5902801244674

Ostonki / Covers / Крышки / Кришки:

Zaślepka / End cap / Заглушка / кінцевий ковпачок:



PA-OSMLGLAX-00
PA-OSMLGLAX3M-00



PA-OSTRGLAX-00
PA-OSTRGLAX3M-00

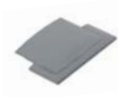

PA-ZASGLAX-00

PL Profil GLAX wpuszczany, wysoki
EN Profile GLAX recessed, high
RU Профиль LED GLAX врезной
UK Профіль GLAX врізний, високий

Brak widocznych punktów świetlnych
Taśma LED max 10 mm szerokości
No visible points of light
LED strip width max 10 mm

Нет видимых точек света
Ширина светодиодной ленты не более 10 мм
Відсутність видимих світлових точок
Стрічка LED максимум 10 мм шириною

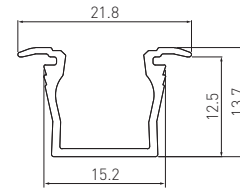

Icon: Folder	Icon: L	Icon: i	Icon: Leaf	Icon: Cube	Icon: Barcode
PA-GLAXMW-AL	2	profil, profile, профиль, профіль	srebrny, silver, серебристый, срібний	aluminium, aluminium, алюминий, алюміній	5902801027475
PA-GLAXMW-AL-20M			czarny, black, черный, чорний		5902801256967
PA-GLAXMW-AL-10			biały, white, белый, білий		5902801256622
PA-GLAXMW-AL-90			szampan, champagne, шампань, шампань		5902801257049
PA-OSMLGLAXM-00	2	osłonka mini, cover mini, крышка мини, мінікришка	mleczna, frosted, молочная, молочный	PC	5902801024023
PA-OSMLGLAXMK-00		osłonka kwadratowa, square cover, крышка квадратная, кришка квадратна			5902801040511
PA-OSTRGLAXM-00		osłonka mini, cover mini, крышка мини, мінікришка	transparentna, transparent, прозрачная, прозрачный		5902801024030
PA-ZASGLAXMW-00	-	zaślepka standard, standard end cap, заглушка стандартная, кінцевий ковпачок стандартний	szary, gray, серый, сірий	ABS	5902801040481
PA-ZASGLAXMW-10			biały, white, белый, білий		5902801241635
PA-ZASGLAXMW-90			szampan, champagne, шампань, шампань		5902801242090
PA-ZASGLAXMW-20M			czarny mat, black matt, чёрный матовый, чорний матовый		5902801241628
PA-ZASGLAXMWK-00	-	zaślepka kwadratowa, square end cap, заглушка квадратная, кінцевий ковпачок квадратный	szary, gray, серый, сірий		5902801040559

Osłonki / Covers / Крышки / Кришки:



PA-OSMLGLAXM-00 PA-OSTRGLAXM-00 PA-OSMLGLAXMK-00

Zaślepka / End cap / Заглушка / кінцевий ковпачок:



PA-ZASGLAXMW-00 PA-ZASGLAXMWK-00

PL Profil GLAX drążkowy
EN GLAX rail profile
RU Профиль-штанга GLAX
UK Профіль GLAX штанговий

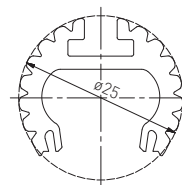

Możliwość montażu jako, assembly options as, варианты сборки как, Можливість установки як

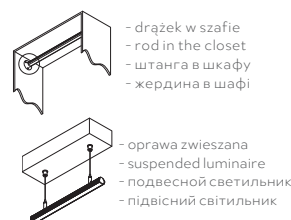

PA-GLAXDR-AL		profil, profile, профиль, профіль	srebrny, silver, серебристый, срібний	aluminium, aluminium, алюминий, алюміній	5902801258954
PA-OSMLGLAX-00	2	osłonka, cover, крышка, кришка	mleczna, frosted, молочная, молочный	PC	5901867111999
PA-OSTRGLAX-00			transparentna, transparent, прозрачная, прозорий		5901867112002
PA-ZASGLAXDR-00	-	zaślepka, end cap, заглушка, кінцевий ковпачок	szary, gray, серый, сірий	ZnAl	5902801223266
PA-ROZGLAX-53	-	rozetka, rail socket, монтажный крепеж, Розетка,			5902801018046
PA-ROZGLAXP-53	-	rozetka PREMIUM			5902801226359
PA-ZAWGLAXDR-00	1,5	zawieszka, hanger, подвес для профиля, підвіска	chrom, chrome, хром, хром	stal, steel, сталь, сталь	5902801046506

Ostonki / Covers / Крышки / Кришки:



PA-OSMLGLAX-00

PA-OSTRGLAX-00

Zaślepka / End cap / Заглушка / кінцевий ковпачок:



PA-ZASGLAXDR-00

Rozetka / Rail socket / Монтажный крепеж / Розетка:



PA-ROZGLAX-53



PA-ROZGLAXP-53

Zawieszka / Hanger / Подвес для профиля / Підвіска:



PA-ZAWGLAXDR-00

PL Profil GLAX z radiatorem
EN Profile GLAX with heatsink
RU Профиль GLAX с радиатором
UK Профіль GLAX з радіатором

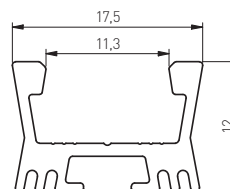

Dedykowana soczewka zawężająca kąt świecenia do 60°.
Możliwość zawieszenia oprawy za pomocą linek
Dedicated lens that narrows the beam angle to 60 degrees
Possibility to suspend the fixture using lines
Специальная линза, сужающая угол свечения до 60 градусов
Возможность монтажа с помощью крепления-тросика
Призначена линза, яка звужує кут освітлення до 60°.
Можливість підвішування світильника за допомогою кабелів

PA-GLAXRAD-AL	2	profil, profile, профиль, профіль	srebrny, silver, серебристый, срібний	aluminium, aluminium, алюминий, алюміній	5902801281877
PA-OSMLGLAXSO-00	2	osłonka soczewka, cover lenticular, крышка линзовидный, кришка лінза	transparentna, transparent, прозрачная, прозорий	PMMA	5902801293153
PA-OSMLGLAX-00	2	osłonka, cover, крышка, кришка	mleczna, frosted, молочная, молочный	PC	5901867111999
PA-OSTRGLAX-00			transparentna, transparent, прозрачная, прозорий		5901867112002
PA-ZASGLAXRAD-00	-	zaślepka, end cap, заглушка, кінцевий ковпачок	szary, gray, серый, сірий	ABS	5902801200373
PA-ZAWGLAXDR-00	1,5	zawieszka, hanger, подвес для профиля, підвіска	chrom, chrome, хром, хром	stal, steel, сталь, сталь	5902801046506
PA-SPRGLAXM-00	-	uchwyt, mounting clip, держатель, ручка	srebrny, silver, серебристый, срібний	stal nierdzewna, stainless steel, нержавеющей сталь, нержавіюча сталь.	5902801244711

Oslonki / Covers / Крышки / Кришки:



PA-OSMLGLAXSO-00

PA-OSMLGLAX-00

PA-OSTRGLAX-00

Uchwyt / mounting clip / держатель / монтажнв кліпса::



PA-SPRGLAXM-00

Zawieszka / Hanger / Подвес для профиля / Підвіска::



PA-ZAWGLAXDR-00

PL Profil GLAX wieńcowy
EN Rim profile GLAX
RU Профиль GLAX, торцевой
UK Профіль GLAX торцевий

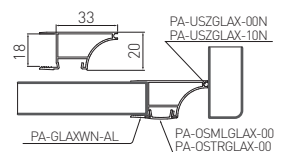

Icon: Folder	Icon: BOARD mm	Icon: L m	Icon: i	Icon: Leaf	Icon: Cube	Icon: Barcode
PA-GLAXWN-AL	18	2	profil, profile, профиль, профіль	srebrny, silver, серебристый, срібний	aluminium, aluminium, алюминий, алюміній	5902801258619
PA-GLAXWN16-AL	16					5902801210969
PA-GLAXWN19-AL	19					5902801210723
PA-OSMLGLAX-00	-	2	oslonka, cover, крышка, кришка	mleczna, frosted, молочная, молочный	PC	5901867111999
PA-OSTRGLAX-00	-			transparentna, transparent, прозрачная, прозорий		5901867112002
PA-USZGLAX-00N	-	10	uszczelka, cord gasket, уплотнитель, прокладка	czarny, black, черный, чорний	EPDM	5902801021039
PA-USZGLAX-10N	-			biały, white, белый, білий		5902801297502

Oslonki / Covers / Крышки / Кришки:



Uszczelka / Cord gasket / Уплотнитель / прокладка:



PL Profil GLAX kątowy, nakładany
EN GLAX aluminium corner profile – surface mounted
RU Профиль LED GLAX угловой, накладной
UK Профіль LED GLAX кутювий, накладний

meble
2019 **plus**
PRODUKT ROKU

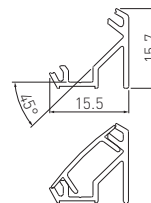

PA-GLAXNKKT-AL	2	profil, profile, профиль, профіль	srebrny, silver, серебристый, срібний	aluminium, aluminium, алюминий, алюміній	5901867199089
PA-GLAXNKKT-AL-20M			czarny, black, черный, чорний		5902801256721
PA-GLAXNKKT-AL-10			biały, white, белый, білий		5902801259647
PA-GLAXNKKT-AL-90			szampan, champagne, шампань, шампань		5902801256868
PA-GLAXNKKT3M-AL	3		srebrny, silver, серебристый, срібний		5901867199072
PA-OSMLGLAX-00	2	osłonka, cover, крышка, кришка	mleczna, frosted, молочная, молочний	PC	5901867111999
PA-OSMLGLAX3M-00	3				5901867197610
PA-OSTRGLAX-00	2		transparentna, transparent, прозрачная, прозрачный		5901867112002
PA-OSTRGLAX3M-00	3				5901867197627
PA-OSMLGLAXT-00	2	osłonka trójkątna, triangular cover, крышка треугольная, кришка трикутна	mleczna, frosted, молочная, молочний		5902801040627
PA-ZASGLAXNKKT-00	-	zaślepka standard, end cap standard, заглушка стандартная, кінцевий ковпачок стандартний	szary, gray, серый, сірий	ABS	5902801222900
PA-ZASGLAXNKKT-10			biały, white, белый, білий		5902801241734
PA-ZASGLAXNKKT-90			szampan, champagne, шампань, шампань		5902801245152
PA-ZASGLAXNKKT-20M		czarny mat, black matt, чёрный матовый, чорний матовый	5902801244476		
PA-ZASGLAXNKKT-00		zaślepka trójkątna, end cap triangular, заглушка треугольная, кінцевий ковпачок трикутна	szary, gray, серый, сірий		5902801223136
PA-SPRGLAXMIC-00	-	uchwyt, mounting clip, держатель, ручка,	srebrny, silver, серебристый, срібний	stal nierdzewna, stainless steel, нержавеющей сталь, нержавіюча сталь.	5902801244711

Ostonki / Covers / Крышки / Кришки:



Zaślepki / End caps / Заглушки / Кінцеві ковпачки:



PL Profil GLAX półkowy mini
EN Shelf profile GLAX mini
RU Профиль GLAX полочный мини
UK Профіль GLAX для полиць, міні



Możliwość zastosowania 3 taśm LED
Possibility of using 3 LED strips
Возможность использования 3 светодиодных лент
Можливість використання 3 стрічок LED

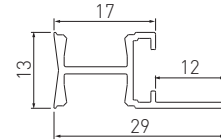
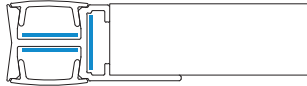

Folder	Length (m)	Info	Material	Material	Barcode
PA-GLAXMPK-AL	2	profil, profile, профиль, профіль	srebrny, silver, серебристый, срібний	aluminium, aluminium, алюминий, алюміній	5902801258633
PA-OSMLGLAXM-00		oslonka mini, cover mini, крышка мини, мінікришка	mleczna, frosted, молочная, молочный	PC	5902801024030
PA-OSTRGLAXM-00		transparentna, transparent, прозрачная, прозрачный	5902801024023		

Ostonki / Covers / Крышки / Кришки:



PA-OSMLGLAXM-00



PA-OSTRGLAXM-00

PL Profil GLAX, z regulowanym kątem świecenia
EN Aluminium Profile LED with adjustable angle
RU Профиль LED GLAX с регулировкой угла свечения
UK Профіль GLAX з регулюванням кута світіння

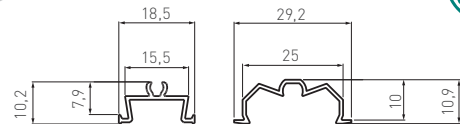

Folder	Length (m)	Info	Material	Material	Barcode
PA-GLAXREG1-AL	2	profil, profile, профиль, профіль	srebrny, silver, серебристый, срібний	aluminium, aluminium, алюминий, алюміній	5902801257773
PA-GLAXREG2-AL					5902801257797
PA-OSMLGLAX-00	2	oslonka mini, cover mini, крышка мини, мінікришка	mleczna, frosted, молочная, молочный	PC	5901867111999
PA-OSTRGLAX-00					transparentna, transparent, прозрачная, прозрачный

Ostonki / Covers / Крышки / Кришки:



PA-OSMLGLAX-00



PA-OSTRGLAX-00



PL Profil GLAX cokołowy jednostronny
EN GLAX aluminium edge profile – single-sided
RU Профиль LED GLAX торцевой, односторонний
UK Профіль GLAX цокольний, односторонній

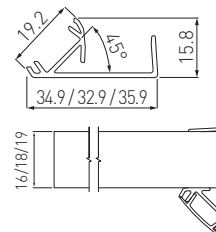

PA-GLAXNB3M16-AL	16	3	profil, profile, профиль, профіль	srebrny, silver, серебристый, срібний	aluminium, aluminium, алюминий, алюміній	5902801257834
PA-GLAXNB3M-AL	18	3				5902801258626
PA-GLAXNB3M19-AL	19	3				5902801257605
PA-OSMLGLAX3M-00	-	3	oslonka, cover, крышка, кришка	mleczna, frosted, молочная, молочний	PC	5901867197610
PA-OSTRGLAX3M-00	-	3				transparentna, transparent, прозрачная, прозорий

Oslonki / Covers / Крышки / Кришки:



PA-OSMLGLAX-00
PA-OSMLGLAX3M-00



PA-OSTRGLAX-00
PA-OSTRGLAX3M-00

PL Profil GLAX cokołowy jednostronny, do wypełnienia obrzeżem
EN GLAX aluminium edge profile – single-sided, option to fill with matching edge banding
RU Профиль LED GLAX торцевой, односторонний, кромочный, двухсторонний
UK Профіль GLAX цокольний, односторонній, для заповнення крайкою

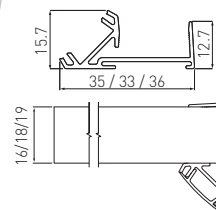

PA-GLAXNB3M16-AL	16	3	profil, profile, профиль, профіль	srebrny, silver, серебристый, срібний	aluminium, aluminium, алюминий, алюміній	5902801259036
PA-GLAXNB3M-AL	18	3				5902801258657
PA-GLAXNB3M19-AL	19	3				5902801258978
PA-OSMLGLAX3M-00	-	3	oslonka, cover, крышка, кришка	mleczna, frosted, молочная, молочний	PC	5901867197610
PA-OSTRGLAX3M-00	-	3				transparentna, transparent, прозрачная, прозорий

Oslonki / Covers / Крышки / Кришки:



PA-OSMLGLAX-00
PA-OSMLGLAX3M-00



PA-OSTRGLAX-00
PA-OSTRGLAX3M-00

PL Profil GLAX przegrodowy dwustronny
EN GLAX aluminium edge profile – double sided
RU Профиль LED GLAX разделительный, двухсторонний
UK Профіль GLAX перегородковий, двосторонній

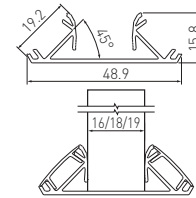

PA-GLAXNBD3M16-AL	16	3	profil, profile, профиль, профіль	srebrny, silver, серебристый, срібний	aluminium, aluminium, алюминий, алюміній	5902801259012
PA-GLAXNBD3M-AL	18	3				5902801258640
PA-GLAXNBD3M19-AL	19	3				5902801257650
PA-OSMLGLAX3M-00	-	3	oslonka, cover, крышка, кришка	mleczna, frosted, молочная, молочний transparentna, transparent, прозрачная, прозорий	PC	5901867197610
PA-OSTRGLAX3M-00	-	3				5901867197627

Ostonki / Covers / Крышки / Кришки:



PA-OSMLGLAX-00
PA-OSMLGLAX3M-00



PA-OSTRGLAX-00
PA-OSTRGLAX3M-00

PL Profil GLAX przegrodowy dwustronny, do wypełnienia obrzeżem
EN GLAX aluminium edge profile – double sided, option to fill with matching edge banding
RU Профиль LED GLAX разделительный, кромочный, двухсторонний
UK Профіль GLAX перегородковий, двосторонній, для заповнення крайкою

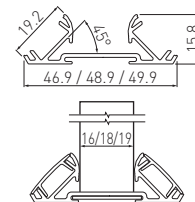

PA-GLAXNBDW3M16-AL	16	3	profil, profile, профиль, профіль	srebrny, silver, серебристый, срібний	aluminium, aluminium, алюминий, алюміній	5902801259050
PA-GLAXNBDW3M-AL	18	3				5902801258664
PA-GLAXNBDW3M19-AL	19	3				5902801257803
PA-OSMLGLAX3M-00	-	3	oslonka, cover, крышка, кришка	mleczna, frosted, молочная, молочний transparentna, transparent, прозрачная, прозорий	PC	5901867197610
PA-OSTRGLAX3M-00	-					5901867197627

Ostonki / Covers / Крышки / Кришки:



PA-OSMLGLAX3M-00



PA-OSTRGLAX3M-00

PL Profil GLAX cokołowy wąski, dwustronny
EN Corner profile GLAX, two-sided, edge mounted
RU Профиль GLAX торцевой, узкий, накладной, двусторонний
UK Профіль GLAX цокольний, вузький, двосторонній

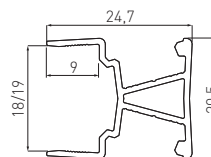

PA-GLAXMNBW3M-AL	18	3	profil, profile, профиль, профіль	srebrny, silver, серебристый, срібний	aluminium, aluminium, алюминий, алюміній	5902801259142
PA-GLAXMNBW3M19-AL	19					5902801281594
PA-OSMLGLAXM3M-00	-		oslonka mini, cover mini, крышка мини, мінікришка	mleczna, frosted, молочная, молочний transparentna, transparent, прозрачная, прозорий	PC	5902801024054
PA-OSTRGLAXM3M-00	-					5902801024047

Oslonki / Covers / Крышки / Кришки:



PA-OSMLGLAXM3M-00



PA-OSTRGLAXM3M-00

PL Profil GLAX cokołowy wąski, jednostronny
EN Corner profile GLAX, one-sided, edge mounted
RU Профиль GLAX торцевой, узкий, накладной, односторонний
UK Профіль GLAX цокольний, вузький, односторонній

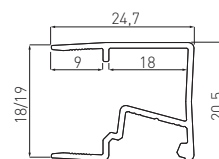

PA-GLAXMNBW3M-AL	18	3	profil, profile, профиль, профіль	srebrny, silver, серебристый, срібний	aluminium, aluminium, алюминий, алюміній	5902801259128
PA-GLAXMNBW3M19-AL	19					5902801281563
PA-OSMLGLAXM3M-00	-		oslonka, cover, крышка, кришка	mleczna, frosted, молочная, молочний transparentna, transparent, прозрачная, прозорий	PC	5902801024054
PA-OSTRGLAXM3M-00	-					5902801024047

Oslonki / Covers / Крышки / Кришки:



PA-OSMLGLAXM3M-00



PA-OSTRGLAMX3M-00

PL Profil GLAX kątowy
EN GLAX corner profile
RU Профиль GLAX угловой
UK Профіль GLAX кутовий

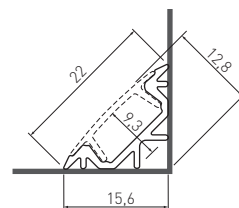

PA-GLAXKT-AL	2	profil, profile, профиль, профіль	srebrny, silver, серебристый, срібний	aluminium, aluminium, алюминий, алюміній	5901867127020
PA-GLAXKT3M-AL	3				5901867196590
PA-OSMLGLAX-00	2	oslonka, cover, крышка, кришка	mleczna, frosted, молочная, молочный	PC	5901867111999
PA-OSMLGLAX3M-00	3		5901867197610		
PA-OSTRGLAX-00	3		transparentna, transparent, прозрачная, прозрачный		5901867112002
PA-OSTRGLAX3M-00	2		5901867197627		
PA-ZASGLAXKT-00	-	zaślepka, end cap, заглушка, кінцевий ковпачок	szary, gray, серый, сірий	ABS	5901867136428

Ostonki / Covers / Крышки / Кришки:

Zaślepka / End cap / Заглушка / кінцевий ковпачок:



PA-OSMLGLAX-00
PA-OSMLGLAX3M-00

PA-OSTRGLAX-00
PA-OSTRGLAX3M-00

PA-ZASGLAXKT-00

PL Profil GLAX kątowy, wpuszczany
EN Recessed corner profile GLAX
RU Профиль GLAX угловой, врезной
UK Профіль LED GLAX кутовий, врізний

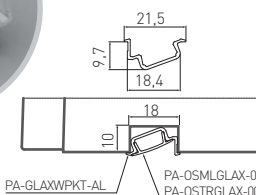

PA-GLAXWPKT-AL PA-OSMLGLAX-00 PA-OSTRGLAX-00

Kąt świecenia 22°
Beam angle 22°
Угол свечения 22°
Кут освітлення 22°



PA-GLAXWPKT-AL	2	profil, profile, профиль, профіль	srebrny, silver, серебристый, срібний	aluminium, aluminium, алюминий, алюміній	5902801257742	
PA-OSMLGLAX-00					mleczna, frosted, молочная, молочный	5901867111999
PA-OSTRGLAX-00					transparentna, transparent, прозрачная, прозрачный	5901867112002

Ostonki / Covers / Крышки / Кришки:



PA-OSMLGLAX-00

PA-OSTRGLAX-00





OPRAWY LED
LED FIXTURES
СВЕТОДИОДНЫЕ СВЕТИЛЬНИКИ
СВІТЛОДИОДНІ СВЕТИЛЬНИКИ

PL Oprawa nakładana / wpuszczana
 EN Fixture surface mounted / recessed
 RU Светильник накладной / врезной
 UK Світлодіодний світильник накладний / врізний

VASCO

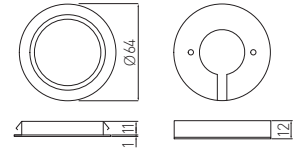

Folder	Light	Color	Material	Barcode
LD-VA24CB-53	130 lm	3000 K	aluminium, aluminium, алюминий, алюміній	5908231382627
LD-VA24NE-53		4000 K		5908231382641
LD-VA24ZB-53		6000 K		5908231382634



PL Oprawa LED
 EN LED fixture
 RU Светильник LED
 UK Світлодіодний світильник

LUMINO

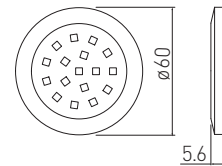

Folder	Light	Color	Material	Barcode
LD-LU16CB-53	70-85 lm	2700 K	biały połysk, white gloss, белый глянец, блискучий білий	5901867164742
LD-LU16NE-53		4000 K		5901867160874
LD-LU16ZB-53		6500 K		5901867160850



PL Oprawa LED
EN LED fixture
RU Светильник LED
UK Світлодіодний світильник

JOVITA

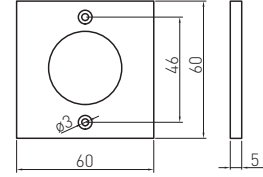

LD-KJVCOB-CB	200 lm	3000 K	aluminium, aluminium, алюминий, алюміній	aluminium, aluminium, алюминий, алюміній	5901867101761
LD-KJVCOB-ZB		6400 K			5901867101778



PL Oprawa LED
EN LED fixture
RU Светильник LED
UK Світлодіодний світильник

JOVITA

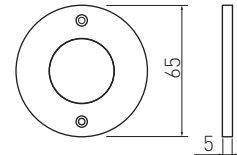

LD-OJVCOB-CB	200 lm	3000 K	aluminium, aluminium, алюминий, алюміній	aluminium, aluminium, алюминий, алюміній	5901867101747



PL Oprawa LED
EN LED fixture
RU Светильник LED
UK Світлодіодний світильник

JOVITA

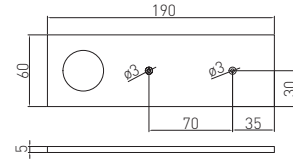

LD-PJVCOB-CB	200 lm	3000 K	aluminium, aluminium, алюминий, алюміній	aluminium, aluminium, алюминий, алюміній	5901867101860



PL Oprawa LED z włącznikiem
EN LED fixture with switch
RU Светильник LED с выключателем
UK Світлодіодний світильник з вимикачем

CASTELLO

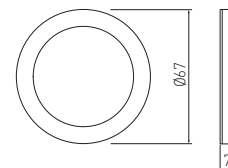

LD-CS36CB-53	180 lm	3000 K	aluminium, aluminium, алюминий, алюміній	tworzywo, plastic, пластик, пластик	5908231382597
LD-CS36NE-53		4000 K			5908231382603
LD-CS36ZB-53		6200 K			5908231382610



PL Oprawa LED
EN LED fixture
RU Светильник LED
UK Світлодіодний світильник

VEGAS

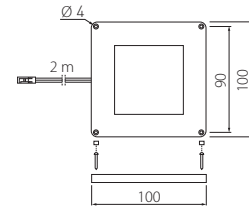

Folder	Light	Color	Material	Material	Barcode
LD-VE15CB-53	140 lm	● 3000 K	aluminium, aluminium, алюминий, алюміній	tworzywo, aluminium plastic, aluminium пластмасса, алюминий пластик, алюминий	5902801032134
LD-VE15NE-53	145 lm	● 4000 K			5902801032189
LD-VE15ZB-53	150 lm	● 6400 K			5902801032127



PL Oprawa 2 w 1
EN Fixture 2 in 1
RU Светильник 2 в 1
UK Світильник 2 в 1

VEGAS

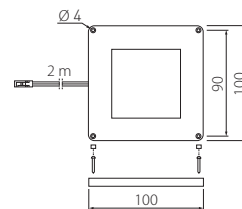

Powiązane produkty:
Włącznik, regulator światła
AE-WLKON-20
Related products:
Switch, colour temperature controller
AE-WLKON-20
Связанные с ними продукты:
выключатель, регулятор цветовой
температуры
AE-WLKON-20
Пов'язані продукти
Вимикач, регулятор світла
AE-WLKON-20



Folder	Light	Color	Material	Material	Barcode
LD-VE15CBZB-53	140 lm	● 3000 K - ● 6400 K	aluminium, aluminium, алюминий, алюміній	tworzywo, aluminium plastic, aluminium пластмасса, алюминий пластик, алюминий	5902801032219



PL Oprawa LED wpuszczana
EN Recessed LED fixture
RU Светодиодный светильник врезной
UK Світлодіодний світильник врізний

ALVARO

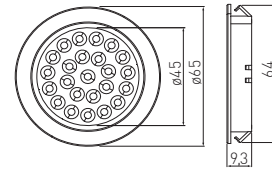

Folder	Light	Color	Material	Barcode	
LD-AL24CB-53	130 lm	3000 K	aluminium, aluminium, алюминий, алюміній	tworzywo, plastic, пластик, пластик	
LD-AL24NE-53		4000 K			5901867156969
LD-AL24ZB-53		6400 K			5901867156952



PL Oprawa LED
EN LED fixture
RU Светильник LED
UK Світлодіодний світильник

TREVI

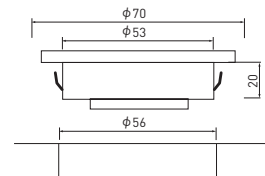

Folder	Light	Color	Material	Barcode	
LD-TR24CB-53	300 lm	3000 K	aluminium, aluminium, алюминий, алюминій	tworzywo, plastic, пластик, пластик	
LD-TR24NE-53	220 lm	4000 K			5902801298950
LD-TR24ZB-53	300 lm	6400 K			5902801032998



PL Oprawa trójkątna z włącznikiem
 EN Triangular LED fixture with a switch-key
 RU Светодиодный светильник треугольный с выключателем
 UK Світлодіодний світильник трикутний з вимикачем

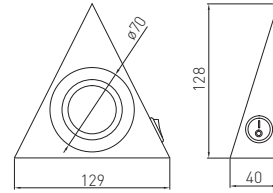

LD-OPT30S-53N	100 lm	● 3000 K	aluminium, aluminium, алюминий, алюміній	stal, steel, сталь, сталь	5901867174512
LD-OPT60S-53N		● 6400 K			5901867174192
LD-OPT60S-51N		● 6400 K	stal szczotkowana, brushed steel, шлифованная сталь, шліфувана сталь		5901867174239



PL Zestaw opraw z włącznikiem
 EN Fixture kit with switch
 RU Комплект светильников с выключателем
 UK Набір світильників з вимикачем

CASTELLO

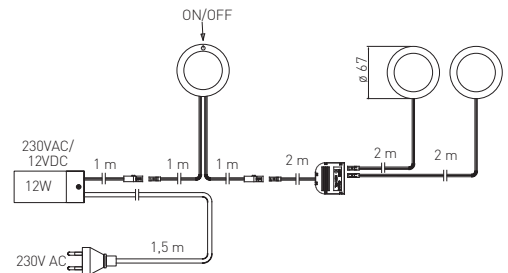

LD-Z3CSCB-53	3x180 lm	● 3000 K	aluminium, aluminium, алюминий, алюміній	tworzywo, plastic, пластик, пластик	5908231389251



PL Zestaw opraw z włącznikiem
 EN Fixture kit with switch
 RU Комплект светильников с выключателем
 UK Набір світильників з вимикачем

CASTELLO

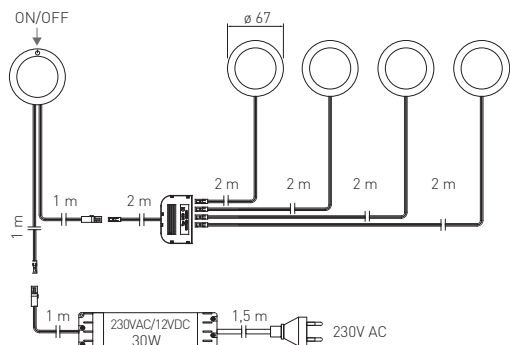

LD-Z5CSCB-53	5x180 lm	3000 K	aluminium, aluminium, алюминий, алюміній	tworzywo, plastic, пластик, пластик	5908231389268



PL Zestaw opraw
 EN Fixture kit
 RU Комплект светильников
 UK Набір світильників

LUGO



- Aluminium
- Chrom
- Satin

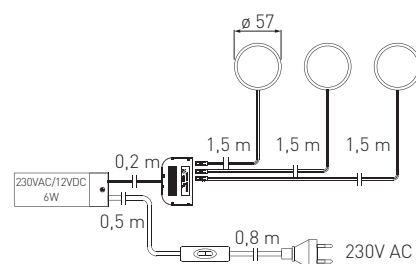

LD-LCG319-53	3x100 lm	3000 K	aluminium, aluminium, алюминий, алюміній	tworzywo, plastic, пластик, пластик	5908231301024
LD-LUG319-53		6400 K			5908231301017
LD-LCG319-40		3000 K	chrom, chrome, хром, хром		5908231301031
LD-LUG319-40		6400 K			5908231300997
LD-LCG319-52		3000 K	satyna, satin, сатин, сатин		5908231301048
LD-LUG319-52		6400 K			5908231301000



PL Zestaw opraw
EN Fixture kit
RU Комплект светильников
UK Набір світильників

BARRI

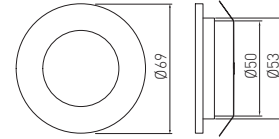

LD-OBP27CB-53	3x80 lm	● 2700 K	aluminium, aluminium, алюминий, алюміній	tworzywo, aluminium plastic, aluminium пластмасса, алюминий пластик, алюминій	5908231374127
LD-OBP27ZB-53		● 6400 K			5908231374134



PL Zestaw opraw
EN Fixture kit
RU Комплект светильников
UK Набір світильників

MARBELLA

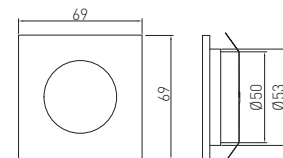

LD-KWP27CB-53	3x80 lm	● 2700 K	aluminium, aluminium, алюминий, алюміній	tworzywo, aluminium plastic, aluminium пластмасса, алюминий пластик, алюминій	5908231374103
LD-KWP27ZB-53		● 6400 K			5908231374110



PL Oprawa LED wpuszczana
 EN Recessed LED fixture
 RU Светодиодный светильник врезной
 UK Світлодіодний світильник врізний

OVIEDO

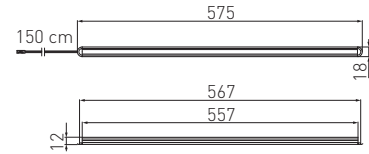

LD-WL2457-53	90 lm	6400 K	aluminium, aluminium, алюминий, алюміній	tworzywo, aluminium plastic, aluminium пластмасса, алюминий пластик, алюминій	5908231301864



PL Oprawa podszafkowa z włącznikiem
 EN Cabinet fixture with switch
 RU Светильник под шкафчики с выключателем
 UK Світлодіодний світильник під шафу з вимикачем

FRAGA

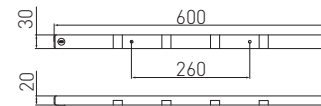
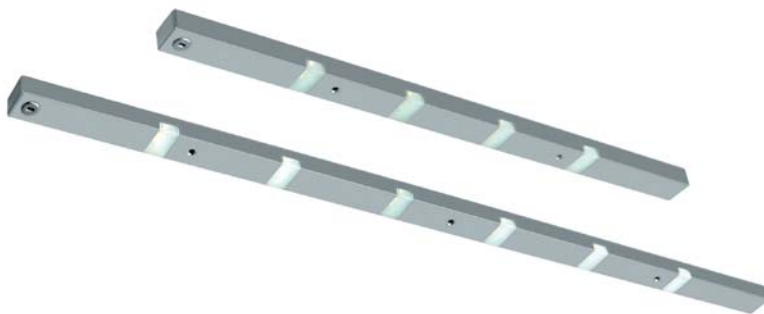

LD-OP408C-53	3 W	90 lm	6400 K	aluminium, aluminium, алюминий, алюміній	tworzywo, aluminium plastic, aluminium пластмасса, алюминий пластик, алюминій	5908231301833



PL Oprawa podszafkowa
 EN Cabinet fixture
 RU Светильник под шкафчики
 UK Світлодіодний світильник під шафу

ROTA

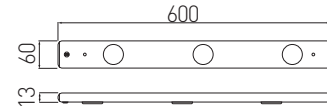

Folder	Wattage	Lumen	Color	Material	Material	Barcode
LD-OP456C-53	4,2 W	230 lm	● 6400 K	aluminium, aluminium, алюминий, алюміній	tworzywo, aluminium plastic, aluminium пластмасса, алюминий пластик, алюминий	5908231301802
LD-OP609C-53	5,5 W	310 lm				5908231301819



PL Oprawa podszafkowa
 EN Cabinet fixture
 RU Светильник под шкафчики
 UK Світлодіодний світильник під шафу

OPD



Folder	Wattage	Lumen	Color	LxWxH mm	Material	Material	Barcode
LD-OPD5W0-CB	5 W	300 lm	● 3000 K	325 x 30 x 22	chrom, chrome, хром, хром	metal, metal, металл, металл	5901867158376
LD-OPD9W0-CB	9 W	350 lm		585 x 30 x 22			5901867158383



PL Oprawa z czujnikiem zbliżeniowym
EN Fixture with proximity sensor
RU Светильник с датчиком приближения
UK Світлодіодний світильник з датчиком наближення

SORIA

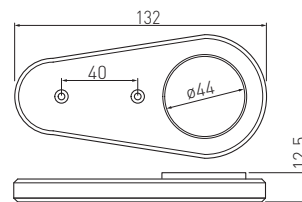

Folder	Light	Color	Material	Material	Barcode
LD-SR16CB-53	90-110 lm	3000 K	aluminium, aluminium, алюминий, алюміній	aluminium, aluminium, алюминий, алюміній	5908231387110
LD-SR16NE-53		4000 K			5908231387127
LD-SR16ZB-53		6400 K			5908231387134



PL Oprawa na wysięgniku
EN Fixture with arm
RU „Светильник типа „дуга”
UK Світлодіодний світильник на консолі

RADIUS II

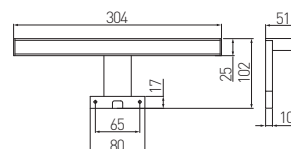

Folder	Light	Color	Material	Material	Barcode
LD-RA60CB-40N	220 lm	3000 K	chrom, chrome, хром, хром	tworzywo, plastic, пластик, пластик	5902801231070
LD-RA60ZB-40N		6000 K			5902801234699

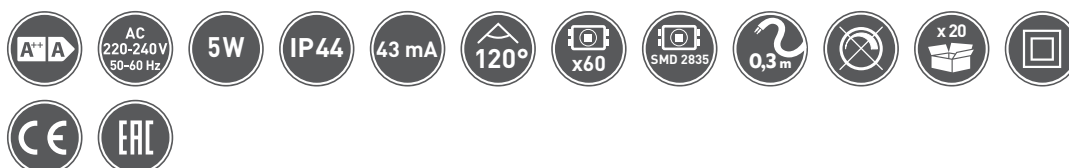

PL Oprawa na wycięgniку
EN Fixture with arm
RU Светильник типа „дуга”
UK Світлодіодний світильник на консолі

MAXIMUS

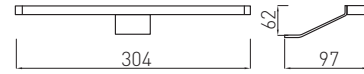

LD-MAX60CB-40N	160 lm	3000 K	chrom, chrome, хром, хром	tworzywo, aluminium plastic, aluminium пластмасса, алюминий пластик, алюминий	5902801033575
LD-MAX60ZB-40N		6400 K			5902801033537



PL Oprawa na wycięgniку
EN Fixture with arm
RU Светильник типа „дуга”
UK Світлодіодний світильник на консолі

ABELLA

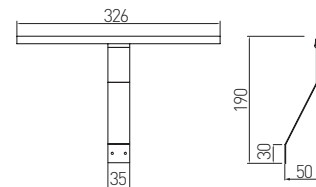

LD-AB18CB-53	460 lm	3000 K	aluminium, aluminium, алюминий, алюминий	stal, tworzywo, aluminium steel, plastic, aluminium сталь, пластмасса, алюминий сталь, пластик, алюминий	5908231396310
LD-AB18ZB-53		6400 K			5908231396303



PL Oprawa na wysięgniku
EN Fixture with arm
RU Светильник типа „дуга”
UK Світлодіодний світильник на консолі

EVITA

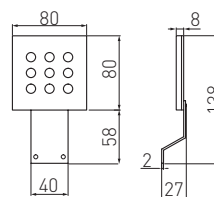

LD-EIW09CB-CZ	120 lm	3000 K	czarny, black, черный, чорний	tworzywo, aluminium plastic, aluminium пластмасса, алюминий пластик, алюминій	5901867101402



PL Oprawa na wysięgniku
EN Fixture with arm
RU Светильник типа „дуга”
UK Світлодіодний світильник на консолі

NOELIA

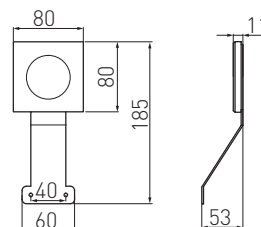

LD-NO24CB-00	330 lm	3000 K	aluminium, aluminium, алюминий, алюміній	tworzywo, aluminium plastic, aluminium пластмасса, алюминий пластик, алюминій	5908231398260
LD-NO24ZB-00		6400 K			5908231398277



PL Oprawa na wycięgniку
EN Fixture with arm
RU Светильник типа „дуга”
UK Світлодіодний світильник на консолі

FIDELIA

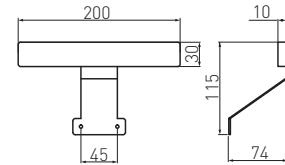

LD-FL36CB-00	155 lm	● 3000 K	aluminium, aluminium, алюминий, алюміній	tworzywo, aluminium plastic, aluminium пластмасса, алюминий пластик, алюміній	5902801003264
LD-FL36ZB-00	165 lm	● 6400 K			5908231398291



PL Oprawa na wycięgniку
EN Fixture with arm
RU Светильник типа „дуга”
UK Світлодіодний світильник на консолі

CALDERON

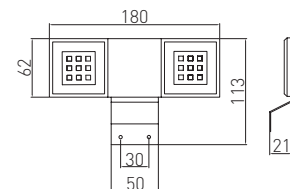

LD-NKW18CB-40	270 lm	● 3000 K	chrom, chrome, хром, хром	stal, tworzywo steel, plastic сталь, пластмасса сталь, пластик	5908231386557
LD-NKW18ZB-40		● 6400 K			5908231364838



PL Oprawa LED bezprzewodowa
EN Cordless LED fixture
RU Светодиодный светильник беспроводной
UK Світильник бездротовий

COMA



LD-IRUSB-53

LD-PIRUSB-53

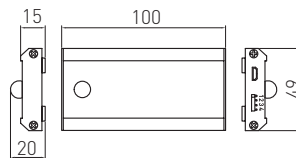

Przewód USB (do ładowania) - 0,5 m w komplecie
Additional 0,5m USB cable (for charging)
Дополнительный кабель USB (для зарядки) - 0,5 м
Провід USB (для зарядки) - 0,5 м в комплекті

				INFO			
LD-IRUSB-53				Czujnik zbliżeniowy IR, jedno- lub dwu-biegowy, Proximity sensor IR, single or double-pole, Датчик движения IR, одно- и многофункциональный, Сенсор IR, одно або двофункційний	aluminium, aluminium, алюминий, алюміній	stal, tworzywo steel, plastic сталь, пластмасса сталь, пластик	5901867188182
LD-PIRUSB-53				Czujnik ruchu PIR, jednobiegowy, Proximity sensor IR, single-pole, Датчик движения PIR, однофункциональный, Сенсор руху PIR, однофункційний			5901867188199
		40-50 lm	● 4000 K				



PL Lampka z portem USB
EN Bed lamp with USB
RU Гибкая лампа с USB-разъемом
UK Лампа з USB-портом

CHICAGO



White

Black

Wymaga zasilacza 12 V, 30 W
Requires 12 V, 30 W power supply
Требуется блок питания 12 В, 30 Вт
Вимагає блоку живлення 12 В, 6 W

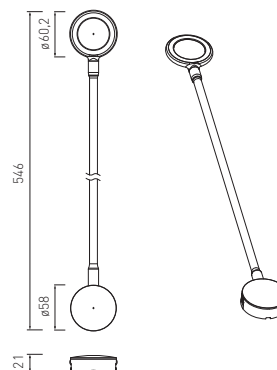

LD-CHIC16NE-10				metal, tworzywo metal, plastic металл, пластмасса метал, пластик	biały, white, белый, білий	5901867177919
LD-CHIC16NE-20					czarny, black, черный, чорний	5901867177933
		120 lm	● 4000 K			



PL Lampka
EN Lamp
RU Лампа
UK Лампа

BOSTON

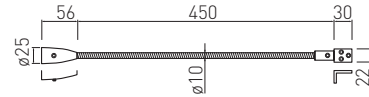

Wymaga zasilacza 12 V, 6 W
Requires 12 V, 6 W power supply
Требуется блок питания 12 В, 6 Вт
Вимагає блоку живлення 12 В, 6 Вт

LD-BOS1CBWG-53	90 lm	● 3000 K	aluminium, aluminium, алюминий, алюміній	stal, tworzywo, aluminium steel, plastic, aluminium сталь, пластмасса, алюминий сталь, пластик, алюминій	5902801002915
LD-BOS1CBWB-53					5902801002939



PL Klip plastikowy LED do półek
EN Plastic LED clip for shelves
RU Пластиковая клипса LED для стеклянных полок
UK Кліпс світлодіодний пластмасовий для полиці

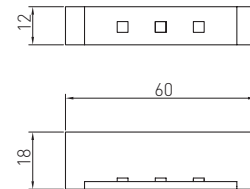

LD-KLPCB-00N	10 lm	● 3000 K	tworzywo, plastic, пластик, пластик	5901867188205
LD-KLPNB-00N	-	niebieski, blue, синий, синій		5901867173997
LD-KLPZB-00N	12 lm	● 6400 K		5901867187734



PL Klip metalowy LED do półek
 EN Metal LED clip for shelves
 RU Металлическая клипса LED для стеклянных полок
 UK Кліпс світлодіодний металевий для полиці

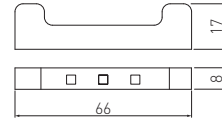

LD-3SKL-CBN	10 lm	● 3000 K	stal, steel, сталь, сталь	5901867183538
LD-3SKL-NBN	-	niebieski, blue, синий, синій		5901867183514
LD-3SKL-ZBN	12 lm	● 6400 K		5901867175212



PL Mini lampka wtykowa LED
 EN Mini plug-in LED lamp
 RU Светодиодный мини-светильник в розетку
 UK Світлодіодна штепсельна лампа міні

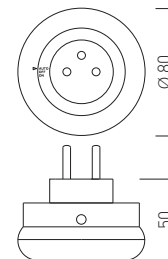

LD-ML1000-00	1W	● 4000 K	50 lm	tworzywo, plastic, пластмасса, пластик	78 g	5902801023392



PL Mini lampka wtykowa LED
 EN Mini plug-in LED lamp
 RU Светодиодный мини-светильник в розетку
 UK Світлодіодна штепсельна лампа міні

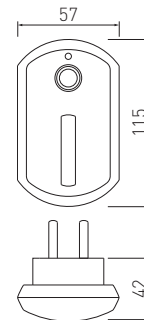

LD-ML2000-00	1W	● 4000 K	50 lm	tworzywo, plastic, пластмасса, пластик	72 g	5902801023392
--------------	----	----------	-------	--	------	---------------



PL Mini lampka wtykowa LED
 EN Mini plug-in LED lamp
 RU Светодиодный мини-светильник в розетку
 UK Світлодіодна штепсельна лампа міні

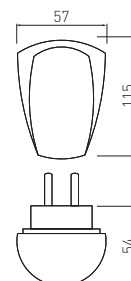

LD-ML3000-00	1W	● 4000 K	50 lm	tworzywo, plastic, пластмасса, пластик	37 g	5902801023453
--------------	----	----------	-------	--	------	---------------



PL Mini lampka wtykowa LED
 EN Mini plug-in LED lamp
 RU Светодиодный мини-светильник в розетку
 UK Світлодіодна штепсельна лампа міні

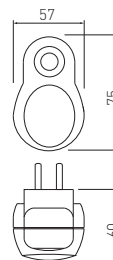

LD-ML4000-00	1W	● 4000 K	50 lm	tworzywo, plastic, пластмасса, пластик	52 g	5902801023484



PL Mini lampka wtykowa LED
 EN Mini plug-in LED lamp
 RU Светодиодный мини-светильник в розетку
 UK Світлодіодна штепсельна лампа міні

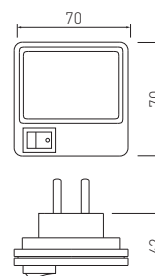

LD-ML5000-00	1W	● 4000 K	50 lm	tworzywo, plastic, пластмасса, пластик	46 g	5902801023514







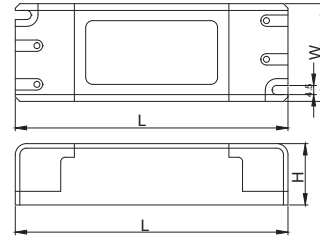

AKCESORIA
ACCESSORIES
AKCECCYAPY
AKCECYAPИ

PL Zasilacz LED PRO
EN LED PRO power supplies
RU Блоки питания LED PRO
UK Блок живлення LED PRO



		 LxWxH mm			
LD-ZASPRO07W-30	7 W	100 x 39 x 25 mm	tworzywo, plastic, пластик, пластик	56 g	5902801208331
LD-ZASPRO12W-30	12 W	120 x 42 x 27 mm		82 g	5902801207952
LD-ZASPRO16W-30	16 W	120 x 42 x 27 mm		82 g	5902801207983
LD-ZASPRO24W-30	24 W	140 x 47 x 29 mm		109 g	5902801208270
LD-ZASPRO33W-30	33 W	140 x 47 x 29 mm		150 g	5902801251702
LD-ZASPRO54W-30	54 W	155 x 53 x 30 mm		173 g	5902801207976
LD-ZASPRO65W-30	65 W	181 x 63 x 40 mm		281 g	5902801207969
LD-ZASPRO80W-30	80 W	181 x 63 x 40 mm		290 g	5902801208010



PL Zasilacz LED
EN LED power supplies
RU Блоки питания LED
UK Блок живлення LED

OUTPUT
12 V DC

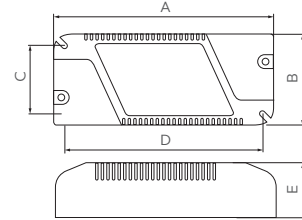

LD-ZAS75W-30	max 75 W	AxBxCxDxE mm 180 x 52 x 42 x 176 x 30	tworzywo, plastic, пластик, пластик	350 g	5901867141477



PL Zasilacz LED
EN LED power supplies
RU Блоки питания LED
UK Блок живлення LED

OUTPUT
24 V DC

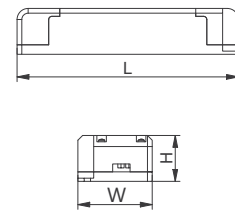

LD-ZAS24PRO80W-30	80 W	LxWxH mm 181 x 63 x 40 mm	tworzywo, plastic, пластик, пластик	300 g	5902801237409



PL Układ zasilający
EN LED power supplies
RU Блок питания
UK Система електроживлення

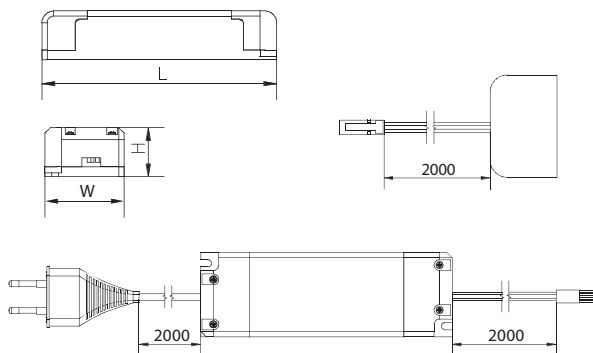

LD-ZZAS07PROKD6	7 W	100 x 39 x 25	tworzywo, plastic, пластик, пластик	5902801246180
LD-ZZAS12PROKD6	12 W	120 x 42 x 27		5902801246364
LD-ZZAS16PROKD6	16 W	120 x 42 x 27		5902801245848
LD-ZZAS24PROKD6	24 W	140 x 47 x 29		5902801246203
LD-ZZAS33PROKD6	33 W	155 x 53 x 30		5902801231087



PL Zasilacz LED SLIM HQ
EN LED power supply SLIM HQ
RU Блок питания LED SLIM HQ
UK Блок живлення LED SLIM HQ

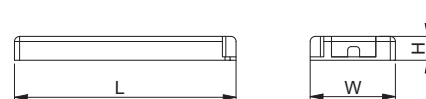

LD-SZAHQ06W-MA**	6 W	98 x 46 x 11 mm	tworzywo, plastic, пластик, пластик	42 g	5902801228599
LD-SZAHQ15W-MA*	15 W	128 x 50 x 14 mm		74 g	5902801207808
LD-SZAHQ30W-MA*	30 W	156 x 50 x 17 mm		128 g	5902801208003
LD-SZAHQ50W-MA	50 W	160 x 58 x 18 mm		151 g	5902801207624
LD-SZAHQ75W-MA	75 W	160 x 58 x 18 mm		160 g	5902801206962



PL Zasilacz LED
EN LED power supplies
RU Блоки питания LED
UK Блок живлення LED

OUTPUT
12 V DC

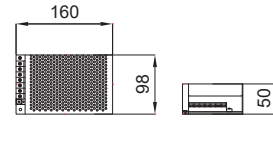

LD-ZAS150-NW	max 150 W	160 x 98 x 50	aluminium, aluminium, алюминий, алюміній	347 g	5901867128829



PL Zasilacz LED
EN LED power supplies
RU Блоки питания LED
UK Блок живлення LED

OUTPUT
12 V DC

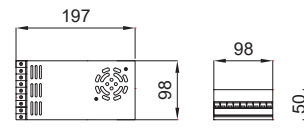

LD-ZAS350-NW	max 350 W	197 x 98 x 50	aluminium, aluminium, алюминий, алюміній	589 g	5901867128843



PL Zasilacze LED
EN LED power supply units
RU Блоки питания LED
UK Блоки живлення LED

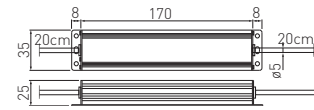

LD-WZA20W-NW

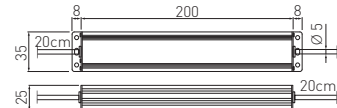

LD-WZA36W-NW

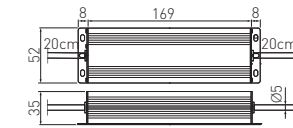

LD-WZA60W-NW



LD-WZA80W-NW

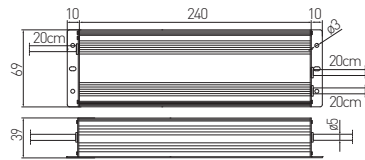

LD-WZA150W-NW

Folder	Wattage	Weight	Barcode
LD-WZA20W-NW	20 W	170 g	5901867128720
LD-WZA36W-NW	36 W	310 g	5901867128744
LD-WZA60W-NW	60 W	990 g	5901867128768
LD-WZA80W-NW	80 W	1000 g	5901867128782
LD-WZA150W-NW	150 W	2000 g	5901867128805



PL Zasilacz LED puszkowy
EN LED power supply
RU Блок живлення LED
UK Блок живлення коробковий

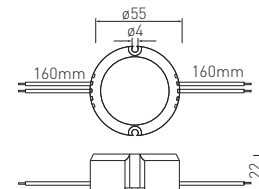

Folder	Wattage	Material	Barcode
LD-ZASPU15W-30N	15 W	tworzywo, plastic, пластик, пластик	5902801020094



PL Układ zasilający do klipów LED 5-punktowy
 EN Power feeder set for 5 LED clips
 RU Блок питания для светодиодных клипс, 5 разъёмов
 UK Система електроживлення для 5-точкових світлодіодних затискачів

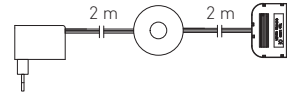

LD-ZSKL15-00N

tworzywo, plastic, пластик, пластик

5902801270970



PL Układ zasilający
 EN Power feeder set
 RU Блок питания
 UK Система електроживлення

OUTPUT
12 V DC

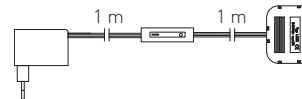

LD-ZWND6W-10

max6 W

5908231335753

LD-ZWND12-10

max 12 W

5908231336675

tworzywo, plastic, пластик, пластик



PL Transformator elektroniczny do żarówek halogenowych
 EN Electronic power supply for halogen lamp
 RU Электронный трансформатор для галогенной лампы
 UK Трансформатор електронний для галогенних лампочок

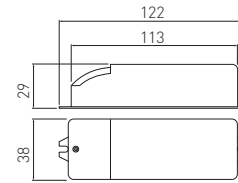

TE-600000-30	max 60 W	tworzywo, plastic, пластмасса, Блок пластик	5908231300928



PL Kontroler RGB mini z pilotem
 EN Mini RGB controller with remote control
 RU Миниконтроллер RGB с пультом
 UK Світлодіодний контролер RGB з міні-пультом

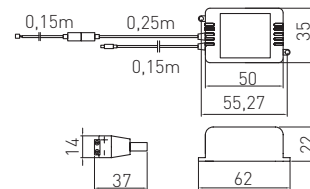

LD-KONMINI-RGB	RGB	tworzywo, plastic, пластмасса, Блок пластик	5908231384676



- PL Zestaw RGB - kontroler, zasilacz LED 6W, pilot i dystrybutor
 EN RGB kit - RGB controller, power supply, remote control and distributor
 RU Комплект RGB – контролер, трансформатор 6W, пульт, дистрибьютор
 UK Набір RGB, контролер, світлодіодний блок живлення 6Вт, пульт і розподільник



LD-ZAC6WDE-RGB

RGB

tworzywo, plastic, пластик, пластик

5908231399663



- PL Zestaw RGB, taśma LED 5 m, kontroler, zasilacz, pilot
 EN RGB-set, LED band 5 m, RGB controller, LED-transformator, remote control
 RU Комплект RGB, лента LED 5 м, контролер, трансформатор, пульт
 UK Набір RGB, світлодіодна стрічка 5 м, контролер, блок живлення, пульт



LD-ZL5RGB150-00

RGB

tworzywo, plastic, пластик, пластик

5902801025839



PL Kontroler 1-strefowy MONO
EN 1-zone controller MONO
RU 1-х зонный контроллер MONO
UK Контролер 1-зонний MONO

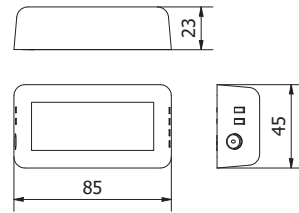

LD-KONML-MONO

RGB

tworzywo, plastic, пластик, пластик

5902801200151



PL Kontroler 1-strefowy RGBW
EN 1-zone controller RGBW
RU 1-х зонный контроллер RGBW
UK Контролер 1-зонний RGBW

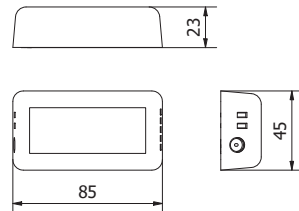

LD-KONML-RGBW

RGB

tworzywo, plastic, пластик, пластик

5902801200519



PL Kontroler WiFi
EN WiFi-Controller
RU WiFi - контроллер
UK WiFi - контролер

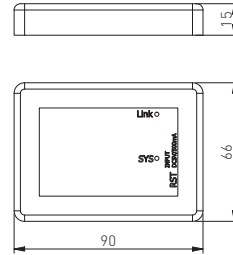

LD-KONML-WIFI

RGB

tworzywo, plastic, пластик, пластик

5902801200588



PL Pilot 4-strefowy MONO
EN 4-zone remote controller MONO
RU 4-зонный пульт дистанционного управления MONO
UK 4-зонний пульт дистанційного керування MONO

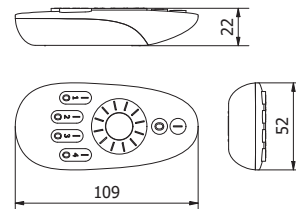

LD-KONML-MONO-PIL

tworzywo, plastic, пластик, пластик

5902801200502



PL Pilot 4-strefowy RGBW
 EN 4-zone remote controller RGBW
 RU 4-зонный пульт дистанционного управления RGBW
 UK 4-зонний пульт дистанційного керування RGBW

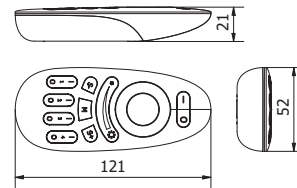

LD-KONML-RGBW-PIL	RGB	tworzywo, plastic, пластик, пластик	5902801200380
-------------------	-----	-------------------------------------	---------------



PL Panel dotykowy 4-strefowy na baterie MONO
 EN Battery powered 4-zone touch panel MONO
 RU 4-зонная сенсорная панель с батарейками MONO
 UK 4-зонна сенсорна панель з батарейками MONO

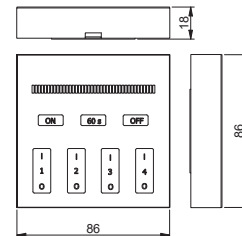

LD-KONML-MONO-PAN	tworzywo, plastic, пластик, пластик	5902801200571
-------------------	-------------------------------------	---------------



- PL Panel dotykowy 4-strefowy na baterie RGBW
 EN Battery powered 4-zone touch panel RGBW
 RU 4-зонная сенсорная панель с батарейками RGBW
 UK 4-зонна сенсорна панель з батарейками RGBW

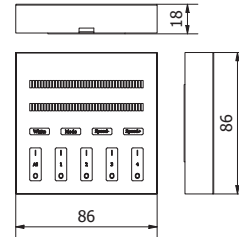

LD-KONML-WRGB-PAN	RGB	tworzywo, plastic, пластик, пластик	5902801200489
-------------------	-----	-------------------------------------	---------------



- PL Adapter do pilota
 EN Remote control adapter
 RU Адаптер пульта дистанционного управления
 UK Адаптер пульта дистанційного керування

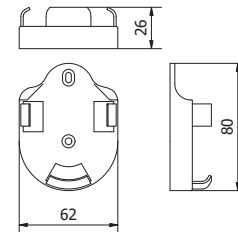

LD-KONML-AD	biały, white, белый, білий	tworzywo, plastic, пластик, пластик	5902801200700
-------------	----------------------------	-------------------------------------	---------------



PL Włącznik dotykowy bezprzewodowy on-off
 EN Wireless touchless switch on-off
 RU Беспроводной сенсорный выключатель on-off
 UK Бездротовий сенсорний вимикач on-off



White

Black

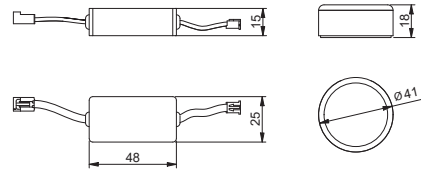

AE-WDBP1-10	biały, white, белый, білий	tworzywo, plastic, пластик, пластик	5902801223204
AE-WDBP1-20	czarny, black, черный, чорний		5902801223044



PL Włącznik dotykowy bezprzewodowy CCT
 EN Wireless touchless switch CCT
 RU Беспроводной сенсорный выключатель CCT
 UK Бездротовий сенсорний вимикач CCT



White

Black

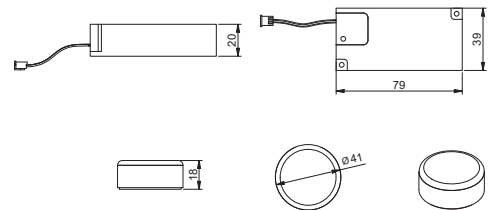

AE-WDBP2CCT-10	biały, white, белый, білий	tworzywo, plastic, пластик, пластик	5902801212772
AE-WDBP2CCT-20	czarny, black, черный, чорний		5902801213021



PL Włącznik bezdotykowy
EN Touchless switch
RU Бесконтактный датчик
UK Безконтактний вимикач

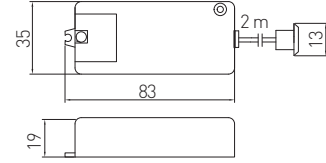

INFO



AE-WBEZDC-10S	dwubiegowy two-pole двухфункциональный двошвидкісний	tworzywo, plastic, пластик, пластик	5901867160348
AE-WBEZDB-10S*	jednobiegowy single-pole однофункциональный одношвидкісний		5901867160324



PL Włącznik dotykowy pod śrubę
EN Touch switch for a screw
RU Сенсорный выключатель под винт
UK Сенсорний вимикач під гвинт

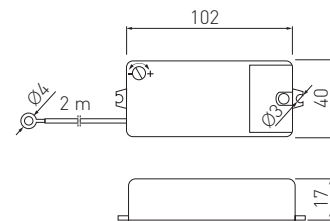

AE-WBEZDK15-10	tworzywo, plastic, пластик, пластик	5902801032110
----------------	-------------------------------------	---------------



PL Włącznik z czujnikiem ruchu PIR
 EN Switch with PIR motion detector
 RU Выключатель с датчиком движения PIR
 UK Вимикач з датчиком руху PIR

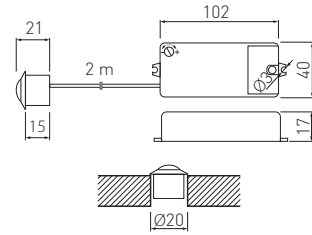

AE-WBEZDPIR-10

tworzywo, plastic, пластик, пластик

5902801032141



PL Włącznik z dwoma sensorami ruchu PIR II
 EN Switch with two PIR II motion sensors
 RU Выключатель с двумя датчиками движения PIR II
 UK Вимикач з двома датчиками руху PIR II

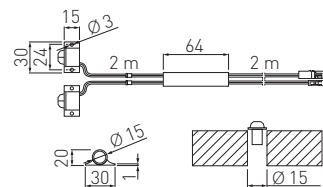

AE-WBEZDPIR2-20

tworzywo, plastic, пластик, пластик

5902801032639



PL Włącznik bezdotykowy uniwersalny 3 w 1
 EN 3 in 1 all-purpose touchless switch
 RU Бесконтактный выключатель 3 в 1
 UK Безконтактний вимикач універсальний 3 в 1



White

Black

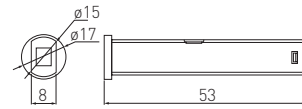

AE-WBBUNI-10DIM	biały, white, белый, білий	tworzywo, plastic, пластик, пластик	5901867158338
AE-WBCUNI-10DIM	czarny, black, черный, чорний		5901867158352



PL Włącznik dotykowy ściemniający
 EN Dimmable touch switch
 RU Выключатель с регулятором яркости
 UK Сенсорний вимикач з диммером



White

Black

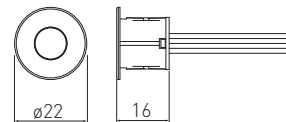

AE-WDSB-10DIM	biały, white, белый, білий	tworzywo, plastic, пластик, пластик	5901867175724
AE-WDSC-10DIM	czarny, black, черный, чорний		5901867175748



PL Włącznik dotykowy ściemniający
EN Dimmable touch switch
RU Выключатель с регулятором яркости
UK Сенсорний вимикач з диммером

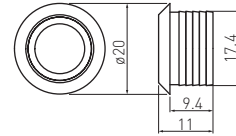

AE-WBEZD-NB

chrom, chrome, хром, хром

tworzywo, plastic, пластик, пластик

5901867143686



PL Włącznik podblatowy
EN Countertop switch
RU Выключатель под столешницу
UK Вимикач під стільницю

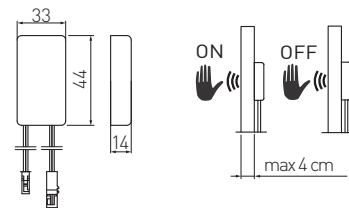

Grubość blatu max 40 mm
Countertop thickness max 40 mm
Толщина столешницы макс. 40 мм
Товщина поверхні максимум 40 мм



AE-WPDRW-00

tworzywo, plastic, пластик, пластик

5901867127167



PL Włącznik do taśm LED montowany w profil
 EN Switch for LED strips mounted in profile
 RU Выключатель для ленты LED
 UK Вимикач для світлодіодний стрічок, що встановлюється в профілі

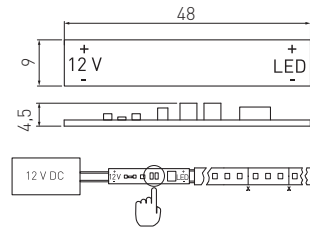

AE-WLPR-60	-	biały, white, белый, білий	plytka elektroniczna circuit board электронная плата електронна панель	5908231398284
AE-WLPR-60P2	2 m			5902801022005



PL Włącznik kotywkowy
 EN Button switch
 RU Выключатель кнопочный
 UK Вимикач кнопочний

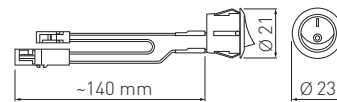

AE-WLB01-10	biały, white, белый, білий	tworzywo, plastic, пластик, пластик	5902801004346
AE-WLC01-20	czarny, black, черный, чорний		5902801004322



PL Przełącznik kołyskowy okrągły
EN Round rocker switch
RU Выключатель клавишный круглый
UK Вимикач кнопковий круглий



AE-WLIP44-15	tworzywo, plastic, пластмасса, пластик	biały, white, белый, білий.	5901867125071
--------------	--	-----------------------------	---------------



PL Włącznik, regulator światła
EN Switch, colour temperature controller
RU Выключатель, регулятор цветовой температуры
UK Вимикач, регулятор світла

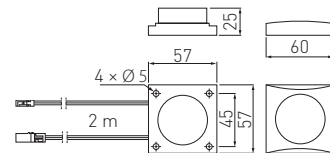

AE-WLKON-20	czarny, black, черный, чорний	tworzywo, plastic, пластик, пластик	5902801032707
-------------	-------------------------------	-------------------------------------	---------------



PL Ściemniacz LED
EN LED dimmer
RU Светодиодный диммер
UK Світлодіодний диммер

JACKY

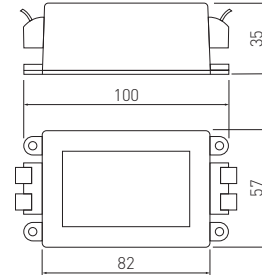

LD-DIMLED-10	czarny, black, черный, чорний	PC	800 g	5908231337597



PL Włącznik łańcuszkowy
EN Pull chain switch
RU Цепной выключатель
UK Ланцюговий вимикач



AE-WLLAN1-10	chrom, chrome, хром, хром	tworzywo, plastic, пластик, пластик	2000	5908231313942



PL Włącznik sznurkowy
EN Pull cable switch
RU Шнурочный выключатель
UK Дротовий вимикач



AE-WLSZN1-10	polipropylen, polypropylene, полипропилен, полипропилен.	czarny, black, черный, schwarz, fekete	590823133186
--------------	--	--	--------------



PL Kabel zasilający z wtyczką i włącznikiem
EN Cable with plug and switch
RU Кабель с вилкой и выключателем
UK Кабель живлення з вилкою і вимикачем

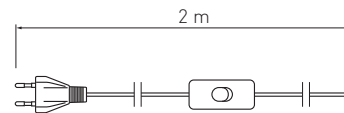

LD-KABE2M-00	biały, white, белый, білий	tworzywo, plastic, пластик, пластик	5908231335265
--------------	----------------------------	-------------------------------------	---------------



PL Przewód ze złączkami mini AMP
 EN Cable with Mini AMP
 RU Кабель с соединителями мини-АМП
 UK Провід з конекторами міні АМП

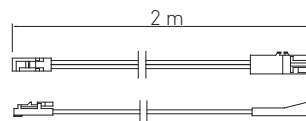

LZ-KAPR2M-10	czarny, black, черный, чорний	tworzywo, plastic, пластик, пластик	5908231335876



PL Złączka do oświetlenia ledowego z dystrybutorem, 3 gniazda
 EN LED fixtures connector with distributor, 3 sockets
 RU Соединитель LED с распределителем, 3 гнезда
 UK Роз'єм для світлодіодного освітлення з розподільником, 3 гнізда

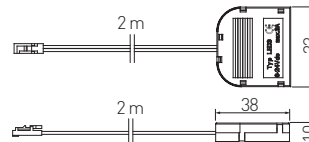

LZ-AKZ312-10N	czarny, black, черный, чорний	tworzywo, plastic, пластик, пластик	5901867174017



PL Złączka do oświetlenia ledowego z dystrybutorem, 6 gniazd
 EN LED fixtures connector with distributor, 6 sockets
 RU Соединитель LED с распределителем, 6 гнезд
 UK Роз'єм для світлодіодного освітлення з розподільником, 6 гнізд

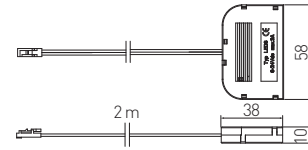

LZ-AKZ612-10N	czarny, black, черный, чорний	tworzywo, plastic, пластик, пластик	5901867187598



PL Złączka XC11 do taśm LED
 EN Connector XC11 for LED strips
 RU Соединитель XC11 для лент LED
 UK Роз'єм XC11 для світлодіодних стрічок



LD-ZTL8MM-02N



LD-ZTL8MM-02N600

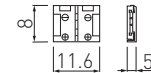

LD-ZTL8MM-02N, LD-ZTL8MM-02N600



LD-ZTL10MM-02N



LD-ZTLRGB-04N

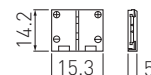

LD-ZTL10MM-02N, LD-ZTLRGB-04N

	INFO		
LD-ZTL8MM-02N	8 mm	tworzywo, plastic, пластик, пластик	5901867172556
LD-ZTL8MM-02N600	8 mm / 600 LED		5902801001536
LD-ZTL10MM-02N	10 mm		5901867172587
LD-ZTLRGB-04N	RGB		5901867172617



PL Złączka XC11 do taśm LED kątowa
 EN Angular connector XC11 for LED strips
 RU Угловой соединитель XC11 для лент LED
 UK Роз'єм XC11 для світлодіодних стрічок кутовий



LD-ZTKT8MM-02N



LD-ZTKT8MM-02N600

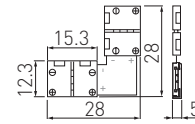

LD-ZTKT8MM-02N, LD-ZTKT8MM-02N600



LD-ZTKT10MM-02N



LD-ZTKTRGB-02N

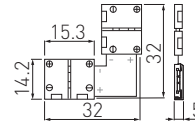

LD-ZTKT10MM-02N

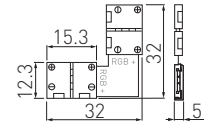

LD-ZTKTRGB-04N



INFO



LD-ZTKT8MM-02N	8 mm	tworzywo, plastic, пластик, пластик	5901867172853
LD-ZTKT8MM-02N600	8 mm / 600 LED		5902801001550
LD-ZTKT10MM-02N	10 mm		5901867172884
LD-ZTKTRGB-04N	RGB		5901867172822



PL Złączka XC11 do taśm LED z przewodem 15 cm
 EN Connector XC11 with 15 cm cord, for strips
 RU Соединитель XC11 для лент LED, с проводом 15 см
 UK Роз'єм XC11 для світлодіодних стрічок з кабелем 15 см



LD-ZTK8MM-02N

LD-ZTK8MM-02N600

LD-ZTK10MM-02N

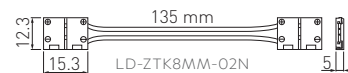

LD-ZTK8MM-02N

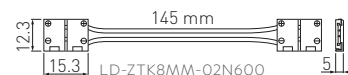

LD-ZTK8MM-02N600

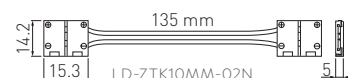

LD-ZTK10MM-02N



INFO



LD-ZTK8MM-02N	8 mm	tworzywo, plastic, пластик, пластик	5901867172730
LD-ZTK8MM-02N600	8 mm / 600 LED		5902801001543
LD-ZTK10MM-02N	10 mm		5901867172761



PL Złączka XC11 do taśm LED z przewodem 2 m
 EN Соединитель XC11 для светодиодных лент, с проводом 2 м
 RU Соединитель XC11 для лент LED, с проводом 2 м
 UK Роз'єм XC11 для світлодіодних стрічок з кабелем 2 м



LD-ZTL82M-2N LD-ZTL82M-2N600 LD-ZTL102M-2N LD-ZTLRGB2M-4N



LD-ZTL82M-2N, LD-ZTL82M-2N600



LD-ZTL102M-2N

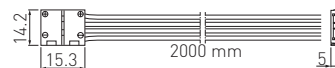

LD-ZTLRGB2M-4N



INFO



LD-ZTL82M-2N	8 mm	tworzywo, plastic, пластик, пластик	5901867172648
LD-ZTL82M-2N600	8 mm / 600 LED		5902801001567
LD-ZTL102M-2N	10 mm		5901867172679
LD-ZTLRGB2M-4N	RGB		5901867172709



PL Złączka XC11 do taśm LED z przewodem 2 m i mini amp
 EN Connector XC11 with 2 m cord and mini AMP, for LED strips
 RU Соединитель XC11 для лент LED, с проводом 2 м и мини amp
 UK Роз'єм XC11 для світлодіодних стрічок з кабелем 2м і mini amp

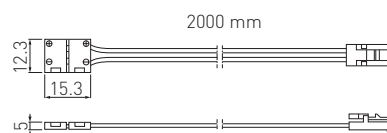

INFO



LD-ZTL8MMAMP-02N	8 mm	tworzywo, plastic, пластик, пластик	5901867172792
LD-ZTL8MMAMP-02N600	8 mm / 600 LED		5902801001574



PL Złączka XC11 do taśm LED SLIM
 EN Connector XC11 for LED strips SLIM
 RU Соединитель XC11 для лент LED SLIM
 UK Роз'єм XC11 для світлодіодних стрічок SLIM

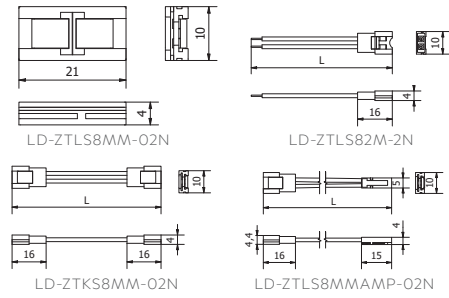

	INFO	cm		
LD-ZTLS8MM-02N	8 mm	-	tworzywo, plastic, пластик, пластик	5902801202377
LD-ZTKS8MM-02N		15 cm		5902801202230
LD-ZTLS82M-2N		200 cm		5902801202391
LD-ZTLS8MMAMP-02N		200 cm + mini AMP		5902801205392



PL Ładowarka indukcyjna z zasilaczem
 EN Wireless charger with power supply
 RU Беспроводное зарядное устройство с блоком питания
 UK Зарядний пристрій індукційний з блоком живлення



AE-ZUSB-20	czarny, black, черный, чорний	tworzywo, plastic, пластик, пластик	5901867181954



PL Ładowarka bezprzewodowa / indukcyjna, podblatowa z zasilaczem
 EN Wireless surface charger, under the countertop mount
 RU Беспроводное зарядное устройство, под столешницу
 UK Бездротовий зарядний пристрій під стільницю з блоком живлення



AE-ZLADPOD-20	czarny, black, черный, чорний	tworzywo, plastic, пластик, пластик	5902801031854



PL Ładowarka bezprzewodowa LUX z zasilaczem
 EN Inductive charger with a power feeder LUX
 RU Зарядное устройство индукционное с блоком питания LUX
 UK Зарядний пристрій індукційний з блоком живлення LUX

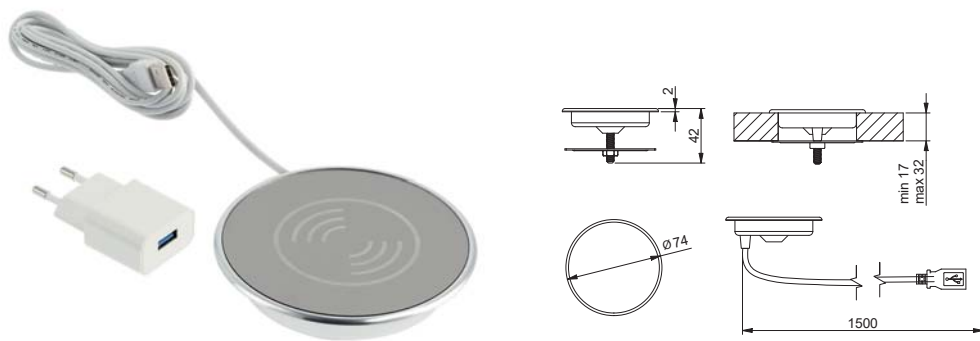

AE-ZLADLUX-40	chrom, chrome, хром, хром	tworzywo, plastic, пластик, пластик	5902801235153





PRZEDŁUŻACZE
POWER SOCKETS
УДЛИНИТЕЛИ
ПОДОВЖУВАЧІ

PL Przedłużacz biurkowy wpuszczany CHARGER
 EN Desk recessed power socket CHARGER
 RU Настольный удлинитель, встраиваемый CHARGER
 UK Настільний розетковий блок вбудований CHARGER

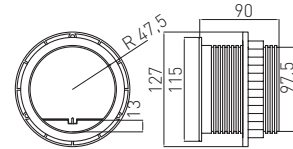

AE-BPW1S2UCH-80	100	1 x schuko	srebrny, silver, серебряный, срібний	tworzywo, plastic, пластик, пластик	5901867196439
AE-BPW1U2UCH-80		1 x french			5901867196422



PL Przedłużacz biurkowy wpuszczany CHARGER MINI
 EN Desk recessed power socket CHARGER MINI
 RU Настольный удлинитель, встраиваемый CHARGER MINI
 UK Настільний розетковий блок вбудований CHARGER MINI

360°



AE-BPW1S1UCH-53

AE-BPW1U1UCH-53

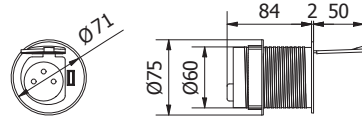

AE-BPW1U1UCH-53	60	1 x french	aluminium, aluminium, алюминий, алюміній	tworzywo, plastic, пластик, пластик	5902801253065
AE-BPW1S1UCH-53		1 x schuko			5902801253713



PL Przedłużacz biurkowy wpuszczany SLIDE
 EN Desk recessed power socket SLIDE
 RU Настольный удлинитель, встраиваемый SLIDE
 UK Настільний розетковий блок вбудований SLIDE

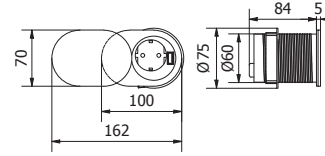

AE-BPW1U1UCH-51

AE-BPW1S1UCH-51



INFO



AE-BPW1U1UCH-51	USB 5V / 2,4A	french	aluminium, aluminium, алюминий, алюміній	tworzywo, plastic, пластик, пластик	5902801253027
AE-BPW1S1UCH-51		schuko			5902801252945



PL Przedłużacz biurkowy wpuszczany COMFORT
 EN Desk recessed power socket COMFORT
 RU Настольный удлинитель, встраиваемый COMFORT
 UK Настільний розетковий блок вбудований COMFORT

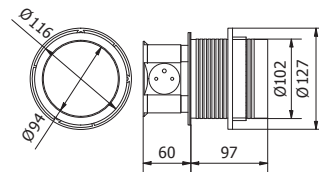

AE-BPW3S100U-53

AE-BPW4U100-53



INFO



AE-BPW4U100-53	100	-	1 x french	aluminium, aluminium, алюминий, алюміній	aluminium tworzywo, aluminium plastic, алюминий пластик, алюміній пластик	5902801252617
AE-BPW4S100-53			1 x schuko			5902801253003
AE-BPW3U100U-53			french			5902801253010
AE-BPW3S100U-53			1 x schuko			5902801252587



PL Przedłużacz biurkowy wpuszczany okrągły ø 100
 EN Pull-out power socket – round ø 100
 RU Выдвижной настольный удлинитель, круглый ø 100
 UK Настільний розетковий блок вбудований круглий ø 100



Black
Silver

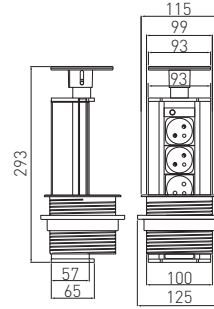

Folder	Ø mm	X	Icons	Material	Barcode
AE-BPW3GU-20	100	3 x french		czarny, black, черный, чорний	5908231338815
AE-BPW3GU-80				srebrny, silver, серебряный, срібний	5908231338808
AE-BPW3GS-20		3 x schuko		czarny, black, черный, чорний	5908231338839
AE-BPW3GS-80				srebrny, silver, серебряный, срібний	5908231338822



PL Przedłużacz biurkowy wpuszczany okrągły ø 60
 EN Pull-out power socket – round ø 60
 RU Выдвижной настольный удлинитель, круглый ø 60
 UK Настільний розетковий блок вбудований круглий ø 60



Black
Silver

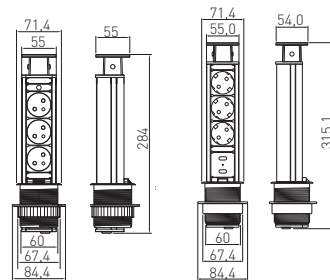

AE-BPW3U60U-20

AE-BPW3U60-80

Folder	Ø mm	X	Icons	Material	Barcode	
AE-BPW3U60-20	60	3 x french		czarny, black, черный, чорний	5908231395559	
AE-BPW3U60-80				srebrny, silver, серебряный, срібний	5908231395566	
AE-BPW3S60-20		3 x schuko		czarny, black, черный, чорний	5908231395535	
AE-BPW3S60-80				srebrny, silver, серебряный, срібний	5908231395542	
AE-BPW3U60U-20		5V USB		3 x french	czarny, black, черный, чорний	5901867130983
AE-BPW3U60U-80				srebrny, silver, серебряный, срібний	5901867131003	
AE-BPW3S60U-20				3 x schuko	czarny, black, черный, чорний	5901867130945
AE-BPW3S60U-80					srebrny, silver, серебряный, срібний	5901867130969



PL Przedłużacz biurkowy wpuszczany, prostokątny
 EN Rectangular pop-up power and connection socket
 RU Настольный удлинитель, прямоугольный, врезной
 UK Настільний розетковий блок вбудований прямокутний

360°



White

Black

Aluminium

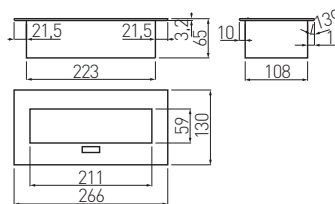

AE-PB03GS-53	-	3 x schuko	aluminium, aluminium, алюминий, алюміній	stal, tworzywo steel, plastic сталь, пластмасса сталь, пластик	5908231362605
AE-PB03GU-53	-	3 x french			5908231337689
AE-PBC3GU-53	1,5 m	3 x french	5908231389121		
AE-PBC3GU-20	1,5 m	3 x french	5902801023385		
AE-PBC3GU-10	1,5 m	3 x french	5901867130730		



PL Przedłużacz biurkowy wpuszczany, prostokątny
 EN Rectangular pop-up power and connection socket
 RU Настольный удлинитель, прямоугольный, врезной
 UK Настільний розетковий блок вбудований прямокутний

360°



White

Black

Aluminium

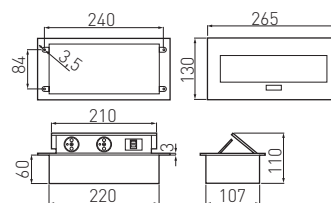

AE-PBU2GU-10	2 x french	biały, white, белый, білий	stal, tworzywo steel, plastic сталь, пластмасса сталь, пластик	5901867131010
AE-PBU2GU-20		czarny, black, черный, чорний		5901867131034
AE-PBU2GU-53		aluminium, aluminium, алюминий, алюміній		5902801265723



PL Przedłużacz biurkowy wpuszczany, prostokątny
 EN Rectangular pop-up power and connection socket
 RU Настольный удлинитель, прямоугольный, врезной
 UK Настільний розетковий блок вбудований прямокутний



AE-PB02GS-53



AE-PBC2GU-53

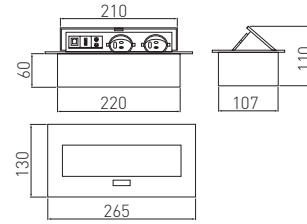

AE-PB02GS-53	-	2 x schuko	aluminium, aluminium, алюминий, алюміній	stal, tworzywo steel, plastic сталь, пластмасса сталь, пластик	5908231320513
AE-PB02GU-53	-	2 x french			5908231320520
AE-PBC2GU-53	1,5 m	2 x french			5901867175106



PL Przedłużacz biurkowy wpuszczany z HDMI
 EN Desk recessed power socket with HDMI port
 RU Настольный удлинитель, встраиваемый с выходом HDMI
 UK Настільний розетковий блок вбудований HDMI



AE-PB02GSHDMI-53



AE-PBC2GUHDMI-53



AE-PBC2GSHDMI-53

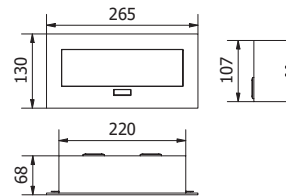

INFO



AE-PB02GSHDMI-53	1 x HDMI, USB data, 1 x RJ45	-	2 x schuko	aluminium, aluminium, алюминий, алюміній	stal, aluminium steel, aluminium сталь, алюминий	5902801026065
AE-PBC2GUHDMI-53	1 x HDMI	1,5 m	2 x french			5902801270703
AE-PBC2GSHDMI-53			2 x schuko			5902801270727



PL Przedłużacz biurkowy wpuszczany SOFT
 EN Desk recessed power socket SOFT
 RU Настольный удлинитель, встраиваемый SOFT
 UK Настільний розетковий блок вбудований SOFT



AE-PBSC3GS-10	3 x schuko	-	biały, white, белый, білий	stal, tworzywo steel, plastic	5902801252129
AE-PBSC3GS-20N			czarny, black, черный, чорний		5902801281730
AE-PBSC3GS-53			aluminium, aluminium, алюминий, алюміній		5902801252167
AE-PBSC3GU-10	3 x french	-	biały, white, белый, білий	stal, tworzywo steel, plastic	5902801252242
AE-PBSC3GU-20N			czarny, black, черный, чорний		5902801281716
AE-PBSC3GU-53			aluminium, aluminium, алюминий, алюміній		5902801251955
AE-PBSUC2GS-10	2 x schuko	5V USB max 2A	biały, white, белый, білий	stal, tworzywo steel, plastic	5902801252259
AE-PBSUC2GS-20N			czarny, black, черный, чорний		5902801281693
AE-PBSUC2GS-53			aluminium, aluminium, алюминий, алюміній		5902801252235
AE-PBSUC2GU-10	2 x french	-	biały, white, белый, білий	stal, tworzywo steel, plastic	5902801252440
AE-PBSUC2GU-20N			czarny, black, черный, чорний		5902801281761
AE-PBSUC2GU-53			aluminium, aluminium, алюминий, алюміній		5902801252815



PL Przedłużacz biurkowy bez kasety
 EN Through-desk power socket without housing
 RU Настольный удлинитель без корпуса
 UK Настільний розетковий блок без касети



AE-PBC3GS-51BK	3 x schuko	stal szczotkowana brushed steel	stal, aluminium, tworzywo steel, aluminium, plastic	5901867196613
AE-PBC3GU-51BK	3 x french	шліфована сталь matowana stal	stal, aluminium, tworzywo steel, aluminium, plastic	5901867196620



PL Przedłużacz biurkowy przepustowy z USB
 EN Through-desk power socket letterbox brush cable access with USB
 RU Настольный удлинитель с пропуском под кабель с USB
 UK Настільний розетковий блок наскрізний USB



AE-PBC3GS-53BKS



AE-PBC3GS2U-53BKS

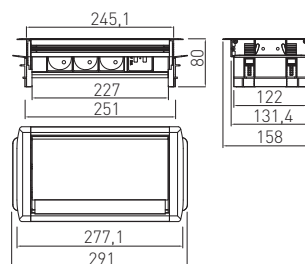

AE-PBC3GS-53BKS	3 x schuko	-	aluminium, aluminium, алюминий, алюміній	aluminium tworzywo, aluminium plastic, алюминий пластик, алюміній пластик	5901867196637
AE-PBC3GU-53BKS	3 x french	-			5901867196644
AE-PBC3GS2U-53BKS	3 x schuko	5V USB max 2A			5901867196651
AE-PBC3GU2U-53BKS	3 x french	5V USB max 2A			5901867196668



PL Przedłużacz biurkowy przepustowy z HDMI
 EN Through-desk power socket letterbox brush cable access with HDMI port
 RU Настольный удлинитель с пропуском под кабель, с выходом HDMI
 UK Настільний розетковий блок наскрізний HDMI



AE-PBC2GS1HDMI-53BKS



AE-PBC2GU1HDMI-53BKS

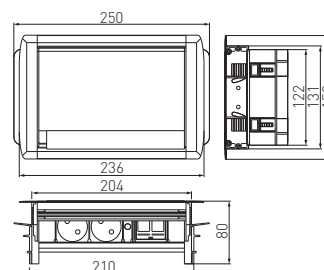

INFO



AE-PBC2GS1HDMI-53BKS	2 x schuko	1 x HDMI	aluminium, aluminium, алюминий, алюміній	aluminium tworzywo, aluminium plastic, алюминий пластик, алюміній пластик	5902801025792
AE-PBC2GU1HDMI-53BKS	2 x french				5902801025808



PL Przedłużacz biurkowy kątowy
 EN Corner power socket
 RU Настольный удлинитель, угловой
 UK Настільний розетковий блок кутовий



Folder	X	USB	Material	Barcode
AE-PBKT4U-80	4 x french	-	srebrny, silver, серебряный, срібний	5901867162779
AE-PBKT4S-80	4 x schuko	-		5901867162786
AE-PBKT3U2U-80	4 x french	5V USB max 2A		5901867162793
AE-PBKT3S2U-80	4 x schuko			5901867162809



PL Przedłużacz biurkowy kątowy MINI
 EN Corner power socket MINI
 RU Настольный удлинитель, угловой MINI
 UK Настільний розетковий блок кутовий MINI

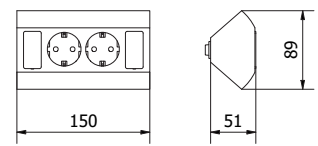

Folder	X	Material	Barcode
AE-PBKT2S-80	schuko	srebrny, silver, серебряный, срібний	5902801276361
AE-PBKT2F-80	french		5902801276323



- PL Przedłużacz biurkowy kątowny MINI z włącznikiem
 EN MINI corner power socket with switch
 RU MINI угловой удлинитель стола с выключателем
 UK Куттовий подовжувач MINI з вимикачем

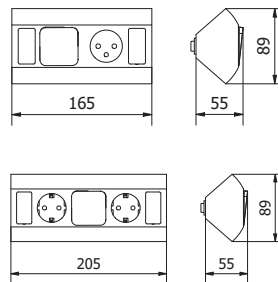

AE-PBKT1SW-80	schuko	srebrny, silver, серебряный, срібний	aluminium tworzywo, aluminium plastic, алюминий пластик, алюміній пластик	5902801276422
AE-PBKT1FW-80	french			5902801277368
AE-PBKT2SW-80	schuko			5902801276897
AE-PBKT2FW-80	french			5902801276453



- PL Przedłużacz biurkowy kątowny mini z regulatorem barwy
 EN MINI corner power socket with CCT controller
 RU MINI-удлинитель стола с цветным регулятором
 UK Куттовий подовжувач MINI з регулятором CCT

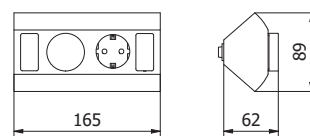

AE-PBKT1SCCT-80	schuko	srebrny, silver, серебряный, срібний	aluminium tworzywo, aluminium plastic, алюминий пластик, алюміній пластик	5902801276873
AE-PBKT1FCCT-80	french			5902801276934





PL Przedłużacz BOX
EN Power socket BOX
RU Удлинитель BOX
UK Подовжувач BOX

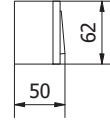
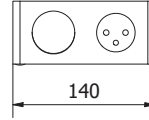

AE-PBOX1SW-80	schuko	srebrny, silver, серебряный, срібний	aluminium tworzywo, aluminium plastic, алюміній пластик, алюминій пластик	5902801276439
AE-PBOX1FW-80	french			5902801276385



PL Przedłużacz biurkowy MULTI
EN Power socket MULTI
RU Настольный удлинитель MULTI
UK Настільний розетковий блок MULTI



360°

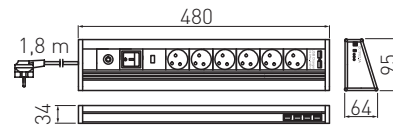

AE-PBMUL6U6U-53	6 x french	aluminium, aluminium, алюминий, алюминій	aluminium tworzywo, aluminium plastic, алюміній пластик, алюминій пластик	5901867196330
AE-PBMUL6S6U-53	6 x schuko			5901867196347





Przewodnik po symbolach katalogu | Guide to catalog symbols | Условные обозначения Умовні позначення в каталозі

Ikony elektrotechniczne | Electrical engineering icons | Электротехнические иконки | Іконки електротехнічні



Odpowiednik mocy
Wattage equivalent
Эквивалент мощности
Еквівалент потужності



Prąd znamionowy
Rated current
Номинальный ток
Номінальний струм



Moc źródła światła lub urządzenia
Light source or device power
Мощность источника света или устройства
Потужність джерела світла або пристрою



Strumień świetlny
Luminous flux
Луч свечения
Світловий потік



Długość produktu
Product length
Длина изделия
Довжина виробу



Materiał obudowy produktu
Product casing material
Материал корпуса продукта
Матеріал корпусу продукту



Kolor obudowy
Casing color
Цвет корпуса
Колір корпусу



Temperatura barwowa światła
Color temperature
Цветовая температура
Колірна температура світла



Maksymalna ilość opraw do połączenia w linie
Maximum unit in line connection
Максимальное количество светильников для подключения в линию
Максимальна кількість світильників, для підключення в лінії



Klasa energetyczna
Energy efficiency class
Класс энергоэффективности
Клас енергоефективності



Zasilanie
Voltage
Напряжение
Напряга



Zasilanie napięciem 12 V prąd stały
12 V power supply DC
Напряжение питания 12 В постоянный ток
Живлення напругою 12 В постійного струму



Zasilanie napięciem 12 V
12 V power supply
Напряжение питания 12 В
Живлення напругою 12 В



Napięcie wyjściowe
Output voltage
Выходное напряжение
Вихідна напруга



Maksymalne dopuszczalne obciążenie
Max permissible load
Максимально допустимая нагрузка
Максимально допустиме навантаження



Kąt świecenia
Beam angle
Угол свечения
Кут світіння



Stopień ochrony IP
International protection marking
Пылевлагозащита IP
Ступінь захисту IP



Czas pracy
Nominal lifetime
Время работы
Час роботи



Długość przewodu
Wire length
Длина провода
Довжина кабелю



Długość przewodu z wtyczką
Length of cord with plug
Длина провода с вилкой
Довжина кабелю з вилкою



Długość taśmy LED
LED strip length
Длина ленты LED
Довжина стрічки LED



Stopień ochrony IK
IK degree of protection
Пылевлагозащита IK
Ступінь захисту IK



Waga
Weight
Вес
Вага



Rodzaj złączki
Type of connector
Тип соединителя
Тип кріплення



Współczynnik oddawania barw
Colour rendering index
Индекс цветопередачи
Індекс передачі кольору



Współczynnik mocy
Power factor
Фактор силы
Коефіцієнт потужності



Współczynnik oślnienia
Unified glare rating
Кoefficient ослепленности
Коефіцієнт осліплення



Czas włączania
Starting time (max)
Время включения
Час вмикання

	Liczba cykli w/wył Switching cycle Количество циклов вкл./выкл. Кількість циклів вкл./выкл		Rekomendowana odległość montażu od powierzchni Recommended mounting distance from surfaces Рекомендується монтаж urządzenia на расстоянии Рекомендована відстань установки від поверхні
	Współpracuje ze ściemniaczami Dimmable Есть возможность подключения диммера Працює з диммерами		Średnica otworu montażowego Mounting hole diameter Монтажное отверстие диаметром Діаметр монтажного отвору
	Nie współpracuje ze ściemniaczami Non-dimmable Нет возможности подключения диммера Не працює з диммерами		Statecznik EVG Electrical ballast EVG Пусковое устройство EVG Баласт EVG
	Rodzaj diody LED Types of LED diode Тип диодов LED Тип світлодіодів		Brak efektu migotania Flicker free Нет мерцающего эффекта Відсутність ефекту мерехтіння
	Ilość diod LED Number of LED diodes Количество диодов LED Кількість світлодіодів		Możliwość montażu modułu awaryjnego CNBOP Ready for emergency unit assembly Возможность монтажа аварийного модуля CNBOP Можливість установки блоку аварійного CNBOP
	Dopuszczalna temperatura pracy Allowable working temperature Допустимая рабочая температура Допустима робоча температура		Pojemność baterii Battery capacity Емкость аккумулятора Ємність батареї
	Rodzaj świetłówki Type of fluorescent tube Тип люминесцентной лампы EVG Тип люмінесцентної лампи		Typ Baterii Battery type Тип батареи Тип батареї
	Przekrój przewodu Wire cross section Сечение провода Перетин дроту		Czujnik ruchu Motion sensor Датчик движения Датчик руху
	Maksymalny zasięg czujnika ruchu Motion sensor range Дальность датчика движения Максимальний радіус дії датчика руху		Czujnik zmierzchu Twilight sensor Датчик сумерек Сутінковий датчик
	Kąt widzenia czujnika ruchu Motion sensor detection angle Угол обзора датчика движения Кут огляду датчика руху		Długość przewodu z wtyczką mini AMP Length of the cable with mini connector Длина кабеля с мини-штекером AMP Довжина кабелю з mini AMP
	Zawartość rtęci Mercury content Содержание ртути Вміст ртуті		Długość przewodu z zasilaczem Length of the cable with driver Длина кабеля с блоком питания Довжина кабелю з блоком живлення
	Gniazdo Schuko Schuko socket Гнездо Schuko Розетка Schuko		Gniazdo RJ45 RJ45 socket Гнездо RJ45 Роз'єм RJ45
	Gniazdo French French socket Гнездо French Розетка French		Gniazdo ethernet Ethernet socket Гнездо ethernet Роз'єм ethernet
	USB USB port USB-порт USB-порт		Gniazdo HDMI HDMI socket Гнездо HDMI Роз'єм HDMI
	Ładowanie przez USB USB charge USB зарядка USB зарядка		Ilość gniazd Number of sockets Количество розеток Кількість слотів
	Maksymalne obciążenie gniazd USB Max load USB ports Максимальное количество портов USB Максимальне навантаження портів USB		Klasa ochronności I Protection class I I класс защиты Клас захисту I
	Gniazdo UK UK socket Гнездо UK Розетка UK		Klasa ochronności II Protection class II II класс защиты Клас захисту II
	Oprawa z włącznikiem Fixture with switch Светильник с выключателем Світильник з вимикачем		Klasa ochronności III Protection class III III класс защиты Клас захисту III
	Wyłącznik termiczny Thermal switch Термовыключатель Тепловий вимикач		Kostka przyłączeniowa - maksymalny przekrój przewodu Terminal block - maximum cable cross section Винтовой зажим - максимальное сечение кабеля Гвинтовий затиск - максимальний перетин кабелю



Maksymalny horyzont kąta działania czujnika
Maximum sensor angle operation
Максимальный горизонт угла наклона датчика
Максимальний горизонт кута дії датчика



Maksymalny prąd obciążenia
Maximum current load
Максимальный ток нагрузки
Максимальний струм навантаження



Miejsce montażu
Place of assembly
Место монтажа
Місце монтажу



Montaż natynkowy
Surface mounting
Поверхностный монтаж
Поверхневий монтаж



Montaż wpuszczany
Flush mount
Скрытый монтаж
Врізний монтаж



Czujnik jednobiegowy
Single-pole sensor
Однополюсный датчик
Однополюсний датчик



Czujnik dwubiegowy
Double-pole sensor
Двухполюсный датчик
Двополюсний датчик



Zabezpieczenie przepięciowe
Overvoltage protection
Защита от перенапряжения
Захист від перенапруги



Przycisk TEST
Test button
Кнопка TEST
Кнопка TEST



"Tryb pracy „na jasno”, oprawa zasilana ciągle – oprawa świeci zarówno podczas zasilania podstawowego jak i po jego zaniku"
"Maintained operating mode, luminaire is powered constantly - the luminaire illuminates both during power supply as well as after its shutting down"
Режим работы аварийного светильника, при котором светильник включен постоянно - светит как во время работы сети питания, так в случае ее нарушения
Режим роботи аварійного світильника, при якому світильник включений постійно - світить як під час роботи мережі живлення, так і в випадку порушення



"Tryb pracy „na ciemno”, oprawa zasilana nieciągle – oprawa świeci tylko po zaniku zasilania podstawowego"
Non-maintained operation mode, luminaire is not powered continuously - the luminaire illuminates only after power supply failure
Режим работы аварийного светильника, при котором светильник включается только при нарушении сети питания рабочего освещения
Режим роботи аварійного світильника, при якому світильник вмикається тільки після порушення мережі живлення робочого освітлення



"Tryb pracy przelączany – o świeceniu oprawy podczas obecności zasilania podstawowego decyduje zewnętrzny wyłącznik"
Switch mode is regulated by an external switch that determines if the luminaire illuminates while being connected to the grid
Комбинированный режим работы аварийного светильника, при котором работа светильника во время работы сети питания зависит от положения выключателя
Комбінований режим роботи аварійного світильника, при якому робота світильника під час роботи мережі живлення залежить від положення вимикача



Funkcja ZOOM
ZOOM function
Функция ZOOM
Функція ZOOM



Funkcja czerwonego światła ostrzegawczego
Red light warning function
Функция красной сигнальной лампы
Функція червоного попереджувального світла



Uchwyt magnetyczny
Magnetic handle
Магнитный держатель
Магнітний тримач



Trzy tryby świecenia
Three lighting modes
Три режима освещения
Три режими освітлення



Funcja flash
Flash function
Функция вспышки
Функція спалаху



Funkcja Power Bank
Power Bank function
Функция Power Bank
Функція Power Bank



Oprawa świecąca z dwóch stron
Two-sided luminaire



Двусторонний світильник
Двосторонній світильник



Mikrofalowy czujnik ruchu
Microwave motion sensor
Датчик движения СВЧ
Мікрохвильова датчик руху



3 sposoby świecenia: (zewn, wewn, zewn+wewn)
3 types of lighting: (outside, inside, outside + inside)
3 способа свечения: (внешн, внутр, внешн+внутр)
3 способи світіння: (зовніш, внутр, зовніш+внутр)



Czujnik ruchu IR
Motion Sensor IR
Датчик движения ИК
Датчик руху ІЧ



3-stopniowy czujnik ruchu
3 step motion sensor
3-ступенчатый датчик движения
3-ступінчастий датчик руху



TRI-COLOR

3 tryby załączania źródła światła
CCT 3 colour modes switch
3 режима регулировки цвета света источника света
3 режими колірної температури джерела світла



TRI-TONE

3-stopniowa regulacja jasności
3 step brightness adjustment
3-ступенчатая регулировка яркости
3-ступінчасте регулювання яскравості



DUO-COLOR

2 tryby załączania źródła światła
CCT 2 colour modes switch
2 режима регулировки цвета света источника света
2 режими колірної температури джерела світла



dimmable

Opcja ściemniania
Dimmable
Диммируемый
Регулювання яскравості

Ikony elektrotechniczne pozostałe - rodzaj trzonka
Electrical engineering icons – base type
Электротехнические иконки – тип цоколя
Електротехнічні значки інші-тип цоколя

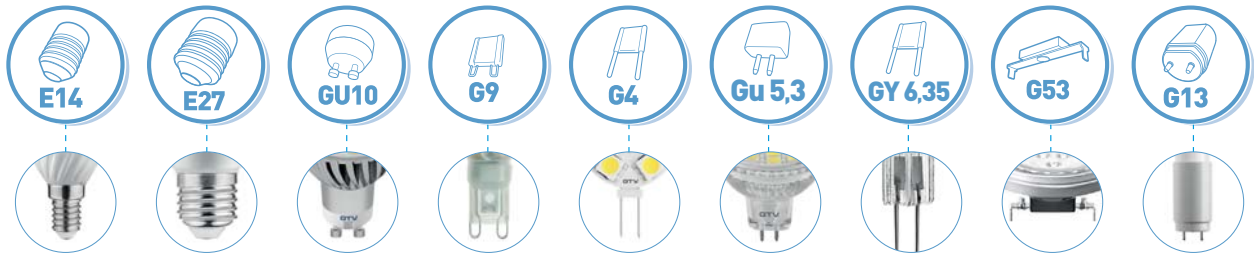

Na zamówienie wersja DALI
DALI on order
DALI на заказ
На замовлення версія DALI



Na zamówienie oprawa przystosowana do częstego załączania np. współpraca z czujkami ruchu.
Luminaire is compatible with motion detector on request
По заказу светильник предназначенный для работы с датчиками движения
На замовлення світильник, призначений для частого перемикування наприклад, робота з датчиками руху.



Maksymalna ilość opraw do połączenia w linie
Maximum unit in line connection
Максимальное количество светильников для подключения в линию
Максимальна кількість світильників, для підключення в лінії



Piktogramem oznaczone są łączniki, w których można podłączyć zasilanie szynoprzewodu.
Connectors that can be plugged into the grid are marked by this pictogram
Пиктограммой обозначены соединители, в которых можно подключить питание шинпровода.
Піктограмою позначені роз'єми, в яких можна підключити живлення шинпровода.



Możliwość podłączenia bez użycia narzędzi
No-tool connection option
Возможность подключения без инструментов
Можливість підключення без використання інструментів



Maksymalna rozpraszana moc źródeł światła dla profilu rozgrzanego do maksymalnie 65 stopni C, dla wersji z kloszem.*
Maximal dissipated power of lamps for heated profiles to 65°C, when applied with lampshades.*
Максимальная рассеиваемая мощность источников света для нагреваемого профиля до максимум 65 °C, для версии с абажуром.*
Максимальна розсіюється потужність джерел світла для профілю розпеченого максимум до 65 градусів C, для версії з плафоном.*



Brak efektu migotania
Flicker free
Нет мерцающего эффекта
Відсутність ефекту мерехтіння



Fukcja SOS, ZOOM
SOS, ZOOM function
Функция SOS, ZOOM
Функція SOS, ZOOM



Ładowanie bezprzewodowe
Wireless charging
Беспроводная зарядка
Бездротова зарядка



Współpracuje z modulem awaryjnym
Emergency module compatibility
Работает с модулем аварийного питания
Працює з аварійним модулем

* Rzeczywiste wartości mocy, strumienia świetlnego, temperatury barwowej mogą się różnić w granicach ±5% od podanych wartości. Maksymalna temperatura otoczenia dla powyższych wyników wynosi 24 stopnie C. Kompatybilność taśmy LED z profilem LED zależy od sposobu oraz miejsca montażu.
Real power value, luminous flux, colour temperature may vary within 5% of stated values. Maximal temperature of surroundings for above results is 24°C. Compatibility of LED tape and LED profile depends on a method and place of assembling.

Фактичне значення потужності, світлового потоку, кольорової температури можуть варіюватися в межах ± 5% від заданих значень. Максимальна температура оточуючої середовища для вищезазначених показателів становить 24°C. Совместимость светодиодной ленты со светодиодным профилем зависит от способа и места установки.

Фактичні значення потужності світлового потоку, колірної температури можуть варіюватися в межах ±5% від заданих значень. Максимальна температура навколишнього середовища для цих результатів становить 24 градуси C. Сумісність СВІТЛОДІОДНА стрічка з профілем LED, залежать від способу і місця монтажу.

A

AE-27GU10-00.....	284
AE-BPW1S1UCH-51.....	372
AE-BPW1S1UCH-53.....	371
AE-BPW1S2UCH-80.....	371
AE-BPW1U1UCH-51.....	372
AE-BPW1U1UCH-53.....	371
AE-BPW1U2UCH-80.....	371
AE-BPW3GS-20.....	373
AE-BPW3GS-80.....	373
AE-BPW3GU-20.....	373
AE-BPW3GU-80.....	373
AE-BPW3S60-20.....	373
AE-BPW3S60-80.....	373
AE-BPW3S60U-20.....	373
AE-BPW3S60U-80.....	373
AE-BPW3S100U-53.....	372
AE-BPW3U60-20.....	373
AE-BPW3U60-80.....	373
AE-BPW3U60U-20.....	373
AE-BPW3U60U-80.....	373
AE-BPW3U100U-53.....	372
AE-BPW4S100-53.....	372
AE-BPW4U100-53.....	372
AE-CANOPY-10.....	289
AE-CM3M00-00.....	269
AE-CM1000-00.....	268
AE-CM1500-00.....	271
AE-CM3000-00.....	269
AE-CM4000-00.....	270
AE-CM5000-00.....	270
AE-CM9000-00.....	271
AE-CM9000-10.....	271
AE-E14E27-00.....	284
AE-E14GU10-00.....	283
AE-E14RING-10.....	285
AE-E27E14-00.....	284
AE-E27RING-10.....	285
AE-E40E27-00.....	285
AE-GR610-10.....	222
AE-GSF2USB-10.....	274
AE-GSS2USB-10.....	274
AE-GU10E27-00.....	285
AE-MA8025-00.....	288
AE-MA8025-10.....	288
AE-MAS80X80-00.....	288
AE-MAS80X80-10.....	288
AE-OCEE14-00.....	281
AE-OCEE27-00.....	282
AE-OCEF27-00.....	281
AE-OCHT27-00.....	282
AE-OPE27K-00.....	282
AE-OPE27P-00.....	283
AE-PB02GS-53.....	375
AE-PB02GSHDMI-53.....	375
AE-PB02GU-53.....	375
AE-PB03GS-53.....	374
AE-PB03GU-53.....	374
AE-PBC2GS1HDMI-53BKS.....	377
AE-PBC2GSHDMI-53.....	375
AE-PBC2GU1HDMI-53BKS.....	377
AE-PBC2GU-53.....	375
AE-PBC2GUHDMI-53.....	375
AE-PBC3GS2U-53BKS.....	377
AE-PBC3GS-51BK.....	376
AE-PBC3GS-53BKS.....	377
AE-PBC3GU-10.....	374
AE-PBC3GU-20.....	374
AE-PBC3GU-51BK.....	376
AE-PBC3GU-53.....	374
AE-PBC3GU-53BKS.....	377
AE-PBKT3S2U-80.....	378
AE-PBKT3U2U-80.....	378
AE-PBKT4S-80.....	378
AE-PBKT4U-80.....	378
AE-PBKTM1FCCT-80.....	379
AE-PBKTM1FW-80.....	379
AE-PBKTM1SCCT-80.....	379
AE-PBKTM1SW-80.....	379
AE-PBKTM2F-80.....	378
AE-PBKTM2FW-80.....	379
AE-PBKTM2S-80.....	378
AE-PBKTM2SW-80.....	379
AE-PBMUL6S6U-53.....	380
AE-PBMUL6U6U-53.....	380
AE-PBOX1FW-80.....	380
AE-PBOX1SW-80.....	380
AE-PBSC3GS-10.....	376
AE-PBSC3GS-20N.....	376
AE-PBSC3GS-53.....	376
AE-PBSC3GU-10.....	376
AE-PBSC3GU-20N.....	376
AE-PBSC3GU-53.....	376
AE-PBSUC2GS-10.....	376
AE-PBSUC2GS-20N.....	376
AE-PBSUC2GS-53.....	376
AE-PBSUC2GU-10.....	376
AE-PBSUC2GU-20N.....	376
AE-PBSUC2GU-53.....	376
AE-PBU2GU-10.....	374
AE-PBU2GU-20.....	374
AE-PBU2GU-53.....	374
AE-PF3G1M-00.....	276
AE-PF3G3M-00.....	276
AE-PF3G5M-00.....	276
AE-PF5G3M-00.....	276
AE-PF5G5M-00.....	276
AE-PFBEBEN-20.....	277
AE-PFBEBEN-40.....	277
AE-POGRODUN-10.....	278
AE-POGRODUN-20.....	278
AE-POGRODUN-30.....	278
AE-PS3G3M-00.....	276
AE-PS3G5M-00.....	276
AE-PS4G3M-00.....	276
AE-PS4G5M-00.....	276
AE-PS5G3M-00.....	276
AE-PS5G5M-00.....	276
AE-RU0102-00.....	279
AE-RU0103-00.....	281
AE-RU0121-00.....	279
AE-SBEBEN-30.....	277
AE-SBEBEN-50.....	277
AE-SC0102-00.....	280
AE-SC0103-00.....	280
AE-SRC812-00.....	273
AE-SRC812-MIN.....	272
AE-SRC812-MIN2.....	272
AE-VA1UNI-00.....	280
AE-WBBUNI-10DIM.....	358
AE-WBCUNI-10DIM.....	358
AE-WBEZDB-10S.....	356
AE-WBEZDC-10S.....	356

AE-WBEZDK15-10.....	356
AE-WBEZD-NB.....	359
AE-WBEZDPIR2-20.....	357
AE-WBEZDPIR-10.....	357
AE-WDBP1-10.....	355
AE-WDBP1-20.....	355
AE-WDBP2CCT-10.....	355
AE-WDBP2CCT-20.....	355
AE-WDSB-10DIM.....	358
AE-WDSC-10DIM.....	358
AE-WLB01-10.....	360
AE-WLC01-20.....	360
AE-WLIP44-15.....	361
AE-WLKON-20.....	361
AE-WLLAN1-10.....	362
AE-WLPR-60.....	360
AE-WLPR-60P2.....	360
AE-WLSZN1-10.....	363
AE-WPDRW-00.....	359
AE-ZLADLUX-40.....	369
AE-ZLADPOD-20.....	369
AE-ZUSB-20.....	368

B

BK-BHL050-1000BZ.....	292
BK-BHL060-1300BZ.....	292
BK-PUL030A-0700AD.....	292
BK-PUL042A-0700BD.....	292
BK-PUL042A-1100AD.....	292
BK-PUL060A-2000AD.....	292

C

CR-CO1000-00.....	264
CR-CR3M00-00.....	259
CR-CR4L00-00.....	260
CR-CR5M00-00.....	261
CR-CR9M00-00.....	263
CR-CR9M00-10.....	263
CR-CR1000-00.....	258
CR-CR1000-10.....	258
CR-CR1100-00.....	264
CR-CR1400-00.....	265
CR-CR2000-00.....	258
CR-CR2000-10.....	258
CR-CR3000-00.....	259
CR-CR5000-00.....	260
CR-CR6000-00.....	261
CR-CR7000-00.....	262
CR-CR8000-00.....	262
CR-CR9000-00.....	263
CR-CR9000-10.....	263
CR-CR13000-00.....	265
CR-CR15000-00.....	266
CR-CR16000-00.....	266
CR-CR17000-00.....	267
CR-CR18000-00.....	267
CR-CR19000-00.....	268
CZ-CZ1000-00.....	273
CZ-CZ2000-00.....	274

G

GZ-E27000-00.....	283
GZ-E27000-10.....	283

GZ-G90000-00.....	279
GZ-GZ10-0000.....	278
GZ-MR16-0000.....	278

K

KB-W310HUG-20.....	290
KB-W313HUG-20.....	290

L

LB-GAL3WRU-10.....	229
LB-GAL5WM0-10.....	230
LB-GAL5WRU-10.....	229
LD-3SCTA60-10W.....	30
LD-3SDA60-10W.....	30
LD-3SDA606-10W.....	30
LD-3SKL-CBN.....	339
LD-3SKL-NBN.....	339
LD-3SKL-ZBN.....	339
LD-120G14W-32.....	38
LD-120G14W-40.....	38
LD-120G18W-32.....	38
LD-120G18W-40.....	38
LD-2835-24V-300-20-CB.....	300
LD-2835-24V-300-20-NE4300.....	300
LD-2835-24V-300-20-ZB.....	300
LD-2835-24V-600-20-CB.....	300
LD-2835-24V-600-20-NE4300.....	300
LD-2835-24V-600-20-ZB.....	300
LD-2835-60-60-20-CCT.....	299
LD-2835-300-20-CB.....	298
LD-2835-300-20-CB-50.....	300
LD-2835-300-20-CBN.....	298
LD-2835-300-20-NE4N.....	298
LD-2835-300-20-NE4P.....	298
LD-2835-300-20-NE4P-50300.....	298
LD-2835-300-20-ZB.....	298
LD-2835-300-20-ZB-50.....	300
LD-2835-300-20-ZBN.....	298
LD-2835-300-65-CB.....	298
LD-2835-300-65-CBN.....	298
LD-2835-300-65-NE4N.....	298
LD-2835-300-65-ZB.....	298
LD-2835-300-65-ZBN.....	298
LD-2835-600-5MM-20-CB299.....	299
LD-2835-600-5MM-20-NE4299.....	299
LD-2835-600-5MM-20-ZB.....	299
LD-2835-600-20-CB.....	298, 299
LD-2835-600-20-NE4298.....	299
LD-2835-600-20-ZB.....	298, 299
LD-2835-600-65-CB.....	298, 299
LD-2835-600-65-ZB.....	298, 299
LD-3014-1200-20-CB.....	299
LD-3014-1200-20-NE4.....	299
LD-3014-1200-20-ZB.....	299
LD-3528-300-20-CB.....	298
LD-3528-300-20-CB-50.....	300
LD-3528-300-20-NE4P.....	298
LD-3528-300-20-NE4P-50300.....	298
LD-3528-300-20-NI.....	298
LD-3528-300-20-ZB.....	298
LD-3528-300-20-ZB-50.....	300
LD-3528-300-65-CB.....	298
LD-3528-600-20-CB.....	298
LD-3528-600-20-ZB.....	298

LD-3528-600-65-CB.....	298	LD-CS36CB-53.....	325	LD-GL40060UGR-NB.....	60	LD-KWP27CB-53.....	330
LD-3528-600-65-ZB.....	298	LD-CS36NE-53.....	325	LD-GL40060UGR-NBS.....	60	LD-KWP27ZB-53.....	330
LD-5050-300-20-CB.....	299	LD-CS36ZB-53.....	325	LD-GL40120-NB.....	60	LD-LCG319-40.....	329
LD-5050-300-20-ZB.....	299	LD-DAL100W-NB.....	123	LD-GL40120-NBS.....	60	LD-LCG319-52.....	329
LD-5050-300-65-CB.....	299	LD-DAL150W-NB.....	123	LD-HAG136-30.....	138	LD-LCG319-53.....	329
LD-5050-300-65-ZB.....	299	LD-DC24A60-12.....	32	LD-HAG158-30.....	138	LD-LE35WB-NB.....	165
LD-5630-300-20-CB.....	299	LD-DE40062-NB.....	64	LD-HAG218-30.....	138	LD-LE35WC-NB.....	165
LD-5630-300-20-ZB.....	299	LD-DE40062UGR-NB.....	64	LD-HAG236-30.....	138	LD-LIV40WNB-00.....	162
LD-5630-300-65-CB.....	299	LD-DE40062UGR-NB.....	64	LD-HAG236KL-ME.....	139	LD-LIV40WNB-10.....	162
LD-5630-300-65-ZB.....	299	LD-DELOR6W0-NB.....	94	LD-HAG258-30.....	138	LD-LN36W60-NB.....	59
LD-A60CM3-10W.....	29	LD-DELOR6WC-NB.....	95	LD-HB150W-40.....	121	LD-LN40W60UGR-NB.....	59
LD-A60CM4-10W.....	29	LD-DELOW6W0-NB.....	94	LD-HEL136B-30.....	138	LD-LOG16W-LED.....	90
LD-A60CZ3-10W.....	29	LD-DELOW6WC-NB.....	95	LD-HEL218B-30.....	138	LD-LU16CB-53.....	323
LD-A60CZ4-10W.....	29	LD-DIMLED-10.....	362	LD-HEL236B-30.....	138	LD-LU16NE-53.....	323
LD-A60FL8-30.....	35	LD-E14P35W-30.....	28	LD-HEL258B-30.....	138	LD-LU16ZB-53.....	323
LD-A60FL8M-30.....	34	LD-E14S2W0-40.....	28	LD-HER60W12-NB.....	70	LD-LUG319-40.....	329
LD-AB18CB-53.....	334	LD-EIW09CB-CZ.....	335	LD-ILUXC10W-64.....	118	LD-LUG319-52.....	329
LD-AB18ZB-53.....	334	LD-EMP24W-40.....	84	LD-ILUXC20W-64.....	118	LD-LUG319-53.....	329
LD-AKO4060-NB.....	58	LD-EMP24W-40KW.....	84	LD-ILUXC30W-64I.....	118	LD-LUM120-30P.....	73
LD-AL7A60-20W.....	34	LD-EMP24WM-40.....	85	LD-ILUXC50W-64.....	118	LD-LUM150-30P.....	73
LD-AL24CB-53.....	327	LD-EMP24WM-40KW.....	85	LD-ILUXC100W-64.....	118	LD-LUN40WNB-00-A.....	162
LD-AL24NE-53.....	327	LD-ES11100-30*.....	46	LD-ILUXCC10W-64.....	118	LD-LUN40WNB-10-A.....	162
LD-AL24ZB-53.....	327	LD-ES11101-30.....	46	LD-ILUXCC20W-64.....	118	LD-MAN07W-CBP.....	99
LD-ALF100-30W.....	40	LD-ES11101-40.....	46	LD-ILUXCC30W-64.....	118	LD-MAN07W-NBP.....	99
LD-ALF120-40W.....	40	LD-ES11110-30*.....	46	LD-ILUXCC50W-64.....	118	LD-MAN13W-CBP.....	99
LD-ALF140-50W.....	40	LD-ES11110-40.....	46	LD-ILUXCC100W-64.....	118	LD-MAN13W-NBP.....	99
LD-ALT20W-NB.....	113	LD-ES11115-30.....	46	LD-IMAXC200W-64.....	115	LD-MAN19W-CBP.....	99
LD-ALT35W-NB.....	113	LD-ES11115-40.....	46	LD-INEXT10W-64.....	116	LD-MAN19W-NBP.....	99
LD-AR11120-30.....	47	LD-ES11175-30.....	46	LD-INEXT20W-64.....	116	LD-MAN24W-CBP.....	99
LD-AR11145-30*.....	47	LD-ES11175-40.....	46	LD-INEXT30W-64.....	116	LD-MAN24W-NBP.....	99
LD-ARC15W-NB.....	113	LD-ES11177-30*.....	46	LD-INEXT30WP-64.....	116	LD-MAW03W-CBP.....	99
LD-ARC25W-NB.....	113	LD-ESKA084-51.....	203	LD-INEXT50W-64.....	116	LD-MAW03W-NBP.....	99
LD-ARC30W-NB.....	113	LD-ESKB084-51.....	203	LD-INEXT50WP-64.....	116	LD-MAW07W-CBP.....	99
LD-ARZ18W-CCT.....	110	LD-ESOA084-51.....	202	LD-IRUSB-53.....	337	LD-MAW07W-NBP.....	99
LD-ARZ25W-CCT.....	110	LD-ESOB084-51.....	202	LD-J7806W-40.....	45	LD-MAW13W-CBP.....	99
LD-ARZ35W-CCT.....	110	LD-FAR10W-40.....	112	LD-J11810W-40.....	45	LD-MAW13W-NBP.....	99
LD-ATL16KW-40.....	83	LD-FAR20W-40.....	112	LD-JAS15W-40.....	75	LD-MAW19W-CBP.....	99
LD-ATL16OK-40.....	82	LD-FL36CB-00.....	336	LD-KABE2M-00.....	290, 363	LD-MAW19W-NBP.....	99
LD-BA2E27-00.....	221	LD-FL36ZB-00.....	336	LD-KABE2M-10.....	290	LD-MAW24W-CBP.....	99
LD-BA2GU10-0M.....	221	LD-FRT36WB-NB.....	164	LD-KALU100K-40.....	92	LD-MAW24W-NBP.....	99
LD-BALE27-00.....	221	LD-G4P35W-30.....	48	LD-KALU100W-40.....	92	LD-MAX60CB-40N.....	334
LD-BALGU10-0S.....	221	LD-G4P35W-40.....	48	LD-KAN150W-NB.....	123	LD-MAX60ZB-40N.....	334
LD-BERGA50W-30.....	69	LD-G4S115-32.....	48	LD-KAN200W-NB.....	123	LD-MCR12W-NB.....	91
LD-BERGA70W-30.....	69	LD-G4S115-45.....	48	LD-KAR18W-CCT.....	112	LD-ML1000-00.....	339
LD-BES24WKW-30.....	79	LD-G9P5W0-30.....	42	LD-KAR25W-CCT.....	112	LD-ML2000-00.....	340
LD-BES24WKW-40.....	79	LD-G9P5W0-40.....	42	LD-KJVCB-CB.....	324	LD-ML3000-00.....	340
LD-BES24WOK-30.....	79	LD-G9P7W0-30.....	42	LD-KJVCB-ZB.....	324	LD-ML4000-00.....	341
LD-BES24WOK-40.....	79	LD-G9P7W0-40.....	42	LD-KLPCB-00N.....	338	LD-ML5000-00.....	341
LD-BETISD50W-30.....	69	LD-G9P35W-30.....	42	LD-KLPNB-00N.....	338	LD-MOON12W-NB.....	82
LD-BETISD70W-30.....	69	LD-G9P35W-40.....	42	LD-KLPZB-00N.....	338	LD-MOON18W-NB.....	82
LD-BLRKW18W-61.....	102	LD-G45FL2E-30.....	38	LD-KNG24063-CB.....	62	LD-MZ12WKW-NB.....	100
LD-BLRK18W-61.....	102	LD-G45FL4-30.....	27	LD-KNG24063-NB.....	62	LD-MZ12WOK-NB.....	100
LD-BNC8WKB-NB.....	166	LD-G45FL4E-30.....	38	LD-KNG42060-CB.....	62	LD-MZ18WKW-NB.....	100
LD-BNC8WKC-NB.....	166	LD-G45FL4M-30.....	27	LD-KNG42060-NB.....	62	LD-MZ18WOK-NB.....	100
LD-BNC8WOB-NB.....	166	LD-G93W24-32.....	41	LD-KNG42312-CB.....	62	LD-NESSAGU10D-20.....	216
LD-BNC8WOC-NB.....	166	LD-G93W24-45.....	41	LD-KNG42312-NB.....	62	LD-NESSAGU10D-80.....	216
LD-BOS1CBWB-53.....	338	LD-G93W25-30.....	41	LD-KNG45060-NB.....	62	LD-NESSAGU10J-20.....	216
LD-BOS1CBWG-53.....	338	LD-G93W25-40.....	41	LD-KNG45312-NB.....	62	LD-NESSAGU10J-80.....	216
LD-C35FL4-30.....	25	LD-G95FL8-30.....	35	LD-KONMINI-RGB.....	349	LD-NGU10P-3W.....	43
LD-C35FL4-30L.....	26	LD-G95FV4-30.....	36	LD-KONML-MONO.....	351	LD-NGU10P-4W.....	43
LD-C35FL4M-30.....	24	LD-G125FL8-30.....	35	LD-KONML-MONO-PAN.....	353	LD-NGU10PN-1W.....	43
LD-C35FL4M-30L.....	26	LD-G125FV4-30.....	36	LD-KONML-MONO-PIL.....	352	LD-NGU10PN-3W.....	43
LD-CHIC16NE-10.....	337	LD-G4015W-30.....	48	LD-KONML-RGBW.....	351	LD-NGU10PN-4W.....	43
LD-CHIC16NE-20.....	337	LD-G4020W-30.....	48	LD-KONML-RGBW-PIL.....	353	LD-NKW18CB-40.....	336
LD-CORSO1-00.....	130	LD-G96440-32.....	41	LD-KONML-WIFI.....	352	LD-NKW18ZB-40.....	336
LD-CORSO3-00.....	130	LD-G96440-45.....	41	LD-KONML-WRGB-PAN.....	354	LD-NO24CB-00.....	335
		LD-GL40060-NB.....	60				

LD-NO24ZB-00.....	335	LD-PARK2L50W-40.....	125	LD-SMNBD45B-80.....	27	LD-TWW09W-CB.....	104
LD-NPCT809W-40.....	76	LD-PARK2L80W-40.....	125	LD-SMNBD45-80.....	39	LD-TWW16W-CB.....	104
LD-NPCT818W-40.....	76	LD-PC2A60-6W.....	32	LD-SMNC37L-80.....	25	LD-UFO18W-30.....	39
LD-NPCT818W-BL.....	76	LD-PC2A60-8W.....	33	LD-SMNDC37-80.....	24	LD-UFO18W-40.....	39
LD-NPCT818W-GR.....	76	LD-PC2A60-12.....	33	LD-SMNGB45B-30.....	26	LD-VA24CB-53.....	323
LD-NPCT818W-RD.....	76	LD-PC2A60RGBW-8W.....	30	LD-SMNGB45B-60.....	26	LD-VA24NE-53.....	323
LD-NPCT836W-40.....	76	LD-PC3A60-10W.....	33	LD-SMNGB45C-60.....	39	LD-VA24ZB-53.....	323
LD-OBP27CB-53.....	330	LD-PC3A60-15W.....	34	LD-SMNGC30B-30.....	24	LD-VALLA8W-40.....	214
LD-OBP27ZB-53.....	330	LD-PC6010-30.....	44	LD-SMNGC30B-60.....	24	LD-VALLA12W-40.....	214
LD-OGLA3W-00.....	131	LD-PC6010-40.....	44	LD-SMNGC30C-60.....	38	LD-VE15CB-53.....	326
LD-OJVCOB-CB.....	324	LD-PC6010-64.....	44	LD-SMNGC30L-60.....	25	LD-VE15CBZB-53.....	326
LD-OLL20W-CB.....	75	LD-PC7510-30.....	44	LD-SO206W-NB.....	106	LD-VE15NE-53.....	326
LD-OLL20W-NB.....	75	LD-PC7510-40.....	44	LD-SO212W-NB.....	106	LD-VE15ZB-53.....	326
LD-OLL40W-CB.....	75	LD-PC7510-64.....	44	LD-SO218W-NB.....	106	LD-VE2060N-25.....	65
LD-OLL40W-NB.....	75	LD-PIRUSB-53.....	337	LD-SO224W-NB.....	106	LD-VE2120N-50.....	65
LD-OLL50W-CB.....	75	LD-PJVCOB-CB.....	325	LD-SPCA60-10W.....	32	LD-VE4060N-50.....	65
LD-OLL50W-NB.....	75	LD-PN2A60-8W.....	33	LD-SPCGU10-7W.....	43	LD-VE4060W-50.....	65
LD-OME30WNB-10-L.....	160	LD-PN2A60-12.....	33	LD-SPNA60-10W.....	32	LD-VEW06W-CB.....	106
LD-OME30WNB-10-T.....	160	LD-PN3A60-10W.....	33	LD-SPNGU10-7W.....	43	LD-VEW12W-CB.....	106
LD-OME50WNB-10-A.....	160	LD-PN3A60-15W.....	34	LD-SR16CB-53.....	333	LD-VEW18W-CB.....	106
LD-OME50WNB-10-C.....	160	LD-PRM10WB-NB.....	165	LD-SR16NE-53.....	333	LD-VIL42WUDB-NB.....	164
LD-OMN060-30B.....	72	LD-PRM10WC-NB.....	165	LD-SR16ZB-53.....	333	LD-VIL42WUDC-NB.....	164
LD-OMN120-60B.....	72	LD-PRM10WS-NB.....	165	LD-ST64FV4-30.....	36	LD-VIPERS30W-40.....	115
LD-OMN120-75M.....	72	LD-PZ2A60-12.....	33	LD-STARS24W-NB.....	80	LD-VIPERS50W-40.....	115
LD-OMN150-70B.....	72	LD-PZ3A60-10W.....	33	LD-STARS48W-NB.....	80	LD-VIPERS100W-40.....	115
LD-OMN150-90M.....	72	LD-R5060W-30.....	28	LD-STEL080W-40.....	125	LD-VIPERS150W-40.....	115
LD-ONT120-36.....	74	LD-R5060W-40.....	28	LD-STEL150W-40.....	125	LD-VLRKW0538-CB.....	108
LD-ONTEND-00.....	74	LD-R6380W-30.....	29	LD-SZ1510-30.....	43	LD-VLRKW0538-NB.....	108
LD-ONTMCI-00.....	74	LD-R6380W-40.....	29	LD-SZ1510-40.....	43	LD-VLRKW1038-CB.....	108
LD-ONTPWR-00.....	74	LD-RA60CB-40N.....	333	LD-SZ1510-64.....	43	LD-VLRKW1038-NB.....	108
LD-OP408C-53.....	331	LD-RA60ZB-40N.....	333	LD-SZ5010-30.....	44	LD-VLRK0538-CB.....	108
LD-OP456C-53.....	332	LD-RGB-150-20.....	299	LD-SZ5010-40.....	44	LD-VLRK0538-NB.....	108
LD-OP609C-53.....	332	LD-RGB-150-65.....	299	LD-SZ5010-64.....	44	LD-VLRK1038-CB.....	108
LD-OPD5W0-CB.....	332	LD-SAHER1-DUO.....	129	LD-SZAHQ06W-MA.....	345	LD-VLRK1038-NB.....	108
LD-OPD9W0-CB.....	332	LD-SAHER3-DUO.....	129	LD-SZAHQ15W-MA.....	345	LD-WEND13W-40.....	89
LD-OPT30S-53N.....	328	LD-SATU12W-NB.....	83	LD-SZAHQ30W-MA.....	345	LD-WEND18W-40.....	89
LD-OPT60S-51N.....	328	LD-SATU18W-NB.....	83	LD-SZAHQ50W-MA.....	345	LD-WEND24W-40.....	89
LD-OPT60S-53N.....	328	LD-SATU24W-NB.....	83	LD-SZAHQ75W-MA.....	345	LD-WENDM18W-40.....	89
LD-ORN07W-CBP.....	97	LD-SATU45W-NB.....	83	LD-TERNO1-00.....	130	LD-WENDM24W-40.....	89
LD-ORN07W-NBP.....	97	LD-SILVAGU10D-20.....	217	LD-TERNO3-00.....	130	LD-WENUSD13-LED.....	88
LD-ORN13W-CBP.....	97	LD-SILVAGU10D-80.....	217	LD-TIAGOGU10D-01.....	220	LD-WL2457-53.....	331
LD-ORN13W-NBP.....	97	LD-SILVAGU10J-20.....	217	LD-TIAGOGU10D-01KW.....	218	LD-WZA20W-NW.....	347
LD-ORN19W-CBP.....	97	LD-SILVAGU10J-80.....	217	LD-TIAGOGU10D-20.....	220	LD-WZA36W-NW.....	347
LD-ORN19W-NBP.....	97	LD-SM1210-10.....	45	LD-TIAGOGU10D-20KW.....	218	LD-WZA60W-NW.....	347
LD-ORN24W-CBP.....	97	LD-SM1210N-10.....	45	LD-TIAGOGU10J-01.....	220	LD-WZA80W-NW.....	347
LD-ORN24W-NBP.....	97	LD-SM4016-30.....	47	LD-TIAGOGU10J-01KW.....	218	LD-WZA150W-NW.....	347
LD-ORW03W-CBP.....	97	LD-SM4016-64.....	47	LD-TIAGOGU10J-20.....	220	LD-Z3CSCB-53.....	328
LD-ORW03W-NBP.....	97	LD-SM6016-30*.....	47	LD-TIAGOGU10J-20KW.....	218	LD-Z5CSCB-53.....	329
LD-ORW07W-CBP.....	97	LD-SMB45B-80.....	27	LD-TIG34W60-NB.....	58	LD-ZAC6WDE-RGB.....	350
LD-ORW07W-NBP.....	97	LD-SMBD45-80.....	39	LD-TK100W-40.....	122	LD-ZAS24PRO80W-30.....	344
LD-ORW13W-CBP.....	97	LD-SMBKW09W-21.....	101	LD-TOK16WD-40.....	86	LD-ZAS75W-30.....	344
LD-ORW13W-NBP.....	97	LD-SMBKW16W-21.....	101	LD-TOK16WP-40.....	87	LD-ZAS150-NW.....	346
LD-ORW19W-CBP.....	97	LD-SMBKW24W-21.....	101	LD-TOK22W-00.....	86	LD-ZAS350-NW.....	346
LD-ORW19W-NBP.....	97	LD-SMBK09W-21.....	101	LD-TOK22WD-40.....	86	LD-ZASPRO07W-30.....	343
LD-ORW24W-CBP.....	97	LD-SMBK16W-21.....	101	LD-TOR08W-NB.....	110	LD-ZASPRO12W-30.....	343
LD-ORW24W-NBP.....	97	LD-SMBK20W-21.....	101	LD-TOR12W-NB.....	110	LD-ZASPRO16W-30.....	343
LD-OSA16WD-40.....	87	LD-SMC37L-80.....	25	LD-TOR20W-NB.....	110	LD-ZASPRO24W-30.....	343
LD-OSA22WD-40.....	87	LD-SMDC37-80.....	24	LD-TOR24W-NB.....	110	LD-ZASPRO33W-30.....	343
LD-OZE218-00.....	137	LD-SMGB45B-30.....	26	LD-TR24CB-53.....	327	LD-ZASPRO54W-30.....	343
LD-OZE218-01.....	137	LD-SMGB45B-60.....	26	LD-TR24NE-53.....	327	LD-ZASPRO65W-30.....	343
LD-OZE236-00.....	137	LD-SMGB45C-60.....	39	LD-TR24ZB-53.....	327	LD-ZASPRO80W-30.....	343
LD-OZE236-01.....	137	LD-SMGC30B-30.....	24	LD-TWI10WOK-40.....	93	LD-ZASPU15W-30N.....	347
LD-PAR10W40-00.....	214	LD-SMGC30B-60.....	24	LD-TWI10WOW-40.....	93	LD-ZFPL24W06-NB.....	73
LD-PAR10W40-10.....	214	LD-SMGC30C-60.....	38	LD-TWN09W-CB.....	104	LD-ZFPL48W12-NB.....	73
LD-PARK2L30W-40.....	125	LD-SMGC30L-60.....	25	LD-TWN16W-CB.....	104	LD-ZL5RGB150-00.....	350

LD-ZSKL15-00N.....	348	OP-ALSOK-00.....	200	OP-PROD4-01.....	192	OS-MARMO38-00.....	224
LD-ZTK8MM-02N.....	366	OP-ALSOK-10.....	200	OP-PROD4-02.....	192	OS-MILA00A-00.....	205
LD-ZTK8MM-02N600.....	366	OP-ALSOK-52.....	200	OP-PROD4-21.....	192	OS-MILA00U-00.....	205
LD-ZTK10MM-02N.....	366	OP-AURKWB-10.....	201	OP-PROD4-30.....	192	OS-MILA10P-00.....	205
LD-ZTKS8MM-02N.....	368	OP-AURKWC-00.....	201	OP-SALKW-10.....	197	OS-MILA45P-00.....	205
LD-ZTKT8MM-02N.....	366	OP-AURKWS-52.....	201	OP-SALOK-10.....	197	OS-OSL1120S-00.....	133
LD-ZTKT8MM-02N600.....	366	OP-AUROKB-10.....	201	OS-AER20W-00.....	168	OS-OSL1150S-00.....	133
LD-ZTKT10MM-02N.....	366	OP-AUROKC-00.....	201	OS-AER20W-10.....	168	OS-OSL2120S-00.....	134
LD-ZTKTRGB-04N.....	366	OP-AUROKS-52.....	201	OS-ASTRITE27-20.....	208	OS-OSL2150S-00.....	134
LD-ZTL8MM-02N.....	365	OP-OPRKW1-20.....	196	OS-ASTRITE27-80.....	208	OS-PLCRKM-00.....	141
LD-ZTL8MM-02N600.....	365	OP-OPRKW1-80.....	196	OS-AV8085KW1-00.....	169	OS-PLCRKZ-00.....	142
LD-ZTL8MMAMP-02N.....	367	OP-OPRKWT-10.....	195	OS-AV8085KW1-10.....	169	OS-PLCZMI-00.....	141
LD-ZTL8MMAMP-02N600.....	367	OP-OPRKWT-21.....	195	OS-AV8085OK1-00.....	169	OS-PSL02E27-80.....	142
LD-ZTL10MM-02N.....	365	OP-OPROK1-20.....	196	OS-AV8085OK1-10.....	169	OS-PSLX2E27-80.....	143
LD-ZTL82M-2N.....	367	OP-OPROK1-80.....	196	OS-AV80160KW2-00.....	170	OS-REN20WKW1-00.....	180
LD-ZTL82M-2N600.....	367	OP-OPROKR-10.....	195	OS-AV80160KW2-10.....	170	OS-REN20WKW1-10.....	180
LD-ZTL102M-2N.....	367	OP-OPROKR-21.....	195	OS-AV80160OK2-00.....	170	OS-REN20WKW2-00.....	180
LD-ZTLR2B2M-4N.....	367	OP-PADRK1-01.....	190	OS-AV80160OK2-10.....	170	OS-REN20WKW2-10.....	180
LD-ZTLR2B-04N.....	365	OP-PADRK1-10.....	190	OS-BLN50W1-00.....	176	OS-RINGO1-00.....	143
LD-ZTLS8MM-02N.....	368	OP-PADRK1-21.....	190	OS-BLN50W1-10.....	176	OS-SAKES111-00.....	181
LD-ZTLS8MMAMP-02N.....	368	OP-PADRK1-52.....	190	OS-BLN50W2-00.....	177	OS-SAKES111-10.....	181
LD-ZTLS82M-2N.....	368	OP-PADRK1-61.....	190	OS-BLN50W2-10.....	177	OS-SAKES111KW-00.....	181
LD-ZWND6W-10.....	348	OP-PADST1-01.....	189	OS-BLN50W3-00.....	177	OS-SAKES111KW-10.....	181
LD-ZWND12-10.....	348	OP-PADST1-10.....	189	OS-BLN50W3-10.....	177	OS-SAN20WOK1-00.....	179
LD-ZZAS07PROKD6.....	345	OP-PADST1-21.....	189	OS-CAM40WG9KW-00.....	184	OS-SAN20WOK1-10.....	179
LD-ZZAS12PROKD6.....	345	OP-PADST1-52.....	189	OS-CAM40WG9KW-10.....	184	OS-SAN20WOK2-00.....	179
LD-ZZAS16PROKD6.....	345	OP-PADST1-61.....	189	OS-CAM40WG9OK-00.....	184	OS-SAN20WOK2-10.....	179
LD-ZZAS24PROKD6.....	345	OP-PALACEDKW-10.....	198	OS-CAM40WG9OK-10.....	184	OS-SEL236-ZHQ.....	291
LD-ZZAS33PROKD6.....	345	OP-PALACEDKW-20.....	198	OS-DIEGOGU10-20.....	224	OS-SEL418-ZHQ.....	291
LK-OMEGA-OP.....	160	OP-PALACEDOK-10.....	198	OS-DIEGOGU10-80.....	224	OS-SEN5087OKB-10.....	173
LK-PANELX4-00.....	66	OP-PALACEDOK-20.....	198	OS-DRAGO14-00.....	174	OS-SEN5087OKCZ-00.....	173
LP-BENFICA2-00.....	230	OP-PALACEKW-10.....	199	OS-DRAGO14-10.....	174	OS-SEN5097KWB-10.....	173
LP-BENFICA2-10.....	230	OP-PALACEKW-20.....	199	OS-DRAGO18-00.....	174	OS-SEN5097KWCZ-00.....	173
LP-BENFICA2-80.....	230	OP-PALACEOK-10.....	199	OS-DRAGO18-10.....	174	OS-SEND5083OKB-10.....	174
LT-LA8WT2-60.....	153	OP-PALACEOK-20.....	199	OS-FRG20W-00.....	178	OS-SEND5083OKCZ-00.....	174
LT-LB3WT4-60.....	153	OP-PAST1-01.....	187	OS-FRG20W-00-MINI.....	178	OS-SEN5081OKB-10.....	172
LT-LB6WT2-60.....	152	OP-PAST1-02.....	187	OS-FRG20W-10.....	178	OS-SEN5081OKCZ-00.....	172
LT-LB8WT6-60.....	152	OP-PAST1-10.....	187	OS-FRG20W-10-MINI.....	178	OS-SEN5091KWB-10.....	172
LT-LC6WT3-60.....	154	OP-PAST1-21.....	187	OS-GRA0DA-00.....	206	OS-SEN5091KWCZ-00.....	172
LT-LK3WBL-60.....	151	OP-PAST1-30.....	187	OS-GRA00P-00.....	207	OS-STA422-00.....	290
LT-LKSZ3W-60.....	151	OP-PAST2-01.....	188	OS-GRA0UA-00.....	206	OS-STA465-00.....	290
LZ-25MM00-00.....	287	OP-PAST2-02.....	188	OS-HERZW1-00.....	139	OS-TENGU10-00.....	167
LZ-40MM00-00.....	287	OP-PAST2-10.....	188	OS-IBBL060-00.....	144	OS-TENGU10-10.....	167
LZ-60MM00-00.....	287	OP-PAST2-21.....	188	OS-IBKR060-00.....	144	OS-TENGU10KW-00.....	167
LZ-100MM0-00.....	287	OP-PAST2-30.....	188	OS-ITL12WKW-LED.....	91	OS-TENGU10KW-10.....	167
LZ-160MM0-00.....	287	OP-PIREN1-00.....	182	OS-ITL12W-LED.....	90	OS-TMG30CM-00.....	211
LZ-250MM0-00.....	287	OP-PIREN1-20.....	182	OS-ITL16W-LED.....	90	OS-TOS0DA-00.....	208
LZ-AKZ312-10N.....	364	OP-PIREN2-00.....	182	OS-KACROO-00.....	145	OS-VENTANAH-00.....	212
LZ-AKZ612-10N.....	365	OP-PIREN2-20.....	182	OS-KAG508-10.....	150	OS-VENTANAU-00.....	212
LZ-KAPR2M-10.....	364	OP-PIREO1-20.....	183	OS-KAM060-00.....	146		
LZ-KOI2KO-10.....	287	OP-PIREO1-81.....	183	OS-KAM060-10.....	146		
O		OP-PIREO2-20.....	183	OS-KAN527-24.....	149		
OA-MALEDPAN-00.....	293	OP-PIREO2-81.....	183	OS-KAN527-24M.....	149		
OA-SALED1-08.....	129	OP-PRAN5-01.....	193	OS-KAX527-10.....	150		
OA-SALED3-08.....	129	OP-PRAN5-02.....	193	OS-KAY060-10.....	145		
OH-ST2500-23.....	289	OP-PRAN5-21.....	193	OS-LAG20W-00.....	168		
ON-ALFAKGU10-06.....	226	OP-PRAN5-30.....	193	OS-LAG20W-10.....	168		
ON-ALFAKGU10-06-MINI.....	226	OP-PRAN6-01.....	194	OS-LE150NJ-01.....	133		
ON-ALFAO-C1W.....	227	OP-PRAN6-02.....	194	OS-MARINADA-00.....	210		
ON-ALFAO-C2W.....	227	OP-PRAN6-21.....	194	OS-MARINAH-00.....	212		
ON-ALFAOGU10-06.....	226	OP-PRAN6-30.....	194	OS-MARINAP-00.....	211		
ON-ALFAOGU10-06-MINI.....	226	OP-PROD3-01.....	191	OS-MARINAP3-00.....	211		
OP-ALSKW-00.....	200	OP-PROD3-02.....	191	OS-MARINAUA-00.....	210		
OP-ALSKW-10.....	200	OP-PROD3-21.....	191	OS-MARMO25-00.....	224		
OP-ALSKW-52.....	200	OP-PROD3-30.....	191	OS-MARMO28-00.....	224		

P

PA-CPGLAXAH-00.....	301, 302, 303
PA-CPGLAXAV-00301, 302, 303	
PA-CPGLAXL-00301, 302, 303	
PA-GLAX3M-AL.....	310
PA-GLAX-AL.....	310
PA-GLAX-AL-10.....	310
PA-GLAX-AL-20M.....	310
PA-GLAX-AL-90.....	310
PA-GLAXDR-AL.....	312
PA-GLAXGKL3M-00.....	301
PA-GLAXGKS3M-00.....	301
PA-GLAXGKW3M-00.....	302
PA-GLAXGKWK3M-00.....	302

Niniejszy katalog produktów został przygotowany przez GTV Poland. Poprzez ciągłe udoskonalanie swojej oferty, zgodnie z wymogami rynkowymi i prawnymi, GTV Poland zastrzega sobie prawo do wprowadzania zmian w przedstawionym asortymencie. Prezentowana publikacja nie jest ofertą w rozumieniu Kodeksu Cywilnego. Rzeczywiste produkty mogą odbiegać od poglądowych zdjęć i rysunków zamieszczonych w publikacji. GTV Poland zastrzega sobie prawo do zmian i błędów w druku.

This product catalogue has been prepared by GTV Poland. Constantly improving its products so as to follow market and legal requirements, GTV Poland reserves the right to introduce changes in the presented product range. The present publication does not constitute an offer within the meaning of the Civil Code. The real products can differ from the example photographs and drawings in the publication. GTV Poland reserves the right to make changes and printing errors.

Данный каталог был создан компанией GTV Poland. В соответствии с действующим законодательством и требованиями рынка, компания GTV Poland оставляет за собой право вносить изменения в ассортимент предлагаемого товара. Данная публикация носит информационно-ознакомительный характер и не является коммерческим предложением в понимании права. Компания не несет ответственности за возможные цветовые расхождения, опечатки и неточности.

Даний каталог був створений компанією GTV Poland. Відповідно до чинного законодавством і вимогами ринку, компанія GTV Poland залишає за собою право вносити зміни в асортимент пропонуваного товару. Дана публікація носить інформаційно-ознайомчий характер і не є комерційною пропозицією в розумінні права. Компанія не несе відповідальності за можливі колірні розбіжності, помилки і неточності.

GTV

ul. Przejazdowa 21
05-800 Pruszków
Poland

 + 48 22 44 47 595

 + 48 22 44 47 527

 + 420 591 160 091

 ООО 140073, РФ, «ГТВ РУС.»
Московская область,
Люберецкий район, пос.Томилино,
Микрорайон Птицефабрика, Литер 7А
+ 7 495 640 15 88

 GTV Czech Distribution s.r.o.
СТPark Ostrava, Na Rovince 879
720 00 Ostrava Hrabová
Česká republika
+ 420 591 160 091

   + 48 22 444 72 88; + 48 22 444 75 52

     + 48 22 444 73 38; + 48 882 439 628

fax: + 48 22 444 75 01
e-mail: oswietlenie@gtv.com.pl
e-mail: east.lighting@gtv.com.pl

www.gtv.com.pl

Follow us on

