

NILSON®

sihirli dokunuş...

magic touch...

магическое прикосновение...



2020 **BROŞÜR**
BROCHURE
БРОШЮРА





NEW MODEL
YENİ

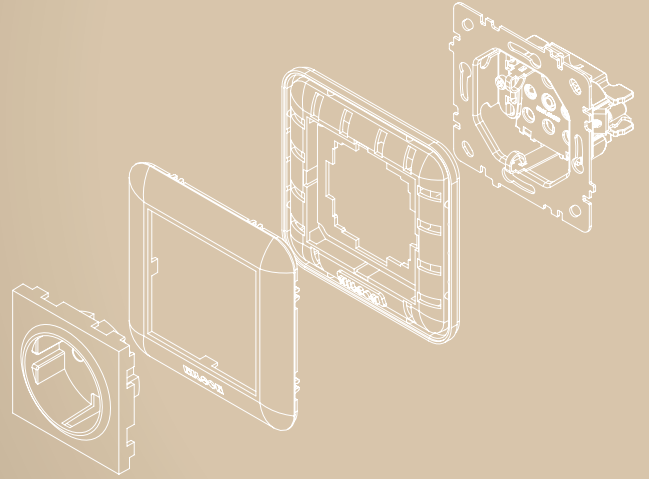

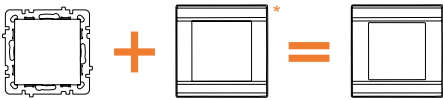

* ÇERÇEVE yatay veya dikey uygulanabilir.
 FRAME can be applied horizontally or vertically.
 РАМКА может применяться горизонтально или вертикально.

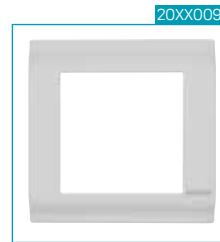
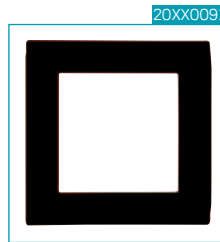
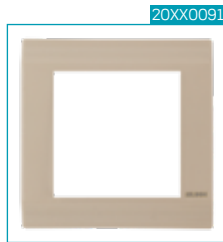
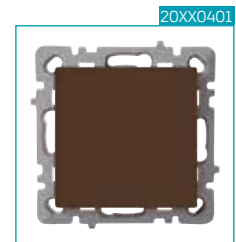
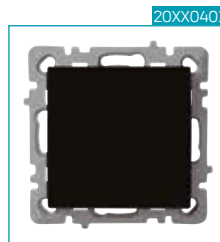
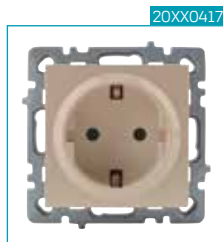
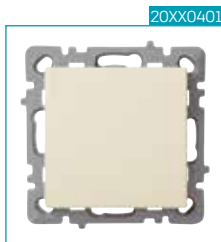

XX=11 Beyaz-White-Белый

XX=12 Krem-Cream-Кремовый

XX=17 Dore-Dore-Доре

XX=22 Siyah-Black-Чёрный

XX=40 Gri-Gray-Серый

XX=46 Kahverengi-Brown-Коричневый

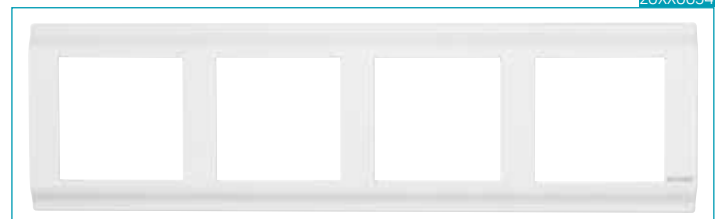
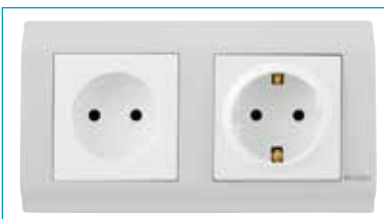
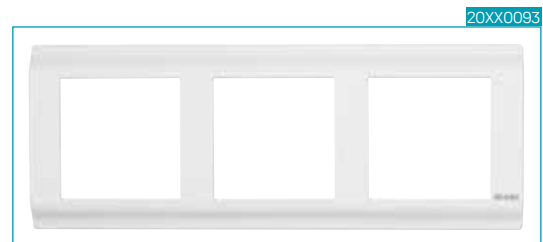

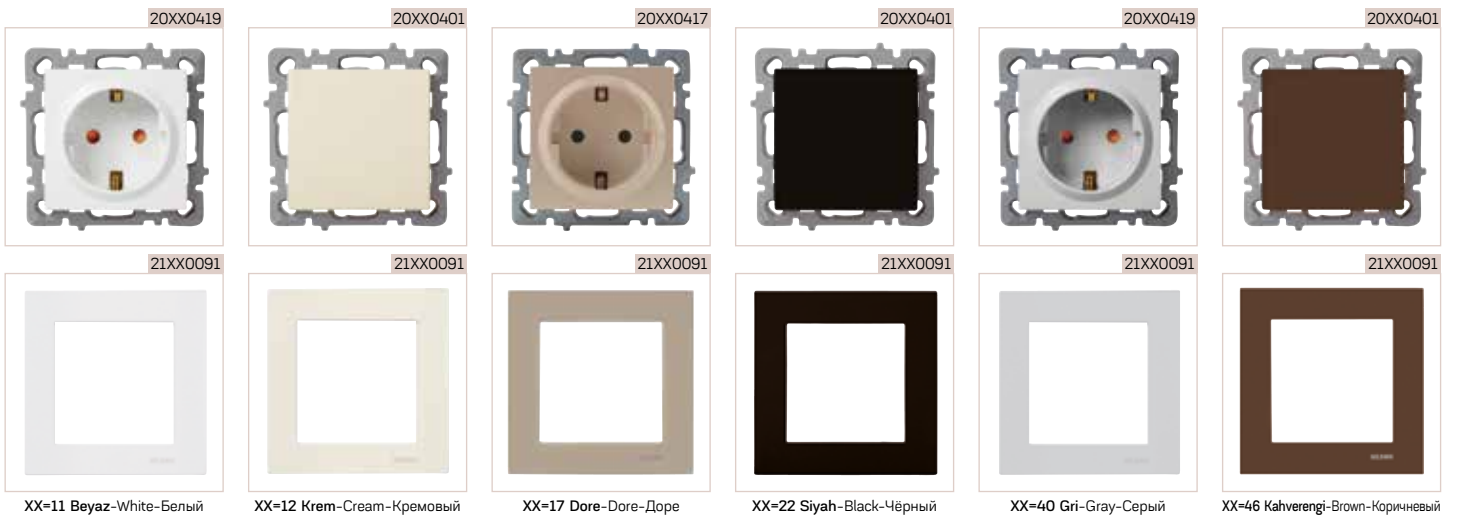
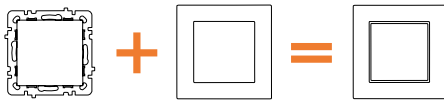

NEW PRODUCT
YENİ

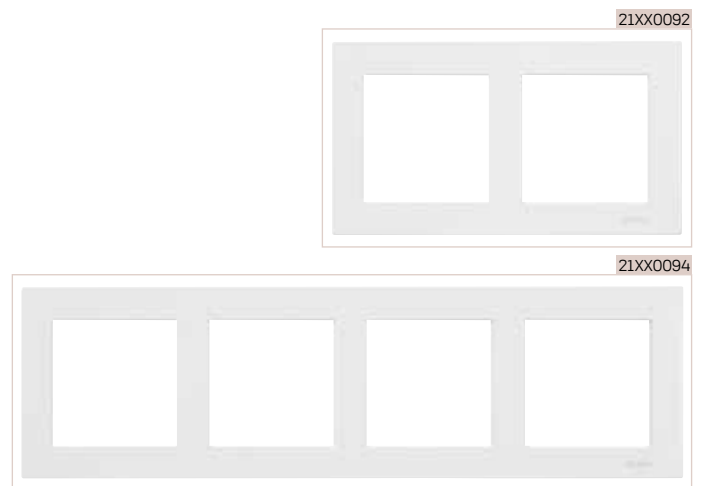

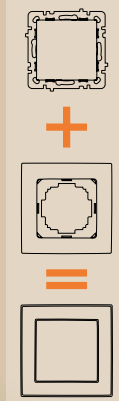

24XX0417

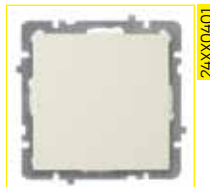

24XX0401



24XX0417

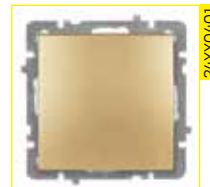

24XX0401



24XX0417



24XX0091



24XX0091

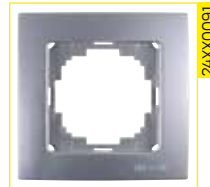

24XX0091



24XX0091



24XX0091

XX-11 Beyaz-White-Belый

XX-12 Krem-Cream-Kremovый

XX-13 Gümüş-Silver-Cеребро

XX-15 Altın-Gold-Золото

XX-16 Fıme-Anthrachite-Антрацит



24XX0406



24XX0401



24XX0417



24XX0417



24XX0401

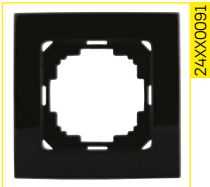

24XX0091



24XX0091



24XX0091



24XX0091



24XX0091

(XX) 22 Siyah-Black-Чёрный

XX-25 Meşe-Oak-Дуб

XX-26 Kiraz-Cherry-Черешня

XX-27 Ceviz-Walnut-Орех

XX-28 Akcağaç-Maple-Клён

24XX0092

24XX0093

24XX0095



24XX0094

24XX0096



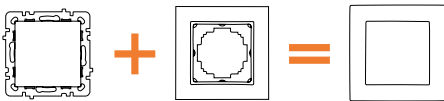

24XX0481



24XX0419



24XX0401



24XX0456



24XX0422



24XX0414



25XX0091



25XX0091



25XX0091



25XX0091



25XX0091



25XX0091

XX=11 Beyaz-White-Белый

XX=12 Krem-Cream-Кремовый

XX=13 Gümüş-Silver-Серебро

XX=15 Altın-Gold-Золото

XX=16 Fıme-Anthrachite-Антрацит

XX=22 Siyah Black-Чёрный



25XX0092



25XX0093



25XX0094

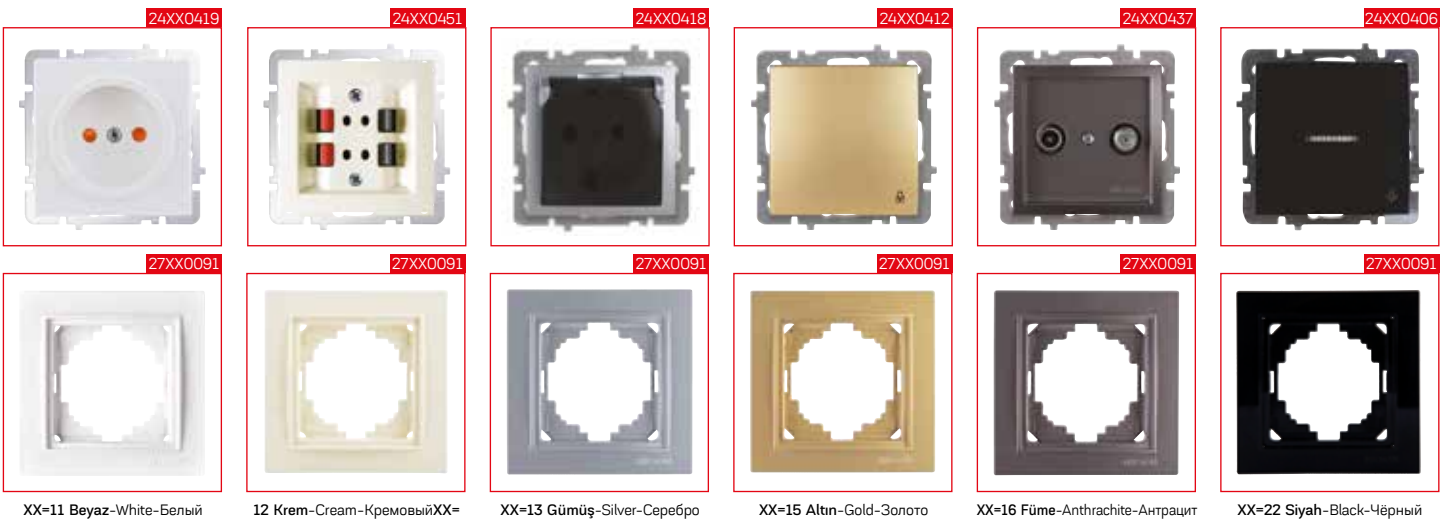
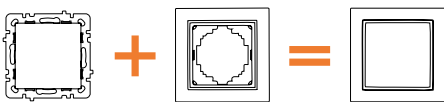

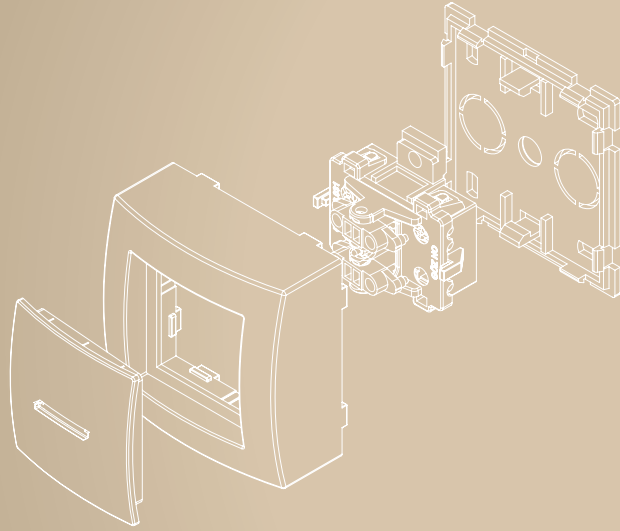

XX-



11 Beyaz
White-Белый



12 Krem
Cream-Кремовый



13 Gümüş
Silver-Серебро



15 Altın
Gold-Золото



16 Füme
Anthracite-Антрацит



25 Meşe
Oak-Дуб



26 Kiraz
Cherry-Черешня



27 Ceviz
Walnut-Орех



28 Akşaağaç
Maple-Клён

26XX1001



26XX1002



26XX1003



26XX1004



26XX1005



26XX1006



26XX1007



26XX1008



26XX1011



26XX1012



26XX1013



26XX1014



26XX1015



26XX1017



26XX1018



26XX1021



26XX1022



26XX1024



26XX1025



26XX1032



26XX1033



26XX1034



26XX1035



26XX1062



26XX1044



26XX1045

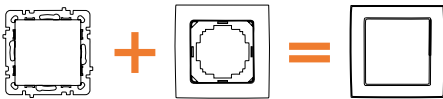

XX-11 Beyaz-White-Белый



XX-12 Krem-Cream-Кремовый



XX-13 Gümüş-Silver-Серебро



XX-15 Altın-Gold-Золото



XX-16 Fıme-Anthrachite-Антрацит



XX-22 Siyah-Black-Чёрный



STN Saten-Satin-Сатин



KRM Krom-Chrome-Хром





ALT Altın-Gold-Золото

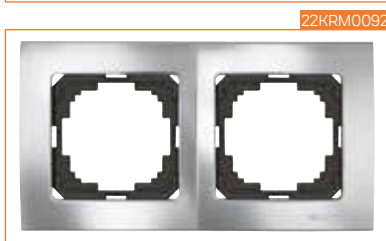

FME Fıme-Anthrachite-Антрацит

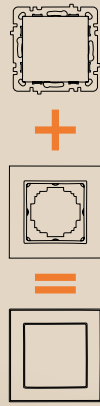



| | | | | | |
|--|---|--|--|---|--|
|  24XX0401 XX=11 Beyaz-White-Белый |  24XX0417 XX=12 Krem-Cream-Кремовый |  24XX0465 XX=13 Gümüş-Silver-Серебро |  24XX0466 XX=15 Altın-Gold-Золото |  24XX0410 XX=16 Fıme-Anthrachite-Антрацит |  24XX0435 XX=22 Siyah-Black-Чёрный |
|  25WH0091 WH Beyaz-White-Белый |  25BR0091 BR Bronz-Bronze-Бронза |  25BB0091 BB Bambu-Bamboo-Бамбук |  25WN0091 WN Ceviz-Walnut-Опек |  25AN0091 AN Altın-Gold-Золото |  25BZ0091 BZ Bronz-Bronze-Бронза |
|  25MP0091 MP M.Point-M.Point-Мастерпойнт |  25BL0091 BL Siyah-Black-Чёрный |  25CY0091 CY Kiraz-Cherry-Черешня |  25WE0091 WE Venge-Wenge-Венге |  25GS0091 GS Gümüş-Silver-Серебро |  25SH0091 SH Siyah-Black-Чёрный |
|  25MP0093 | | |  25MP0094 | | |
|  25MP0092 | |  25MP0095 | | | |



9
32881009



12
32881012



18
32881018



24
32881024



36
32881036

SIVA ÜSTÜ / SURFACE MOUNTED / НАРУЖНОЙ УСТАНОВКИ



9
32661009



12
32661012



18
32661018



24
32661024



36
32661036

SIVA ALTI / FLUSH MOUNTED / ВНУТРЕННЕЙ УСТАНОВКИ



1

30441001



1-2

30441002



3-4

30441003

SIVA ÜSTÜ / SURFACE MOUNTED / НАРУЖНОЙ УСТАНОВКИ



2

30441102



4

30441104



6

30441006



9

30441009



12

30441012



16

30441016



24

30441024



36

30441036

SIVA ÜSTÜ / SURFACE MOUNTED / НАРУЖНОЙ УСТАНОВКИ



2

30331102



4

30331104



6

30331006



9

30331009



12

30331012



16

30331016



24

30331024



36

32331036

SIVA ALTI / FLUSH MOUNTED / ВНУТРЕННЕЙ УСТАНОВКИ

XX= 02 - 2mt / 03 - 3mt / 05 - 5mt

42130000



İKİLİ TOPRAKSIZ
2 WAY SOCKET / 2 ГНЕЗДА БЕЗ ЗАЗЕМЛЕНИЯ

421300XX



42132000



İKİLİ ÇOCUK KORUMALI TOPRAKSIZ
2 WAY SOCKET WITH CHILD PROTECTION / 2 ГНЕЗДА БЕЗ ЗАЗЕМЛЕНИЯ И 3/ШТОРКОЙ

421320XX



42130100



İKİLİ TOPRAKLI
2 WAY EARTHED SOCKET / 2 ГНЕЗДА С ЗАЗЕМЛЕНИЕМ

421301XX



42132100



İKİLİ TOPRAKLI, ÇOCUK KORUMALI
2 WAY EARTHED SOCKET WITH CHILD PROTECTION / 2 ГНЕЗДА С ЗАЗЕМЛЕНИЕМ И 3/ШТОРКОЙ

421321XX



42131100



İKİLİ TOPRAKLI, ANAHTARLI
2 WAY EARTHED SOCKET WITH SWITCH / 2 ГНЕЗДА С ЗАЗЕМЛЕНИЕМ, КНОПКОЙ

421311XX



42133100



İKİLİ TOPRAKLI, ANAHTARLI, ÇOCUK KORUMALI
2 WAY EARTHED SOCKET WITH CHILD PROTECTION+SWITCH / 2 ГНЕЗДА С ЗАЗЕМЛЕНИЕМ, КНОПКОЙ С 3/ШТОРКОЙ

421331XX



43130000



ÜÇLÜ TOPRAKSIZ
3 WAY SOCKET / 3 ГНЕЗДА БЕЗ ЗАЗЕМЛЕНИЯ

431300XX



43132000



ÜÇLÜ ÇOCUK KORUMALI TOPRAKSIZ
3 WAY SOCKET WITH CHILD PROTECTION / 3 ГНЕЗДА БЕЗ ЗАЗЕМЛЕНИЯ И 3/ШТОРКОЙ

431320XX



43130100



ÜÇLÜ TOPRAKLI
3 WAY EARTHED SOCKET / 3 ГНЕЗДА С ЗАЗЕМЛЕНИЕМ

431301XX



43132100



ÜÇLÜ TOPRAKLI, ÇOCUK KORUMALI
3 WAY EARTHED SOCKET WITH CHILD PROTECTION / 3 ГНЕЗДА С ЗАЗЕМЛЕНИЕМ И 3/ШТОРКОЙ

431321XX



43131100



ÜÇLÜ TOPRAKLI, ANAHTARLI
3 WAY EARTHED SOCKET WITH SWITCH / 3 ГНЕЗДА С ЗАЗЕМЛЕНИЕМ, КНОПКОЙ

431311XX



43133100



ÜÇLÜ TOPRAKLI, ANAHTARLI, ÇOCUK KORUMALI
3 WAY EARTHED SOCKET WITH CHILD PROTECTION+SWITCH / 3 ГНЕЗДА С ЗАЗЕМЛЕНИЕМ, КНОПКОЙ С 3/ШТОРКОЙ

431331XX



XX= 02 - 2mt / 03 - 3mt / 05 - 5mt



44130000



441300XX



44132000



421320XX

DÖRTLÜ TOPRAKSIZ
4 WAY SOCKET / 4 ГНЕЗДА БЕЗ ЗАЗЕМЛЕНИЯ

DÖRTLÜ ÇOCUK KORUMALI TOPRAKSIZ
4 WAY SOCKET WITH CHILD PROTECTION / 4 ГНЕЗДА БЕЗ ЗАЗЕМЛЕНИЯ И 3/ШТОРКОЙ



44130100



441301XX



44132100



441321XX

DÖRTLÜ TOPRAKLI
4 WAY EARTHED SOCKET / 4 ГНЕЗДА С ЗАЗЕМЛЕНИЕМ

DÖRTLÜ TOPRAKLI, ÇOCUK KORUMALI
4 WAY EARTHED SOCKET WITH CHILD PROTECTION / 4 ГНЕЗДА С ЗАЗЕМЛЕНИЕМ И 3/ШТОРКОЙ



44131100



441311XX



44133100



441331XX

DÖRTLÜ TOPRAKLI, ANAHTARLI
4 WAY EARTHED SOCKET WITH SWITCH / 4 ГНЕЗДА С ЗАЗЕМЛЕНИЕМ, КНОПКОЙ

DÖRTLÜ TOPRAKLI, ANAHTARLI, ÇOCUK KORUMALI
4 WAY EARTHED SOCKET CHILD PROTECTION+SWITCH / 4 ГНЕЗДА С ЗАЗЕМЛЕНИЕМ, КНОПКОЙ С 3/ШТОРКОЙ



44132200



441322XX



44133200



441332XX

DÖRTLÜ ÇOCUK KORUMALI UPS
4 WAY UPS SOCKET WITH CHILD PROTECTION / 4 ГНЕЗДА С 3/ШТОРКОЙ+UPS

DÖRTLÜ ANAHTARLI, ÇOCUK KORUMALI UPS
4 WAY UPS SOCKET WITH CHILD PROTECTION+SWITCH / 4 ГНЕЗДА С 3/ШТОРКОЙ, КНОПКОЙ+UPS



46130100



461301XX



46132100



461321XX

ALTILI TOPRAKLI
6 WAY EARTHED SOCKET / 6 ГНЕЗД С ЗАЗЕМЛЕНИЕМ

ALTILI TOPRAKLI, ÇOCUK KORUMALI
6 WAY EARTHED SOCKET WITH CHILD PROTECTION / 6 ГНЕЗД С ЗАЗЕМЛЕНИЕМ И 3/ШТОРКОЙ



46131100

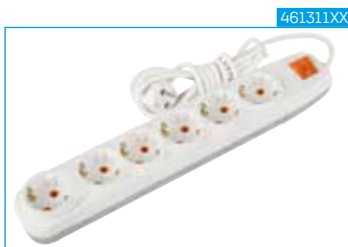

461311XX



46133100



461331XX

ALTILI TOPRAKLI, ANAHTARLI
6 WAY EARTHED SOCKET WITH SWITCH / 6 ГНЕЗД С ЗАЗЕМЛЕНИЕМ, КНОПКОЙ

ALTILI TOPRAKLI, ANAHTARLI, ÇOCUK KORUMALI
6 WAY EARTHED SOCKET WITH CHILD PROTECTION+SWITCH / 6 ГНЕЗД С ЗАЗЕМЛЕНИЕМ, КНОПКОЙ С 3/ШТОРКОЙ



GOLYAT / ADAPTOR / ТРОЙНИК



AKSESUARLAR / ACCESSORIES / АКССУАРЫ



02 - 2mt / 03 - 3mt

53130000



53130002



53130003



ÜÇLÜ TOPRAKSIZ
3 WAY SOCKET / 3 ГНЕЗДА БЕЗ ЗАЕМЛЕНИЯ

53131000



53131002



53131003



ÜÇLÜ TOPRAKSIZ ANAHTARLI
3 WAY SOCKET WITH SWITCH / 3 ГНЕЗДА БЕЗ ЗАЕМЛЕНИЯ, КНОПКОЙ

53130100



53130102



53130103



ÜÇLÜ TOPRAKLI
3 WAY EARTHED SOCKET / 3 ГНЕЗДА С ЗАЕМЛЕНИЕМ

53131100



53131102



53131103



ÜÇLÜ TOPRAKLI, ANAHTARLI
3 WAY EARTHED SOCKET WITH SWITCH / 3 ГНЕЗДА С ЗАЕМЛЕНИЕМ, КНОПКОЙ

56130100



56130102



56130103



ALTI LI TOPRAKLI
6 WAY EARTHED SOCKET / 6 ГНЕЗД С ЗАЕМЛЕНИЕМ

56131100



56131102



56131103



ALTI LI TOPRAKLI, ANAHTARLI
6 WAY EARTHED SOCKET WITH SWITCH / 6 ГНЕЗД С ЗАЕМЛЕНИЕМ, КНОПКОЙ



24 XX 04 01
Anahtar
One Way Switch
Выключатель



24 XX 04 02
Işıklı Anahtar
Illuminated One Way Switch
Выключатель с Подсветкой



24 XX 04 03
Komitatör
Double One Way Switch
Выкл. Двухклавишный

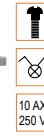

24 XX 04 04
Işıklı Komitatör
Illumin. Double One Way Switch
Выкл. 2-х Клавиш. с Подсвет.



24 XX 04 66
Üçlü Anahtar
Triple Switch
Выкл. Трёхклавишный



24 XX 04 05
Light Anahtar
Light Switch
Выключатель Кнопка



24 XX 04 06
Işıklı Light Anahtar
Illuminated Light Switch
Выкл. Кнопка с Подсвет.



24 XX 04 07
Vavien
Two Way Switch
Выключатель Проходной



24 XX 04 08
Işıklı Vavien
Illuminated Two Way Switch
Выкл. Проходной с Подсветкой

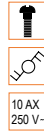

24 XX 04 09
Komitatör Vavien
Double Two Way Switch
Выкл. Двухклавишный Проход.



24 XX 04 010
Permütatör
Permutator
Выключатель Крестообразный



24 XX 04 11
Jaluzi Kumanda Anahtar
Jalousie Control Switch
Выкл. для Управления Жалюзи



24 XX 04 12
Kapı Zil Anahtar
Doorbell Switch
Кнопка Звонка



24 XX 04 13
Işıklı Kapı Zil Anahtar
Illuminated Doorbell Switch
Кнопка Звонка с Подсвет.



24 XX 04 14
Kapı Otomat. Anahtar
Door Push Switch
Кнопка Дверного Автомат. Замка



24 XX 04 15
Priz
Socket
Розетка



24 XX 04 16
Çocuk Korumalı Priz
Child Protection Socket
Розетка с З/Шторкой



24 XX 04 17
Topraklı Priz
Earthed Socket
Розетка с Заземлением

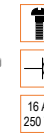

24 XX 04 18
Kapaklı Topraklı Priz
Outlet Cover Earthed Socket
Розетка с Зазем. и Крышкой



24 XX 04 19
Çocuk Korumalı Top. Priz
Child Protection Earthed Socket
Розетка с Зазем. и З/Ш.



24 XX 04 20
Çocuk Korumalı Kapaklı Top. Priz
Outlet Cover Child Protection
Earthed Socket
Розетка с Крышкой, Зазем. и 3/Ш



24 XX 04 21
UPS Priz
UPS Socket
Розетка UPS



24 XX 04 22
Çocuk Korumalı UPS Priz
Child Protection UPS Socket
Розетка UPS с 3/Шторкой



24 XX 04 23
Kapaklı UPS Priz
Outlet Cover UPS Socket
Розетка UPS с Крышкой



24 XX 10 24
İkili Priz
Two Gang Socket
Двойная Розетка



24 XX 10 25
İkili Topraklı Priz
Two Gang Earthed Socket
Двойная Розетка с Заземлением

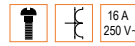

24 XX 10 26
İkili UPS Priz
Two Gang UPS Socket
Двойная Розетка UPS



24 XX 04 28
TV Priz Geçişli
TV Socket (Through of Line)
ТВ Розетка (Проходная)



24 XX 04 29
TV Priz Sonlu
TV Socket (End of Line)
ТВ Розетка (Концевая)



24 XX 04 30
TV-Radio Priz Geçişli
TV-Radio Socket (Through of Line)
ТВ-Радио Розетка (Проходная)



24 XX 04 31
TV-Radio Priz Sonlu
TV-Radio Socket (End of Line)
ТВ-Радио Розетка (Концевая)



24 XX 04 32
TV Socket Geçişli (Düşük Sinyal Kaybı)
TV Socket Through of Line
(Low Signal Loss)
ТВ Розетка Проходная
(Низкая Потеря Сигнала)



24 XX 04 33
TV Socket Sonlu (Düşük Sinyal Kaybı)
TV Socket End of Line
(Low Signal Loss)
ТВ Розетка Концевая
(Низкая Потеря Сигнала)

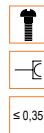

24 XX 04 34
SAT Socket Geçişli
SAT Socket Through of Line
Спутник Розетка Проходная



24 XX 04 35
Sat Socket Sonlu
SAT Socket End of Line
Спутник Розетка Концевая



24 XX 04 36
TV-SAT Socket Geçişli
TV-SAT Socket Through of Line
ТВ-Спутник Розетка Проходная



24 XX 04 37
TV-SAT Socket Sonlu
TV-SAT Socket End of Line
ТВ-Спутник Розетка Концевая

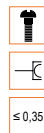

24 XX 04 38
TV-R-SAT Socket Geçişli
TV-R-SAT Socket Through of Line
ТВ-Радио-Спутник
Розетка Проходная



24 XX 04 39
TV-R-SAT Socket Sonlu
TV-R-SAT Socket End of Line-
ТВ-Радио-Спутник
Розетка Концевая



24 XX 04 40
Nümeris Telefon Prizi Rj11
Numeric Telephone Socket Rj11
Розетка Телефонная Rj11



24 XX 04 62
Numeris Telefon Prizi Cat 3-
Numeris Telephone Socket Cat 3-
Розетка Телефонная Cat 3



24 XX 04 41
İkili Numeris Telefon Prizi Rj11-
Two Gang Numeris
Telephone Socket Rj11-
Розетка Тел. Двойная Rj11



24 XX 04 44
Data Prizi Cat 5-
Data Socket Cat 5-
Компьютерная Розетка Cat 5



24 XX 04 45
Data Priz Cat 6
Data Socket Cat 6
Компьютерная Розетка Cat 6



24 XX 04 46
İkili Data Priz Cat 5
Two Gang Data Socket Cat 5
Двойная Компьютерная
Розетка Cat 5



24 XX 04 47
İkili Data Priz Cat 6
Two Gang Data Socket Cat 6
Двойная Компьютерная
Розетка Cat 6



24 XX 04 48
Data+Nüm. Tel. Prizi Cat 5/Rj11
Data+Numeric Socket Cat 5/Rj11
Розетка Комп.+Тел. Cat 5/Rj11



24 XX 04 49
Data+Nüm. Tel. Prizi Cat 6/Rj11
Data+Numeric Socket Cat 6/Rj11
Розетка Комп.+Тел. Cat 6/Rj11



24 XX 04 50
İkili Müzik Yayın Prizi
Double Music Broadcasting Socket
Аудиорозетка Двойная



24 XX 04 63
Klima Anhtarı
Air Conditioner Switch
Кондиционирование Воздуха



24 XX 04 52 - 24 XX 04 53
Dimmer Işıklı 600W - 1000W
Dimmer with Illum. 600W - 1000W
Диммер с Подсветкой 600W - 1000W



24 XX 04 54
Vavien Dimmer Işık+Sigorta+Filtre 300W
Vavien Dimmer with Illumin.+Filtr+Fuse 300W
Диммер Проход. с Подсвет. +Предохран.
+Фильтр 300W



24 XX 04 55
Dimmer Işık+Sigorta+Filtre 300W
Dimmer with Illumin.+Filtr
+Fuse 300W
Диммер с Подсвет.+Предохран.
+Фильтр 300W



24 XX 04 78
Led Dimmer 30-300W
Led Dimmer 30-300W
Лед Диммер 30-300W



24 XX 04 65
Eko F Konnektör
F Connector
Универсальная Розетка ТВ-Спутник



24 XX 04 77
HDMI Priz
HDMI Socket
HDMI Розетка



24 XX 04 76
HDMI+Data Priz
HDMI+Data Socket
HDMI+Комп. Розетка



24 XX 04 79
VGA Priz
VGA Socket
VGA Розетка



24 XX 04 81
İkili USB Priz
Double USB Socket
USB Розетка Двойная



24 XX 04 81
İkili Fiber Optik Priz
Double Fiber Optic Socket
Оптоволокно Розетка Двойная



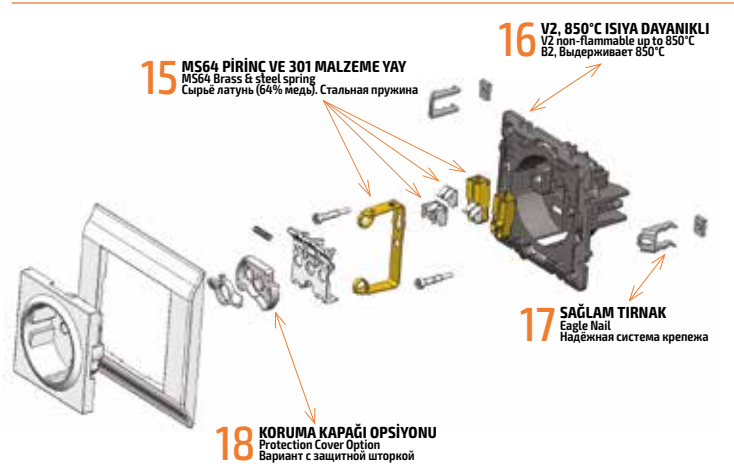
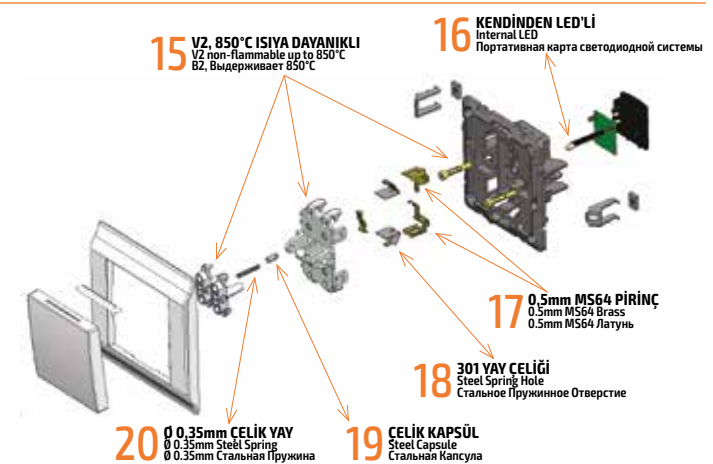
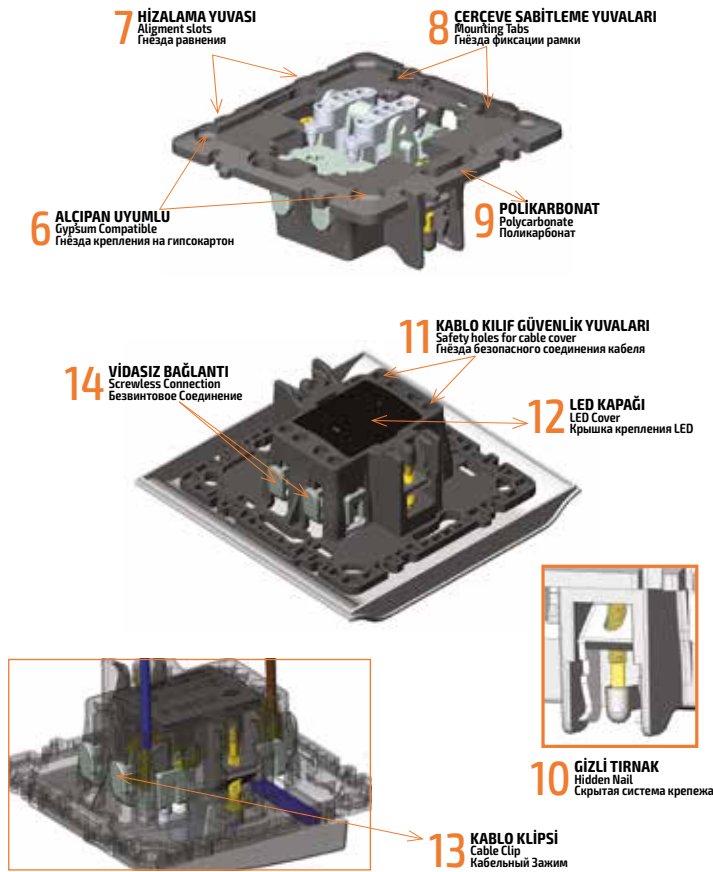
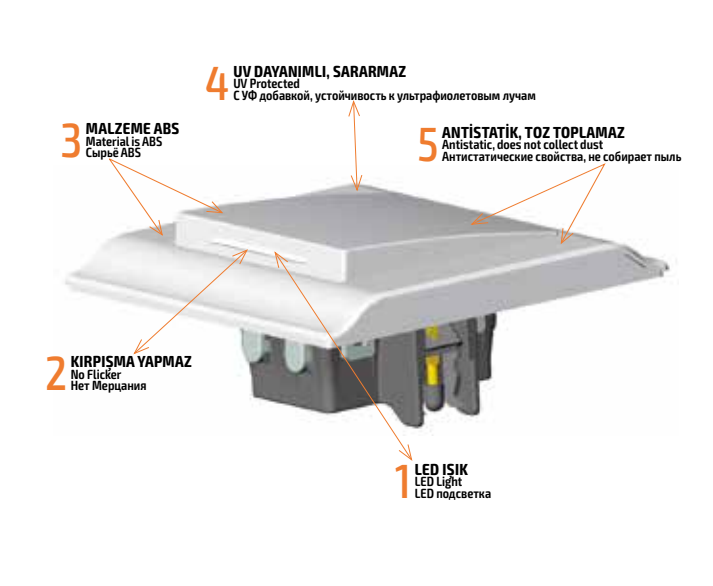

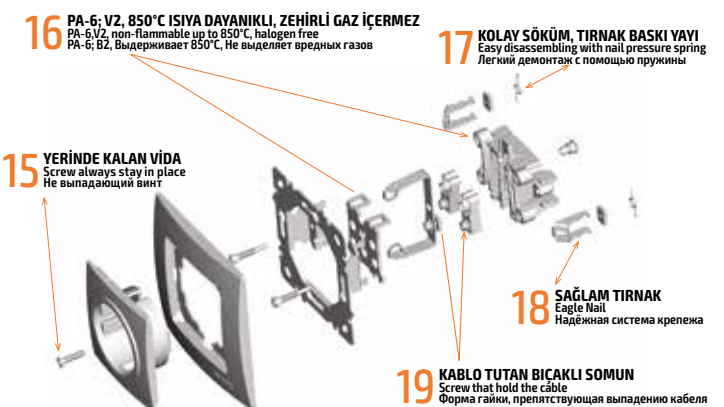
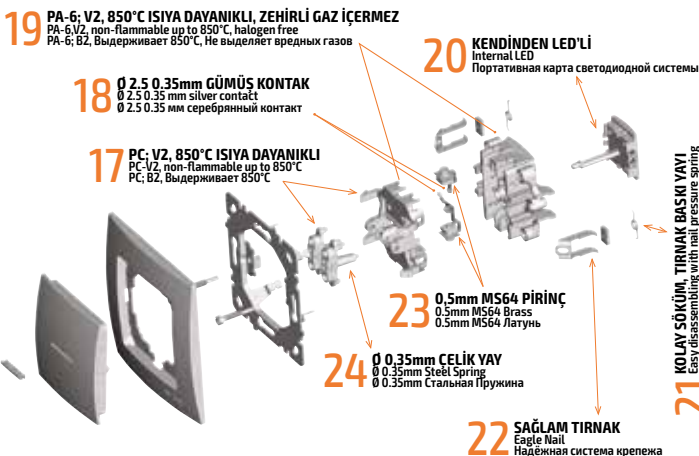
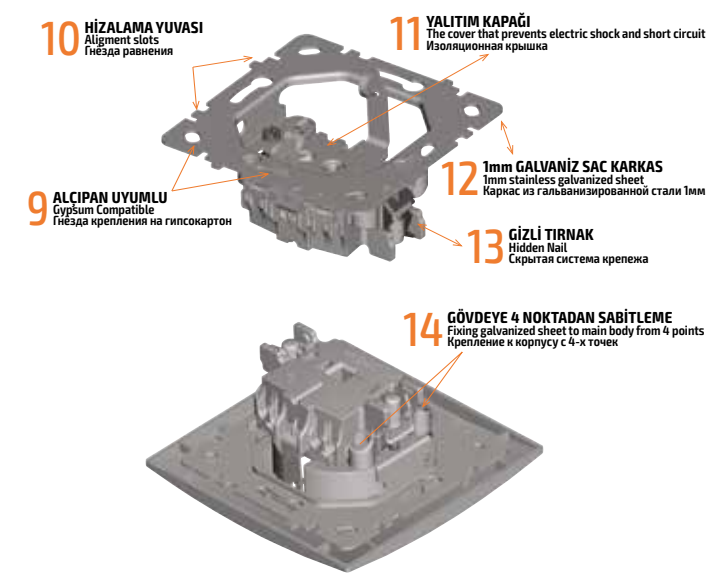
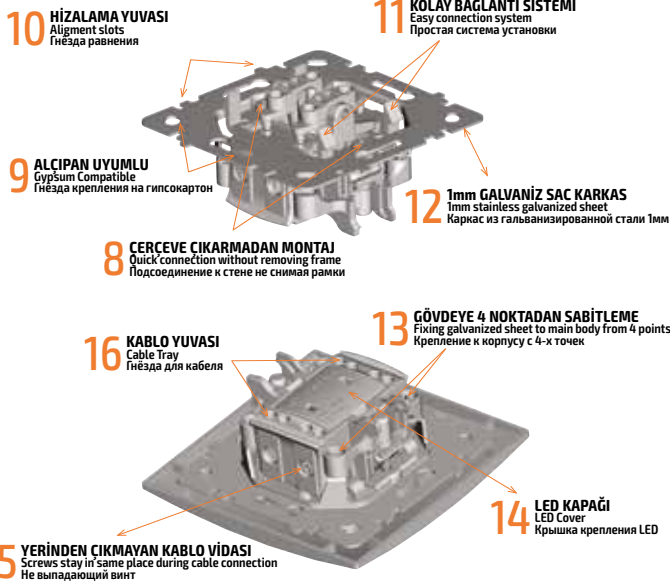
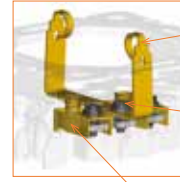
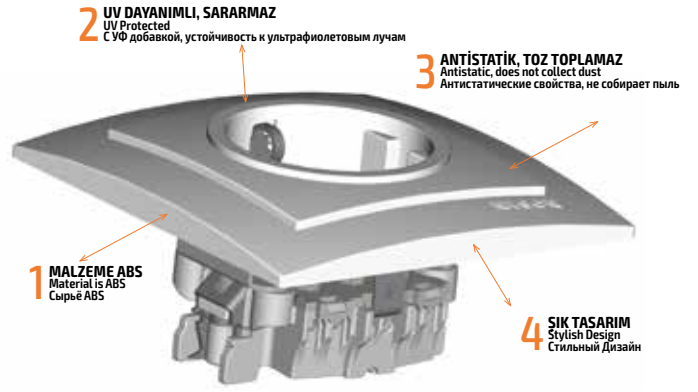
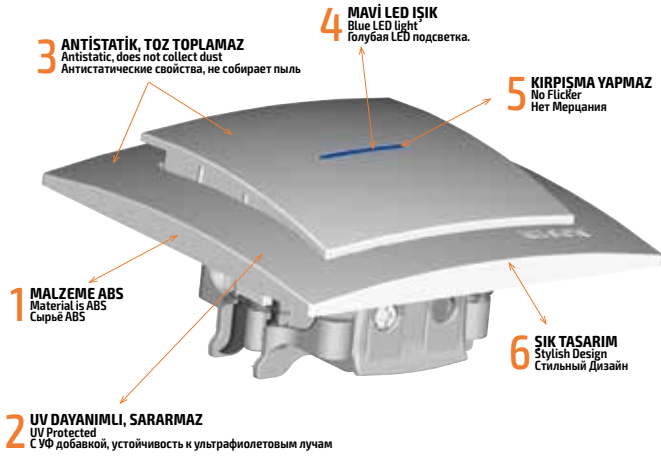

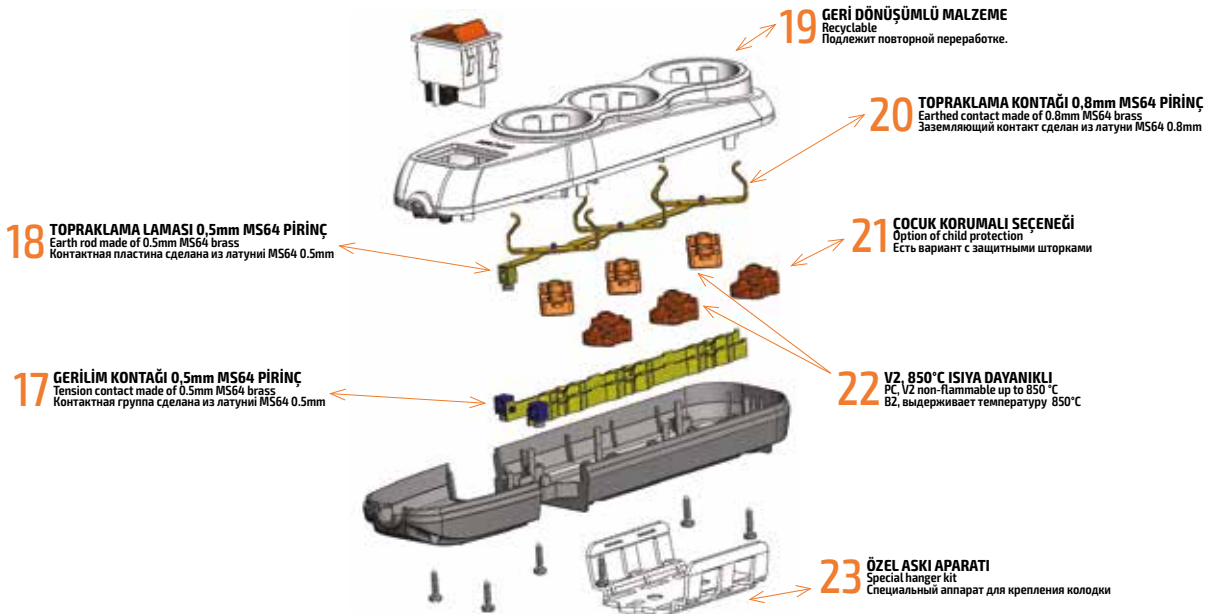
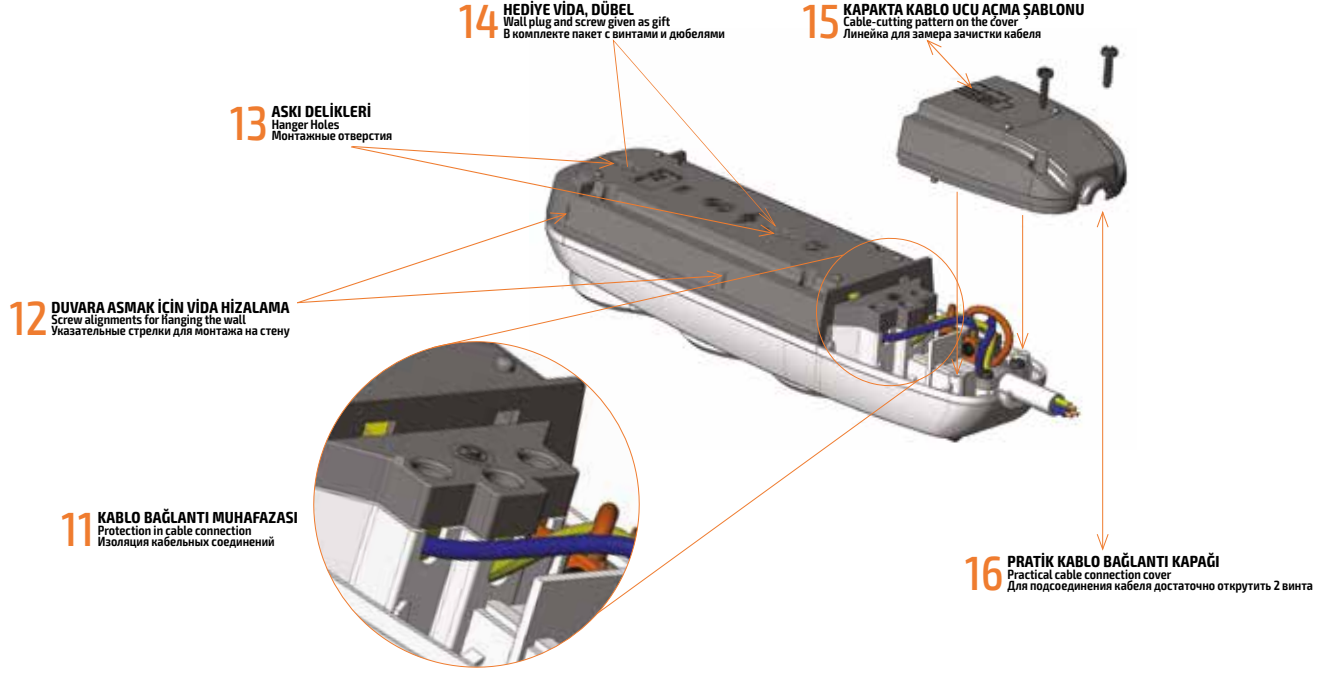
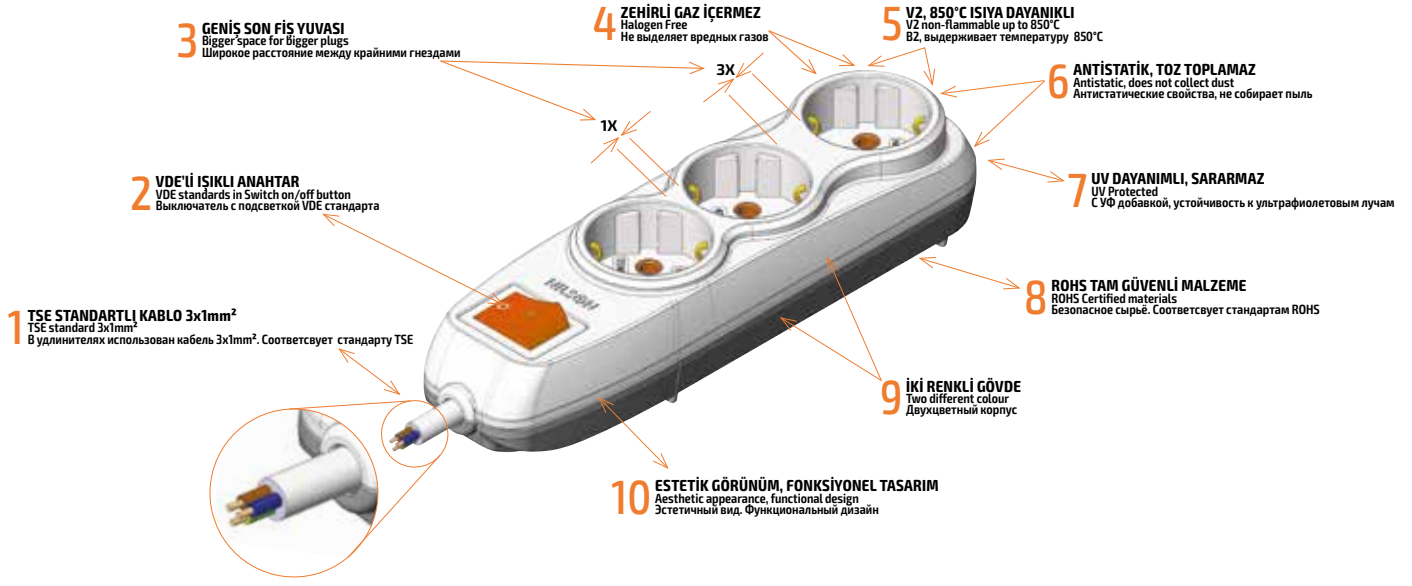

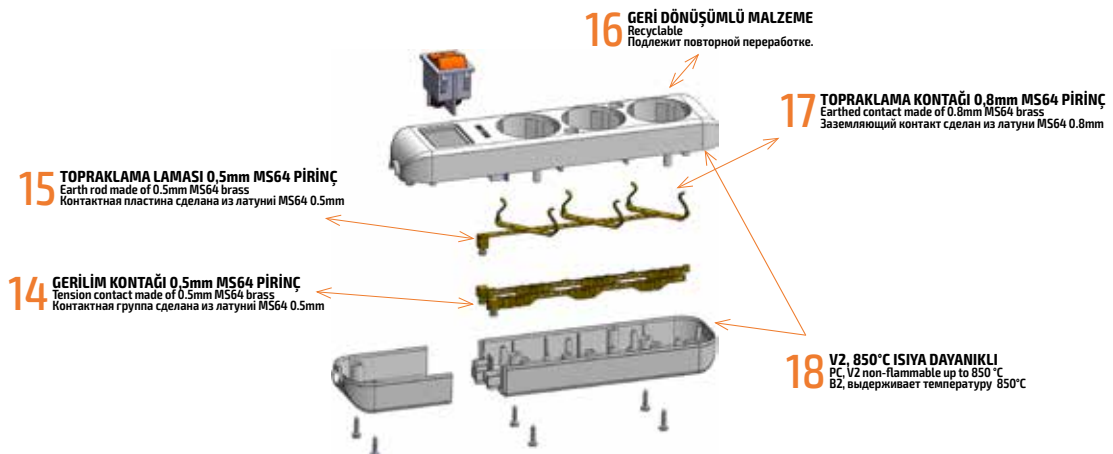
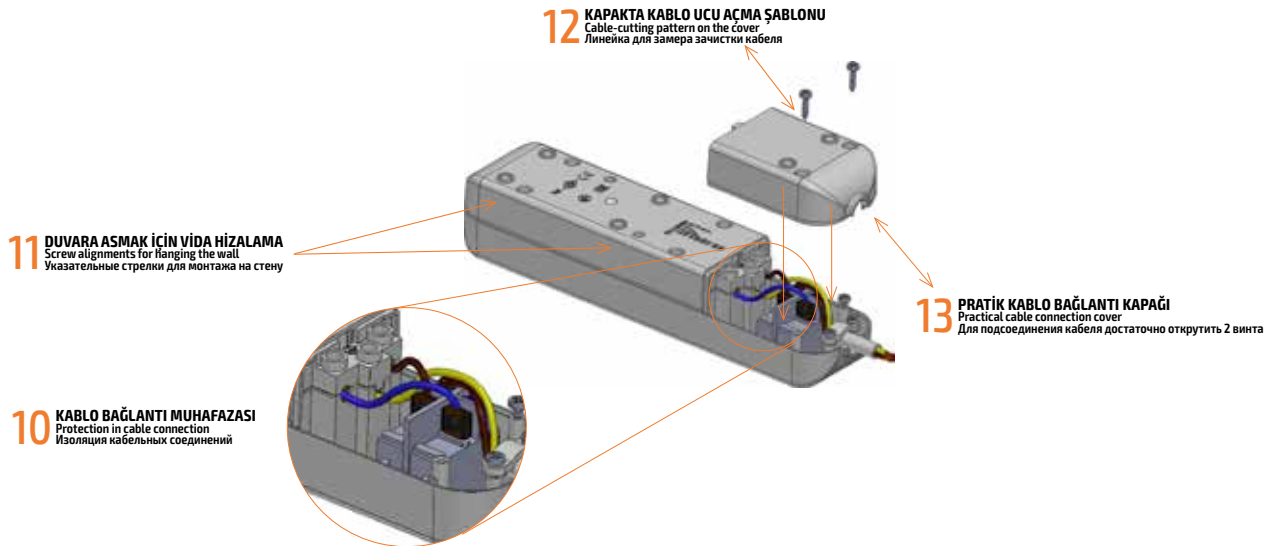
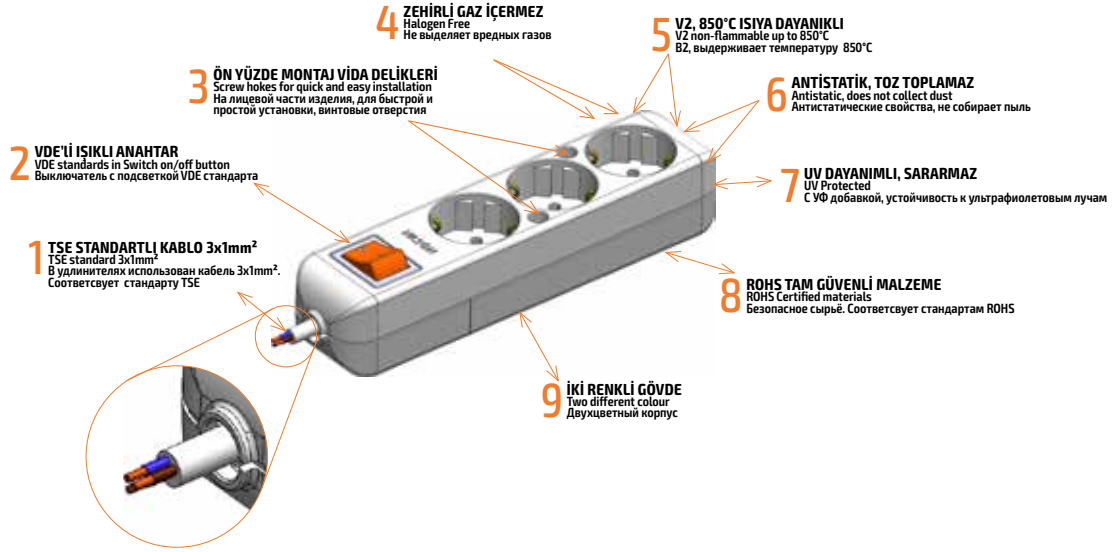

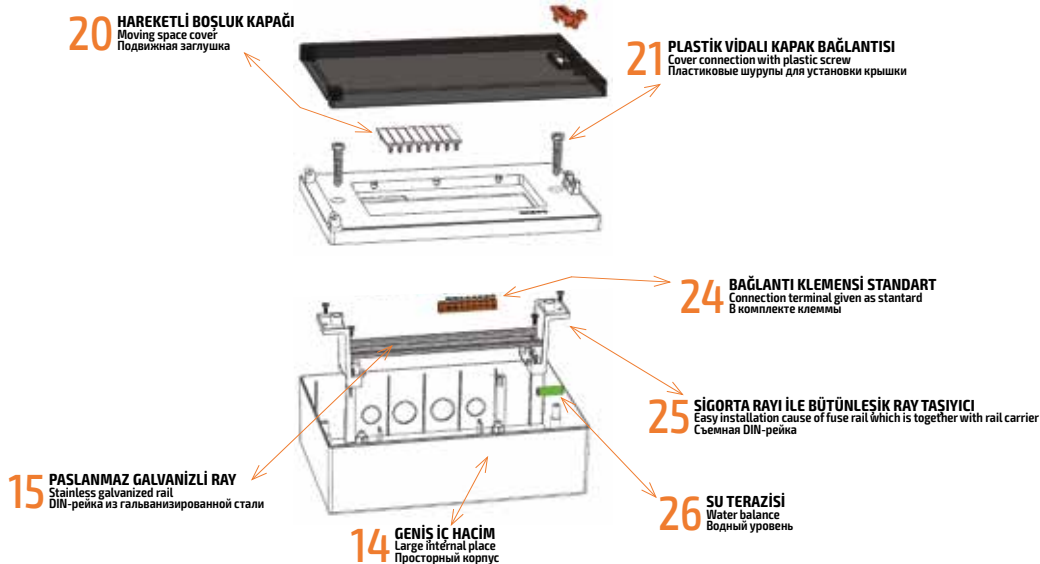
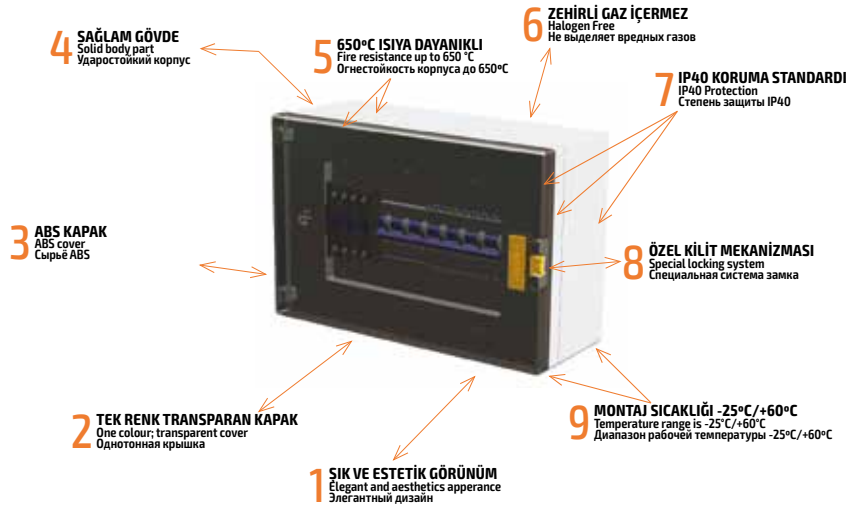



Anahtar | One Way Switch | Выключатель

| | |
|---|---|
| İşaret Symbol Знак |  |
| Bağlantı Tipi Connection Type Тип Соединения |  |
| Amper Ampere Ампер | 10 AX |
| Volt Volt Вольт | 250 V- |

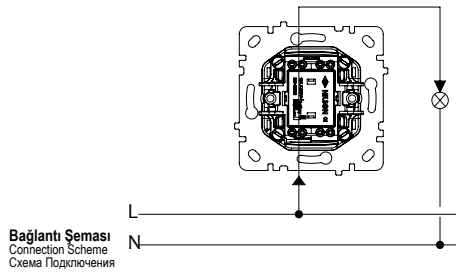

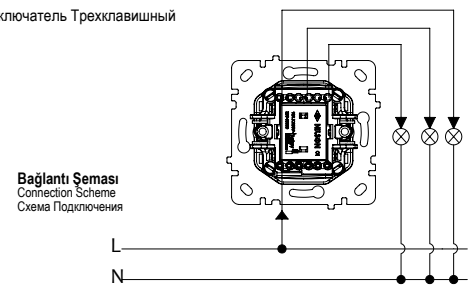

Üçlü Anahtar | Triple Switch | Выключатель Трехклавишный

| | |
|---|--|
| İşaret Symbol Знак |  |
| Bağlantı Tipi Connection Type Тип Соединения |  |
| Amper Ampere Ампер | 10 AX |
| Volt Volt Вольт | 250 V- |



İşıklı Anahtar | Illuminated One Way Switch | Выключатель с Подсветкой

| | |
|---|---|
| İşaret Symbol Знак |  |
| Bağlantı Tipi Connection Type Тип Соединения |  |
| Amper Ampere Ампер | 10 AX |
| Volt Volt Вольт | 250 V- |

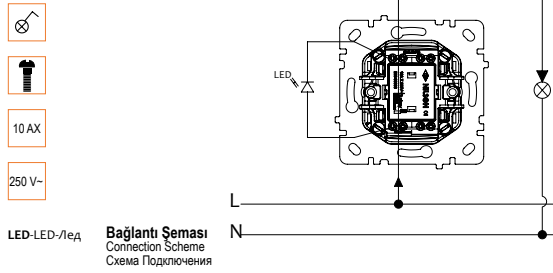

Jaluzi Kumanda Anahtarı | Jalousie Control Switch | Выключатель для Управления Жалюзи

| | |
|---|--|
| İşaret Symbol Знак |  |
| Bağlantı Tipi Connection Type Тип Соединения |  |
| Amper Ampere Ампер | 10 AX |
| Volt Volt Вольт | 250 V- |

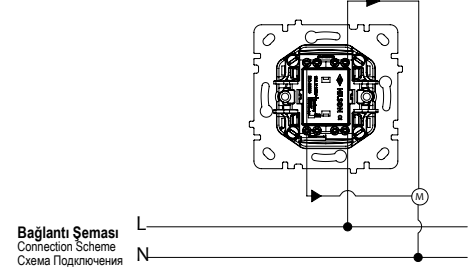

Komitatör | Double One Way Switch | Выключатель Двухклавишный

| | |
|---|--|
| İşaret Symbol Знак |  |
| Bağlantı Tipi Connection Type Тип Соединения |  |
| Amper Ampere Ампер | 10 AX |
| Volt Volt Вольт | 250 V- |

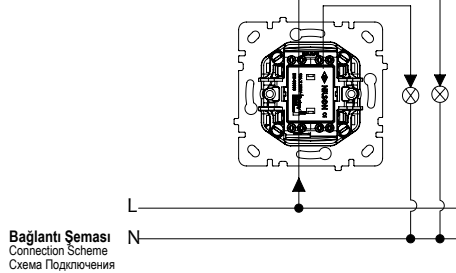

Light | Light Switch | Выключатель Кнопка

| | |
|---|---|
| İşaret Symbol Знак |  |
| Bağlantı Tipi Connection Type Тип Соединения |  |
| Amper Ampere Ампер | 10 AX |
| Volt Volt Вольт | 250 V- |

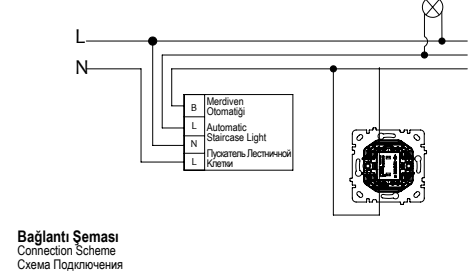

İşıklı Komitatör | Illuminated Double One Way Switch | Выключатель Двухклавишный с Подсветкой

| | |
|---|---|
| İşaret Symbol Знак |  |
| Bağlantı Tipi Connection Type Тип Соединения |  |
| Amper Ampere Ампер | 10 AX |
| Volt Volt Вольт | 250 V- |

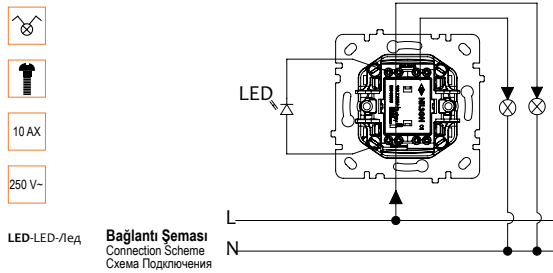

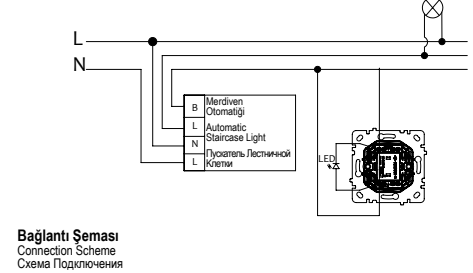

İşıklı Light | Illuminated Light Switch | Выключатель Кнопка с Подсветкой

| | |
|---|--|
| İşaret Symbol Знак |  |
| Bağlantı Tipi Connection Type Тип Соединения |  |
| Amper Ampere Ампер | 10 AX |
| Volt Volt Вольт | 250 V- |



Vavien | Two Way Switch | Выключатель Проходной

| | |
|---|---|
| İşaret Symbol Знак |  |
| Bağlantı Tipi Connection Type Тип Соединения |  |
| Amper Ampere Ампер | 10 AX |
| Volt Volt Вольт | 250 V- |

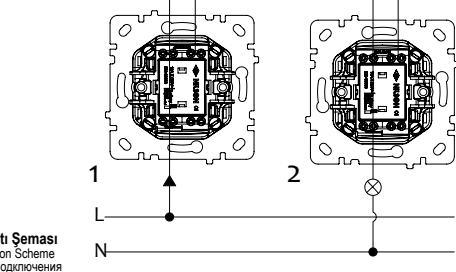

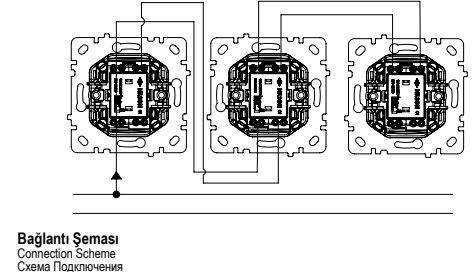

Permütatör | Permutor | Выключатель Крестообразный

| | |
|---|--|
| İşaret Symbol Знак |  |
| Bağlantı Tipi Connection Type Тип Соединения |  |
| Amper Ampere Ампер | 10 AX |
| Volt Volt Вольт | 250 V- |



Komitatör Vavien | Double Two Way Switch | Выключатель Двухклавишный Проходной

| | |
|---|---|
| İşaret Symbol Знак |  |
| Bağlantı Tipi Connection Type Тип Соединения |  |
| Amper Ampere Ампер | 10 AX |
| Volt Volt Вольт | 250 V- |

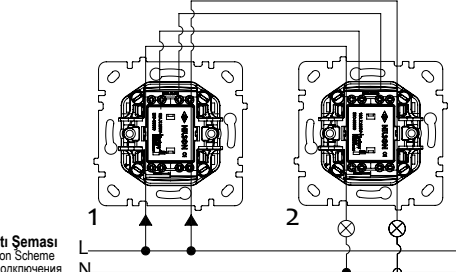

Energy Saver | Energy Saver | Электронное Устройство Отключения Электропитания

| | |
|---|--|
| İşaret Symbol Знак |  |
| Bağlantı Tipi Connection Type Тип Соединения |  |
| Amper Ampere Ампер | 0,5 A |
| Volt Volt Вольт | 250 V- |

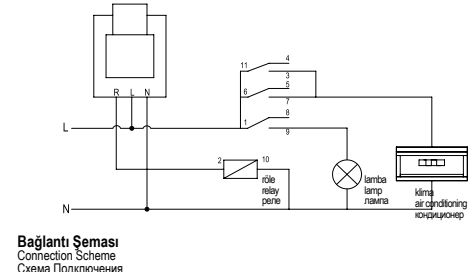

Priz | Socket | Розетка

| | |
|---|--------|
| İşaret Symbol Знак | |
| Bağlantı Tipi Connection Type Тип Соединения | |
| Amper Ampere Ампер | 16 A |
| Volt Volt Вольт | 250 V~ |

Bağlantı Şeması
Connection Scheme
Схема Подключения

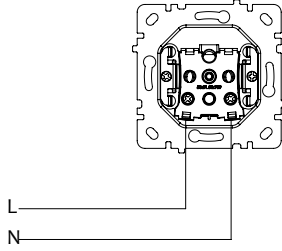

TV Prizi Geçişli | TV Socket Through of Line | Розетка ТВ Проходная

| | |
|---|--|
| İşaret Symbol Знак | |
| Bağlantı Tipi Connection Type Тип Соединения | |

Bağlantı Şeması
Connection Scheme
Схема Подключения

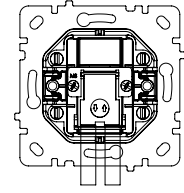

Topraklı Priz | Earthed Socket | Розетка с Заземлением

| | |
|---|--------|
| İşaret Symbol Знак | |
| Bağlantı Tipi Connection Type Тип Соединения | |
| Amper Ampere Ампер | 16 A |
| Volt Volt Вольт | 250 V~ |

Bağlantı Şeması
Connection Scheme
Схема Подключения

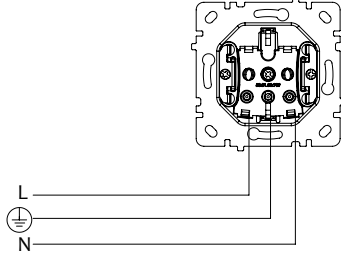

TV-SAT-R Prizi Sonlu | TV-R-SAT Socket End of Line | Розетка ТВ-Радио-Спутник Концевая

| | |
|--------------------------------------|--------|
| İşaret Symbol Знак | |
| Desibel Decibel Децибел | ≤ 0,35 |

Bağlantı Şeması
Connection Scheme
Схема Подключения

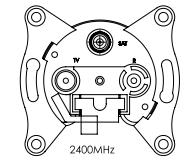

İkili Priz | Two-Gang Socket | Двойная Розетка

| | |
|---|--------|
| İşaret Symbol Знак | |
| Bağlantı Tipi Connection Type Тип Соединения | |
| Amper Ampere Ампер | 16 A |
| Volt Volt Вольт | 250 V~ |

Bağlantı Şeması
Connection Scheme
Схема Подключения

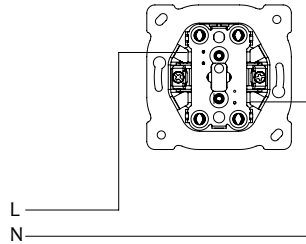

Data Prizi Cat 5, Cat 6 | Data Socket Cat 5, Cat 6 | Розетка Компьютерная Cat 5, Cat 6

| | |
|---|--|
| İşaret Symbol Знак | |
| Bağlantı Tipi Connection Type Тип Соединения | |

Bağlantı Şeması
Connection Scheme
Схема Подключения

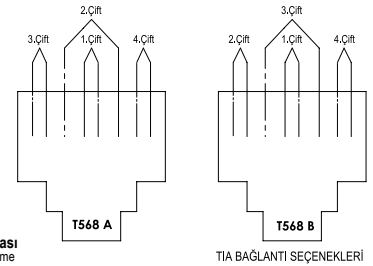

İkili Topraklı Priz | Earthed Two-Gang Socket | Двойная Розетка с Заземлением

| | |
|---|--------|
| İşaret Symbol Знак | |
| Bağlantı Tipi Connection Type Тип Соединения | |
| Amper Ampere Ампер | 16 A |
| Volt Volt Вольт | 250 V~ |

Bağlantı Şeması
Connection Scheme
Схема Подключения

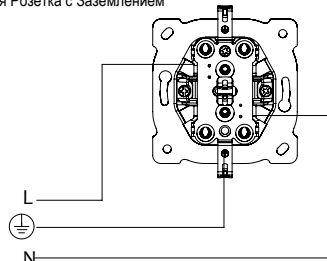

Nümeris Telefon Prizi RJ11 | Numeric Telephone Socket RJ11 | Розетка Телефонная RJ11

| | |
|---|--|
| İşaret Symbol Знак | |
| Bağlantı Tipi Connection Type Тип Соединения | |

Bağlantı Şeması
Connection Scheme
Схема Подключения

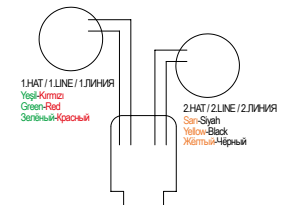

UPS Topraklı Priz | UPS Earthed Socket | Розетка с Заземлением UPS

| | |
|---|--------|
| İşaret Symbol Знак | |
| Bağlantı Tipi Connection Type Тип Соединения | |
| Amper Ampere Ампер | 16 A |
| Volt Volt Вольт | 250 V~ |

Bağlantı Şeması
Connection Scheme
Схема Подключения

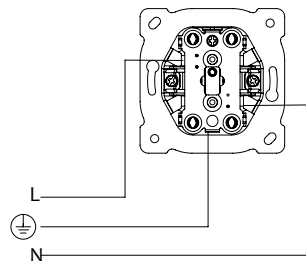

Eko F Konnektör | F Connector | Универсальная Розетка ТВ, Спутник

| | |
|---|--|
| İşaret Symbol Знак | |
| Bağlantı Tipi Connection Type Тип Соединения | |

Bağlantı Şeması
Connection Scheme
Схема Подключения

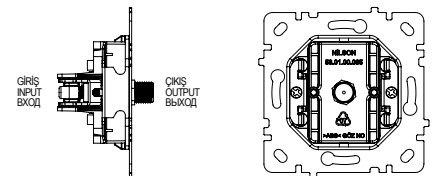

İkili UPS Topraklı Priz | Two-Gang UPS Earthed Socket | Двойная Розетка с Заземлением UPS

| | |
|---|--------|
| İşaret Symbol Знак | |
| Bağlantı Tipi Connection Type Тип Соединения | |
| Amper Ampere Ампер | 16 A |
| Volt Volt Вольт | 250 V~ |

Bağlantı Şeması
Connection Scheme
Схема Подключения

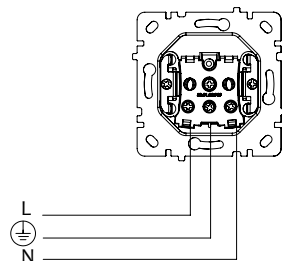

Dimmer Işıklı | Dimmer With Illuminated | Светорегулятор с подсветкой

| | |
|---|--------|
| İşaret Symbol Знак | |
| Bağlantı Tipi Connection Type Тип Соединения | |
| Güç Watt Ватт | 1000 W |
| Volt Volt Вольт | 250 V~ |

Bağlantı Şeması
Connection Scheme
Схема Подключения

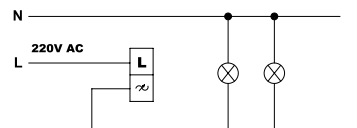

NILSON®

sihirli dokunuş...

magic touch...

магическое прикосновение...



ISO 9001:2015

